

TASCAM

VCDOC0035C

VS-R264

VIDEO STREAMER/RECORDER

VS-R265

4K/UHD VIDEO STREAMER/RECORDER

REFERENCE MANUAL

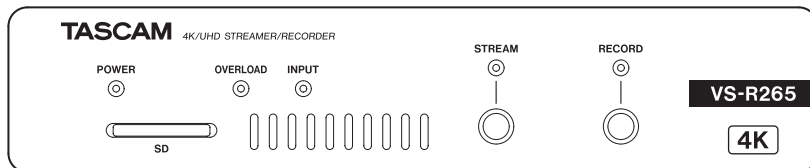
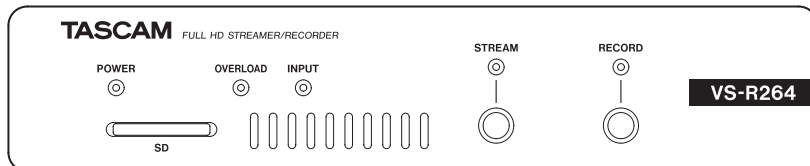

Contents

1 - Introduction	3
Features.....	3
Conventions used in this manual.....	3
Trademarks.....	3
2 - Names and Functions of Parts	4
Front panel.....	4
Rear panel.....	5
3 - Preparation	6
Installing the attachment brackets	6
Installing on or under a desk.....	6
Connecting Euroblock plugs	6
Connecting other equipment	7
Connecting the power.....	7
Inserting and removing SD card	8
Inserting SD card	8
Removing SD card.....	8
SD card write protection.....	8
Connecting and disconnecting USB storage.....	8
Connecting USB storage.....	8
Disconnecting USB storage.....	8
4 - Using Streaming Dashboard	9
Overview.....	9
Installing TASCAM DISCOVERY.....	9
Connecting Streaming Dashboard to a VS-R264/VS-R265	9
Screen overviews.....	10
Tab Area overview.....	10
Encoder Control page	11
Video Profile - Encoder Video Settings.....	12
Audio Profile - Encoder Audio Settings.....	13
Outputs - Streaming and Recording	14
Stream Output Settings.....	14
Decoder Control page.....	18
Decoder Stream	18
Decoder Audio Settings.....	20
Confidence Monitor	20
Device Settings page.....	21
General Settings	21
Security Settings.....	21
Network Settings.....	22
NTP Settings.....	22
Advanced page.....	23
5 - Hardware Reset Function	24
6 - Specifications	25
Inputs and outputs.....	25
Video inputs and outputs	25
Audio inputs and outputs	25
Control input/output	25
Audio performance	26
Other	26
Dimensional drawings.....	27

Features

- Streams Full HD (1920x1080p) video signals encoded to H.264 (VS-R264)
- Streams 4K UHD (3840x2160p) video signals encoded to H.265 (VS-R265)
- Decodes streaming video signals
 - Full HD (1920x1080p): VS-R264
 - 4K UHD (3840x2160p): VS-R265
- Compatible with major streaming protocols such as RTMP, RTSP and HLS
- Unicast and Multicast streaming support
- Equipped with balanced analog Euroblock connectors for audio I/O
- Reference level switching function and output level configuration function installed
- Recorder function installed
- Records video data directly to 16GB Internal Storage, SD cards or USB drives
- External video storage via USB 3.0
- Uploads recorded files on Internal Storage, SD cards or external storages up to FTP servers
- Web browser based remote control to configure unit settings
- Supports 100Mbps and Gigabit Ethernet
- Supports PoE Plus (Class 4) (Power over Ethernet Plus). Power supply also can be done by the optional AC adapter (TASCAM PS-P1220E: sold separately)
- Compact half-rack size. Included surface rack mountable angles allow installation on different usage scenes and environments

Note about computer operation

If you are unsure about anything related to the basic operation of a computer when it is mentioned in an explanation in this manual, please refer to the computer operation manual.

To use this unit with a computer, dedicated software must be installed on the computer.

For details about software installation, see "Installing TASCAM DISCOVERY" on page 9.

Conventions used in this manual

The following conventions are used in this manual.

- SD/SDHC memory cards are called "SD cards".
- "USB flash drives" are sometimes called "USB drives".
- The device that is currently selected is called the "current device".
- As necessary, additional information is provided under TIP, NOTE and CAUTION headings.

TIP

These are tips about how to use the unit.

NOTE

These provide additional explanations and describe special cases.

ATTENTION

Failure to follow these instructions could result in damage to equipment or lost data, for example.

CAUTION

Failure to follow these instructions could result in injury.

Trademarks

- TASCAM is a registered trademark of TEAC Corporation.
- The terms HDMI and HDMI High-Definition Multimedia Interface, and the HDMI Logo are trademarks or registered trademarks of HDMI Licensing LLC in United States and other countries.
- Covered by one or more claims of the HEVC patents listed at patentlist.accessadvance.com.



- The SDHC logo is a trademark of SD-3C, LLC.



- Microsoft, Windows and Windows Vista are either registered trademarks or trademarks of Microsoft Corporation in the United States and/or other countries.
- Apple, Mac, macOS, iPad, Lightning, App Store and iTunes are trademarks of Apple Inc.
- Google Chrome are trademarks of Google Inc.
- Other company names, product names and logos in this document are the trademarks or registered trademarks of their respective owners.

Information is given about products in this manual only for the purpose of example and does not indicate any guarantees against infringements of third-party intellectual property rights and other rights related to them. TEAC Corporation will bear no responsibility for infringements on third-party intellectual property rights or their occurrence because of the use of these products.

With the exception of personal enjoyment and similar uses, copyrighted materials belonging to third parties cannot be used without permission from the rights holders in accordance with copyright law. Please use the equipment appropriately. TEAC Corporation will bear no responsibility for rights infringements committed by users of this product.

Creative works as picture images, movies, music and others are to be protected by applicable copyright laws, and when you intend to use those works in recording, reproducing, broadcasting or other means for the purpose of commercial use, you are required to obtain the license by copyright owners therefor. The license terms might be different in each occasion and the copyright owner. Please be advised that you contact your content service providers and/or applicable copyright management organization.

2 - Names and Functions of Parts

Front panel

VS-R264

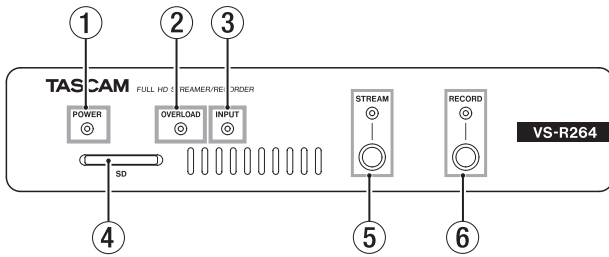

VS-R265

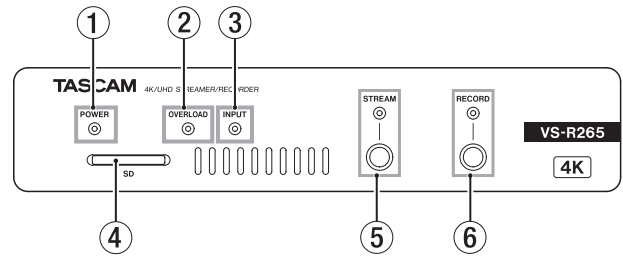

① POWER indicator

This shows whether the power is on or off.

	Status	Meaning
Power is off	Unlit	
Power is on	Lit blue	Ordinary operation

NOTE

If a switching hub that supports PoE power supply rather than PoE Plus (Class 4) is connected, the OVERLOAD, INPUT, STREAM and RECORD indicators will light Red and flash.

② OVERLOAD indicator

This lights when analog audio input signals reach 3 dB below the maximum input level.

③ INPUT indicator

This shows the status of signal input from an HDMI source device.

Status	Meaning
Lit blue	Ordinary operation
Blinking red	Invalid signal

④ SD card slot

Insert SD card in this slot. (see "Inserting and removing SD card" on page 8)

⑤ STREAM button and indicator

Press this button to turn all RTMP streaming outputs on and off. (see "RTMP 1/2/3 Output Settings" on page 14)

This indicator shows the streaming status of this unit.

Status	Meaning
Unlit	The streaming output functions are disabled (off).
Blinking red	The streaming output functions are enabled, but they have no streaming data.
Blinking blue	Attempting to connect to RTMP server.
Blinking blue/red	Error connecting to RTMP server.
Lit blue	Streaming is occurring normally.

NOTE

The STREAM button controls all 3 x RTMP streaming outputs, but does not affect the other stream outputs (i.e. HTTP Pull, Multicast, Unicast or RTSP).

⑥ RECORD button and indicator

Press this button to start recording to external storage if it is available. (see "Recording and FTP Settings" on page 17)

Press this button during recording to stop recording.

This indicator shows the status of recording to external storage.

Status	Meaning
Unlit	Recording is stopped.
Blinking red	The recording medium is full or unavailable. Or, there is no input from an HDMI source device.
Lit red	Recording is in progress.

Rear panel

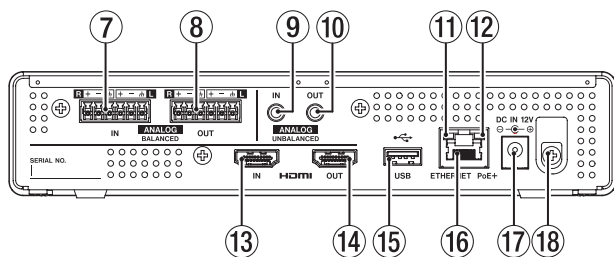

⑦ ANALOG BALANCED IN L/R connectors

These are balanced Euroblock analog audio input connectors. (HOT, COLD, GND from the left)

⑧ ANALOG BALANCED OUT L/R connectors

These are balanced Euroblock analog audio output connectors. (HOT, COLD, GND from the left)

⑨ ANALOG UNBALANCED IN connector

This stereo mini jack is an analog audio input.

⑩ ANALOG UNBALANCED OUT connector

This stereo mini jack is an analog audio output.

⑪ Link status/activity indicator

Orange indicates that a gigabit Ethernet link has been established.

⑫ Gigabit link status indicator

Green indicates that a link is established between the devices. Blinking indicates that signals are being transmitted between the devices.

⑬ HDMI IN port

Connect a DSLR camera or other HDMI source device here.

⑭ HDMI OUT port

Connect an HDMI monitor or other HDMI sync device here.

NOTE

The HDMI Out port is the output of the VS-R264/VS-R265 Decoder, and does not provide an HDMI Thru function. It can be used as a Confidence Monitor of the encoding function, by setting the Decoder to decode a video stream produced by the VS-R264/VS-R265 Encoder. (see "Confidence Monitor" on page 20)

⑮ USB port

Connect (and disconnect) USB storage here. (see "Connecting and disconnecting USB storage" on page 8)

⑯ ETHERNET/PoE+ connector

This is an Ethernet port.

Use this to connect to a network, transfer data and control the unit externally.

Power is received through this connection when connected to a switching hub that supports PoE Plus (Class 4) power supply. (see "Connecting the power" on page 7)

⑰ DC IN 12V connector

Connect a PS-P1220E AC adapter (sold separately) here when connected to a switching hub that does not support PoE Plus (Class 4) power supply.

⑱ Cord holder

When using a PS-P1220E AC adapter (sold separately), hook its cord here to prevent accidental disconnection.

3 - Preparation

Installing the attachment brackets

By installing the included attachment brackets on this unit, you can fix it in place on top of or underneath a desk, for example.

1. Remove the four screws installed in the left and right sides of the enclosure.

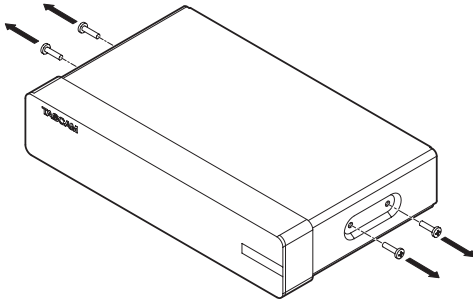

2. Align the included attachment brackets with the enclosure.

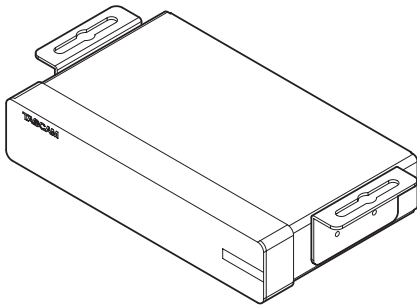

NOTE

When installing this unit on a desk, align the brackets as shown in the illustration below.

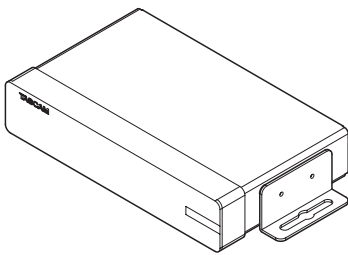

3. Use the four removed screws to install the attachment brackets on the unit.

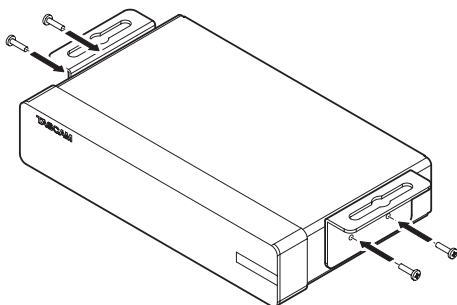

Installing on or under a desk

To install this unit on or under a desk, use 4 commercially-available screws that are suitable for the material and thickness of the desk.

NOTE

The width of the attachment bracket openings is 7.1 mm. See the dimensional diagrams at the end of this manual for details about the attachment brackets.

1. With the two attachment brackets already installed on the unit, align the unit with the desk as desired.
2. Make marks where the screw holes will be made in the desk.
3. Drill pilot holes for the screws in the desk.
4. Attach the unit to the desk with 4 screws.

Connecting Euroblock plugs

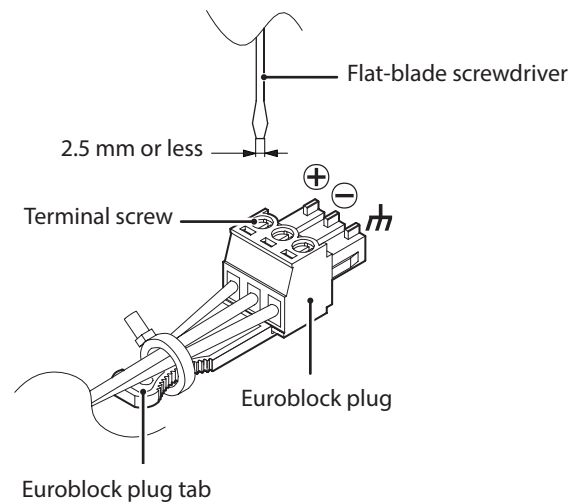

1. Loosen the Euroblock plug terminal screws.

NOTE

Use a flat-blade screwdriver with a width of 2.5mm or less.

2. Insert wires.

NOTE

AWG16–AWG28 wires are compatible with the included Euroblock plugs. Using wires within the compatible range, trim about 7 mm of the protective sheaths from their ends.

3. Tighten the Euroblock plug terminal screws.

NOTE

Confirm that the wires cannot be pulled out.

4. Use an included wire band to attach the wires to the Euroblock plug tab.

Connecting other equipment

This is an example of VS-R264/VS-R265 connections.

Precautions before making connections

- Carefully read the operation manuals of the devices to be connected and then connect them correctly.
- Before making connections, turn this unit and all equipment to be connected off (standby).
- Install all connected devices, including this unit, so that they are powered from the same line. When using a power strip or similar device, be sure to use one that has high current capacity (thick cable) in order to minimize fluctuations in power voltage.

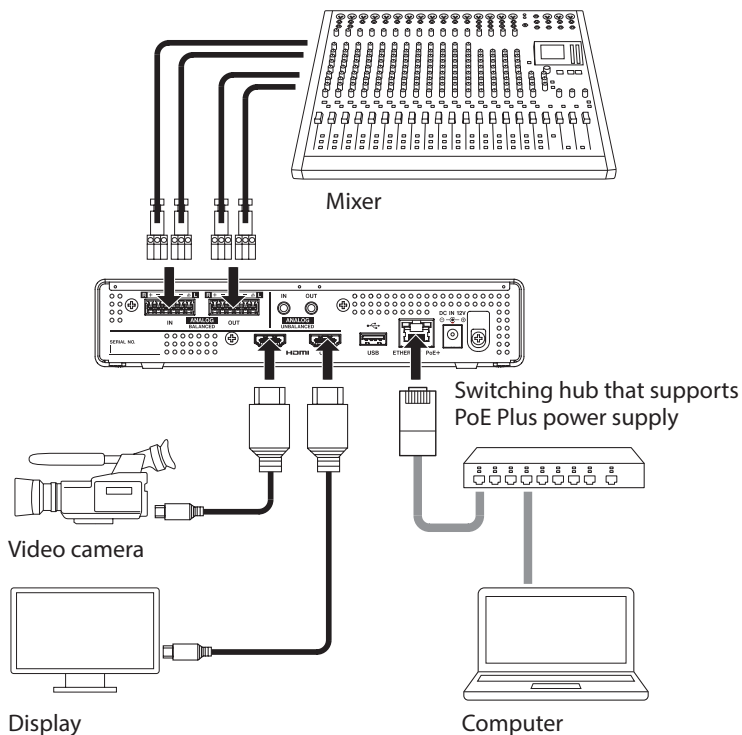

Connecting the power

Connect a switching hub that supports PoE Plus (Class 4) power supply or use a dedicated PS-P1220E AC adapter (sold separately) to power this unit.

Supplying power with PoE Plus (Class 4)

Using a category 5E or higher LAN cable, connect the VS-R264/VS-R265 to a switching hub that supports PoE Plus (Class 4) power supply.

NOTE

- Basic PoE does not provide sufficient power to properly operate the VS-R264/VS-R265 unit, so if the switching hub provides only PoE and not PoE Plus (Class 4), the OVERLOAD, INPUT, STREAM and RECORD indicators on the front panel will flash Red.
- To connect to a switching hub that does not support PoE Plus (Class 4) power supply, use a dedicated PS-P1220E AC adapter (sold separately) to supply power.

ATTENTION

Do not connect the dedicated PS-P1220E AC adapter when using PoE Plus power supply.

Supplying power with a dedicated AC adapter

Connect a TASCAM PS-P1220E AC adapter (sold separately) to the unit's DC IN 12V connector the unit.

ATTENTION

Never use any adapter other than the designated PS-P1220E AC adapter. Use of a different adapter could cause malfunction, fire or electric shock.

3 - Preparation

Inserting and removing SD card

Inserting SD card

Insert an SD card into an SD card slot on the front of the unit to enable it to record.

NOTE

SD cards can be inserted whether or not the unit is on or off.

- Inserted SD card with the correct orientation.
- The label should be up and the connector should be inserted toward the back.

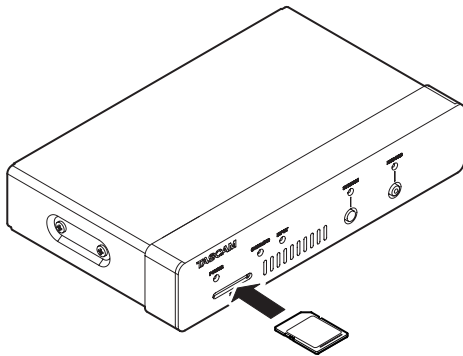

Removing SD card

After selecting the SD card on the Storage Device Management screen and pressing the **Safely Remove** button, remove the SD card. (see "Advanced page" on page 23)

ATTENTION

Never remove an SD card when data is being written. Doing so could cause data to be lost.

1. Press the SD card in gently to make it to come forward.

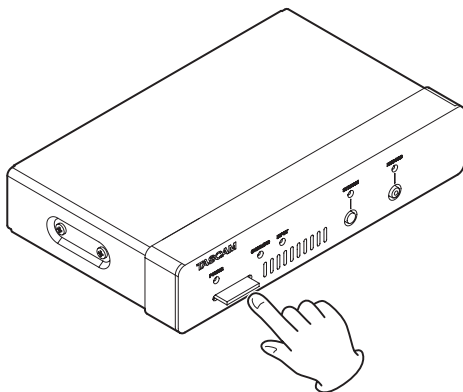

2. Pull the SD card out by hand.

SD card write protection

SD cards have write-protection switches that prevent writing new data to them.

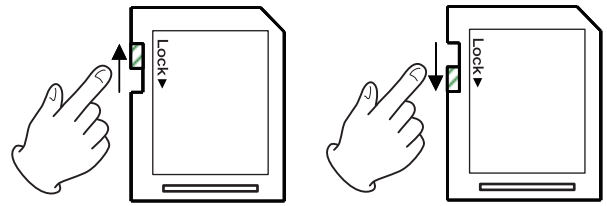

If you slide the protection switch to the "LOCK" position, recording will not be possible. Unlock cards to enable recording.

Connecting and disconnecting USB storage

Connecting USB storage

Connect USB storage to the USB port on the back of the unit to enable recording.

NOTE

You can connect USB storage when the unit is on or off.

Disconnecting USB storage

After selecting the USB storage device on the Storage Device Management screen and pressing the **Safely Remove** button, remove the USB storage device. (see "Advanced page" on page 23)

ATTENTION

Never disconnect USB storage when data is being written. Doing so could cause data to be lost.

4 - Using Streaming Dashboard

Overview

To control this unit, use the IP address assigned to it to log in with the user interface from a browser.

TASCAM DISCOVERY

TASCAM DISCOVERY is an application that detects VS-R264 and VS-R265 units on the network. It is available for Windows, Mac and Linux computers.

Streaming Dashboard

Streaming Dashboard is a browser-based user interface. This interface can control VS-R264 and VS-R265 units on the network.

ATTENTION

Install Google Chrome in advance and set it as the default web browser.

Installing TASCAM DISCOVERY

Install the TASCAM DISCOVERY application that is on the included USB flash drive.

1. Connect the included USB flash drive to a computer.
2. Open the "Setup" folder on the USB flash drive.
3. Select the file for the operating system being used and install TASCAM DISCOVERY.

Windows

Double-click "TASCAM DISCOVERY_App_2.0_Windows.exe" to install it.

Mac

Double-click the "TASCAM DISCOVERY_App_2.0_MacOs.dmg" file, and follow the instructions on the screen that appears to drag the icon and install it.

Linux

Uncompress "TASCAM DISCOVERY_App_2.0_Linux-x64.tar.gz" and follow the procedures in "README-linux" to install it.

Connecting Streaming Dashboard to a VS-R264/VS-R265

1. Connect the VS-R264 /VS-R265 to a router with a LAN cable through a switching hub that supports PoE Plus (Class 4) power supply, or if no PoE Plus is provided by the network switching hub, use the optional external TASCAM PS-P1220E AC adapter.

2. Connect the computer that will control the VS-R264/VS-R265 to the network by Wi-Fi or with a wired connection.

ATTENTION

Connect the VS-R264/VS-R265 and the computer that will control it to the same router.

If connections are made through multiple hubs and routers, the app might not be able to detect devices on the network.

Even when the VS-R264/VS-R265 and the controlling computer are connected to the same hub or router, detection might not be possible depending on the model being used.

For further information, please contact your network administrator.

3. The following screen will appear when TASCAM DISCOVERY is launched.

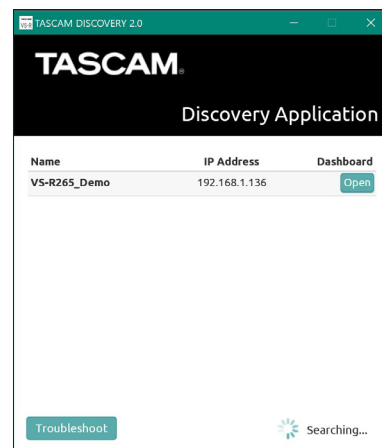

If multiple VS-R264/VS-R265 units are connected by LAN, they will all appear on the login screen.

NOTE

- The TASCAM DISCOVERY version is shown at the top left of this screen.
- If the VS-R264/VS-R265 is off or it cannot be detected on the network, the following screen will appear.

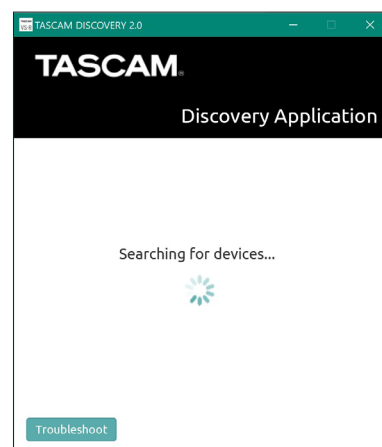

4 - Using Streaming Dashboard

- Click the “Open” button for the VS-R264/VS-R265 you want to connect.

Select the VS-R264/VS-R265 that you want to set or check and log in to it.

When connection between the VS-R264/VS-R265 and the controlling computer is confirmed, the Streaming Dashboard Encoder Control screen will open.

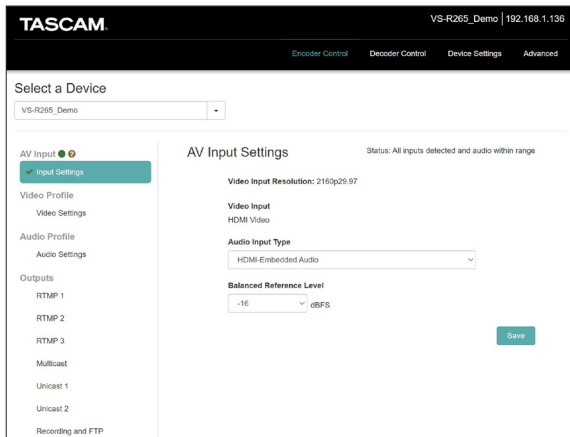

NOTE

Click the “Open” button in TASCAM DISCOVERY for a VS-R264/VS-R265 to make it the current device.

TIP

When using multiple VS-R264/VS-R265 units on the network, you can connect to each one individually in the Streaming Dashboard by using the ‘Select a Device’ dropdown menu. Identifying VS-R264/VS-R265 units can be made easier by giving each its own name. (see “General Settings” on page 21)

If a unit cannot be found using TASCAM DISCOVERY

If a unit cannot be found when using TASCAM DISCOVERY, follow these procedures to connect it using Streaming Dashboard.

Turn the unit on and get the IP address and other network information for it.

- Connect a USB flash drive or SD card.
- Disconnect the USB flash drive or SD card after waiting about 30 seconds.
A “streaming_network_configurations.txt” file will be created on the USB flash drive or SD card.
This file includes the following information.
 - IP address
 - Subnet mask
 - Gateway address
 - Domain name server (DNS)
- Input the IP address shown in the text file into the web browser, and connect it to Streaming Dashboard.

Screen overviews

When connected to Streaming Dashboard, the Encoder Control screen will open.

Tab Area overview

Selection buttons for each page are shown at the top of the screen.

The locations of the buttons depend on the size of the window or tablet display.

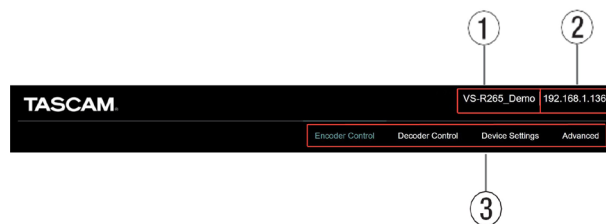

- Current device name**

Shows the currently selected device.

- IP address**

This shows the IP address of the IP address item on the Network page of the Device Settings screen. (see “Network Settings” on page 22)

- Page selection buttons**

Click a page selection button to open that page. The selection button for the open page appears lit.

Button	Meaning
Encoder Control	Use to set and manage encoder functions.
Decoder Control	Used to set and manage decoder functions.
Device Settings	This shows the status of the connected VS-R264/VS-R265 and can be used to make settings for it.
Advanced	Use to restart a connected VS-R264/VS-R265 or update its firmware.

4 - Using Streaming Dashboard

Encoder Control page

All the encoder functions of VS-R264 and VS-R265 units on the current network can be controlled on the Encoder Control screen.

The name of the current device is shown in the drop down menu under Select a Device.

Each entry down the left side shows the status of inputs and encoding functions, the encoder streaming outputs and the Recorder. Click on any entry to view and change the settings.

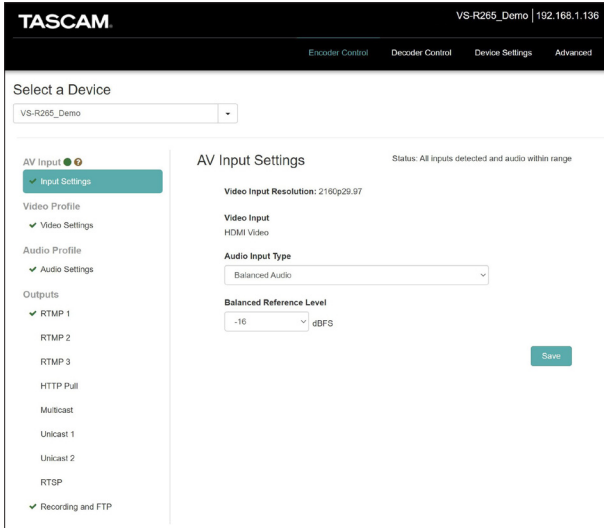

Select a Device

Select the name of the VS-R264/VS-R265 that will have its settings changed.

Click the ▼ button to show a list of all VS-R264/VS-R265 units connected to the network.

AV Input - Analog Overload

This indicates when analog audio input signals reach 3 dB below the maximum input level.

A pop-up message will appear if the mouse pointer is placed over the icon.

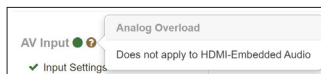

Input Settings

- The status icon beside Input Settings reports on the audio and video input, showing whether a valid video signal is detected for the HDMI Video input and also allowing the Audio input source to be selected.
- A more detailed status description is also found by clicking on Input Settings. Both the status icon and status automatically update in the web UI as changes are detected.

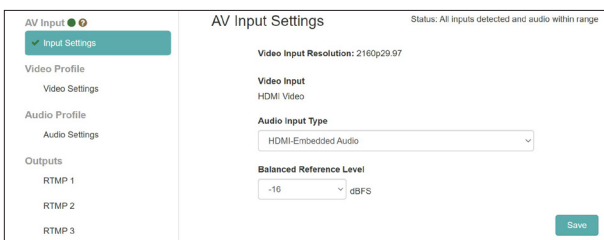

- When ✖ is shown, no valid video signal is currently being detected.

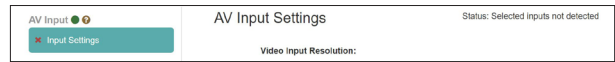

Status Icon	Input Status
✓	All inputs detected and audio within range
✖	Selected inputs not detected
!	Audio input not detected

NOTE

- If using a computer as the HDMI for Video and Audio input, the VS-R264/VS-R265 will be available as an external display named VS-R264 or VS-R265 and an audio output device with the same name.
- If you haven't assigned the VS-R264/VS-R265 audio device to an application, or selected it as the default playback device in your computer and also played some audio through it, it may show as 'Audio input not detected' status in the Input Settings.

Video Input Resolution

This shows the resolution and frame rate when a valid video signal is detected for the HDMI video input.

Video Input Resolution: 2160p29.97

The following resolutions can be input through the HDMI IN connector of the unit.

Progressive video formats:

2160p30/p29.97/p25/p24/p23.98 (VS-R265 only)
 1080p60/p59.94/p50/p30/p29.97/p25/p24/p23.98,
 720p60/p59.94/p50, 576p50, 480p60, 480p59.94

Video Input

It always displays "HDMI Video".

Audio Input Type

Use this to select the appropriate audio input type.

Click this to open an option list.

Option	Meaning
HDMI-Embedded Audio (default)	Select audio embedded in an HDMI signal.
Balanced Audio	Select the analog balanced input.
Unbalanced Audio	Select the analog unbalanced input.

4 - Using Streaming Dashboard

Balanced Reference Level

Set the reference level of the balanced input.
Click this to open a setting value list.

Settings: -16 dBFS (default), -14 dBFS, -9 dBFS

NOTE

- With a Reference Level of -16 dBFS or -14 dBFS the nominal input level is +4 dBU. With a Reference Level of -9 dBFS the nominal input level is +6dBU.
- The Reference level selected for the Balanced Audio Input will also be selected for the Balanced Audio Output.
- After completing settings on this screen, click the Save button to save the settings, otherwise the changes will not be saved.

TIP

A * character will be shown if you have changed any parameter but have not yet clicked on the Save button.

Video Profile - Encoder Video Settings

Select the Video Settings entry to set the encoder functions of the unit related to video.

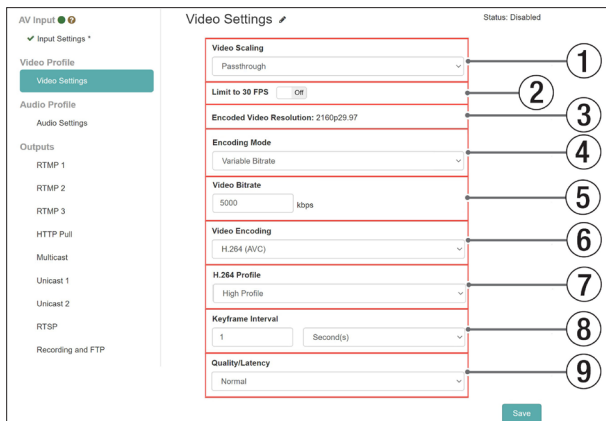

- Video Settings includes a status icon and a description:

Status Icon	Status	Meaning
	Encoding	Video is successfully being encoded.
	Disabled	Video is not being encoded.
	No Input	An output is on but there is no video input.
	Unable to Encode	Video input is detected and an output is on but the video is not being encoded.

1 Video Scaling

This sets the encoded scaling resolution.
Click this to open a setting value list.

Settings: Passthrough, 320x180p, 480x270p, 640x360p, 720x480p, 720x576p, 960x540p, 1280x720p, 1920x1080p, 3840x2160p (VS-R265 only)

NOTE

When "Passthrough" is selected, the input format is encoded.

2 Limit to 30 FPS

When this switch is set to "ON", the frame rate per second will be reduced by half when the input exceeds 30 FPS (default: OFF).

This limits the bit rate needed for higher frame rates.

3 Encoded Video Resolution

This shows the actual format that will be encoded after the scaling and frame rate limit settings have been applied.

4 Encoding Mode

This set the video codec encoding mode.

Click this to open an option list.

Option	Meaning
Constant Bitrate	Fixed bit rate
Variable Bitrate (default)	Variable bit rate

5 Video Bitrate

Set the target bit rate to use in encoding.

To set this, click the ▲ and ▼ buttons that appear when the mouse is over the number or click the number and use a keyboard for input.

Range: 500 - 30000 kbps (default: 10000) in 1 kbps intervals

The following tables show recommended bit rates:

Recommended video bit rates for H.264 (AVC)

Encoded resolution	Optimal bit rate (kbps)	Highest quality bit rate (kbps)
3840x2160	5000	14500
1920x1080	3000	8500
1280x720	2500	7000

Recommended video bit rates for H.265 (HEVC) (VS-R265 only)

Encoded resolution	Optimal bit rate (kbps)	Highest quality bit rate (kbps)
3840x2160	3000	10000
1920x1080	2000	7000
1280x720	1500	5000

NOTE

When the Quality/Latency item is set to High, the same low-quality bit rate is possible.

6 Video Encoding

This sets the video codec type used for the encoding.

Click this to open an option list.

Options: H.264 (AVC) (default),
H.265 (HEVC) (VS-R265 only)

⑦ H.264 Profile/H.265 Profile

Use this to set the profile for the video mode set by the Video Encoding item.

Click this to open an option list.

H.264 Profile options:

High Profile, Main Profile, Baseline Profile

H.265 Profile options(VS-R265 only):

Main Profile

The H.264/H.265 level will be set automatically according to the selected profile.

H.264 level: 3, 3.1, 3.2, 4, 4.1, 5.1

H.265 level: 3.1, 4, 4.1, 5, 5.1

NOTE

The H.264/H.265 level is set based on the settings of the Video Scaling and Video Encoding items.

⑧ Keyframe Interval

- Seconds or frames can be used as the unit of length for the keyframe interval.

Click this to open an option list.

Options: Seconds (default), Frames

- Set the length of the keyframe interval.

To set this, click the ▲ and ▼ buttons that appear when the mouse is over the number or click the number and use a keyboard for input.

Range

Seconds: 0.25 - 16.5 (default: 1) in 0.25 intervals

Frames: 3 - 1000

NOTE

- For recommended values, see the operation manual of the RTMP destination.
- For low bit rate streaming, select a long interval.

⑨ Quality/Latency

Set the B frames per sub GOP for the H.264/H.265 encoding.

Click this to open an option list.

Option	Meaning
High	3 B frames per sub GOP
Normal (default)	2 B frames per sub GOP
Low	1 B frame per sub GOP
Lowest	No B frames

NOTE

After completing settings on this screen, click the Save button to save the settings, otherwise the changes will not be saved.

TIP

A * character will be shown if you have changed any parameter but have not yet clicked on the Save button.

Audio Profile - Encoder Audio Settings

Select the Audio Settings entry to set the encoder functions of the unit related to audio.

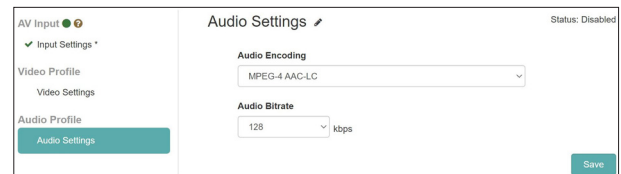

- Audio Settings includes a status icon and a description:

Status Icon	Status	Meaning
	Encoding	Audio is successfully being encoded.
None	Disabled	Audio is not being encoded.
	No Input	An output is on but there is no audio input.
	Unable to Encode	Audio input is detected and an output is on but the audio is not being encoded.

Audio Encoding

- Set the audio encoding type.

Option: MPEG-4 AAC-LC

- Set the audio encoding bit rate.

Options: 64 kbps, 96 kbps, 128 kbps (default), 192 kbps, 256 kbps, 320 kbps, 384 kbps, 512 kbps

NOTE

After completing settings on this screen, click the Save button to save the settings, otherwise the changes will not be saved.

4 - Using Streaming Dashboard

Outputs - Streaming and Recording

Under the Outputs section are all the settings for the different type of streaming protocols and the recording and FTP settings.

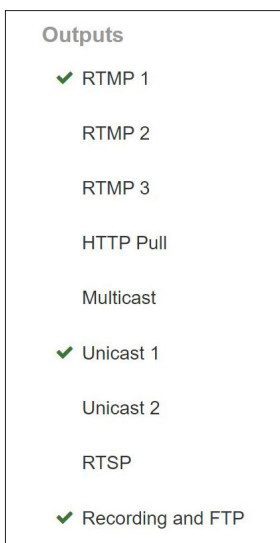

The Status of each of the Outputs is indicated by the icon to the left of each entry. Selecting any of the Outputs will show a further description of the Status and is where the settings for each Output can be entered.

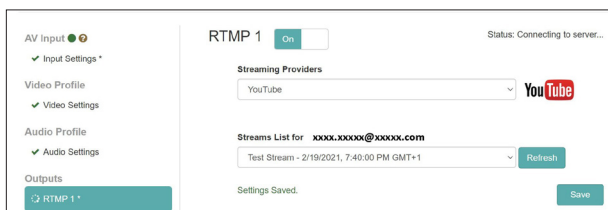

Status Icons

The icon shows whether the encoder is actively streaming or if there is an error.

Status Icon	RTMP 1/2/3	HTTP Pull, Multicast, Unicast 1/2, RTSP	Recording and FTP
None	Stream Off (with no input)	Stream Off (with no input)	No error (Recording off)
✓	Streaming	Streaming	No error (Recording on) Upload in progress Upload successful
✗	Stream Off (with input)	Stream Off (with input)	FTP server unreachable
⌛	Connecting to server...	N/A	
⚠	Error connecting to server	N/A	Video and audio signal lost No storage device Storage device full

Stream Output Settings

Select streaming data destinations and protocols, including RTP/UDP Unicast & Multicast, RTSP, HTTP Pull (HLS) and RTMP.

NOTE

- Multiple streaming destinations can be enabled at the same time. Streaming may be affected as the number of destinations increases, as more bandwidth on the network and via Internet to the online video platform is required for each stream format. So you may need to reduce the number of options and use lower resolutions and bit rates if several streaming protocols are used.
- After changing any of the Stream Output settings, click the Save button to save the settings, otherwise the changes will not be saved.
- A * character will be shown if you have changed any parameter but have not yet clicked on the Save button.

TIP

Check the TASCAM Streaming Guide for more detail about configuring the VS-R264/VS-R265 for different applications.

RTMP 1/2/3 Output Settings

Click on the RTMP 1, RTMP 2 or RTMP 3 Outputs to configure the settings. Each RTMP Output has identical options and all 3 can be used at the same time. RTMP is the most common stream protocol used for online video platforms such as YouTube, Facebook, Twitch and many others.

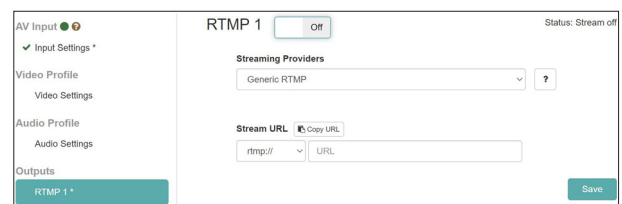

RTMP 1/2/3 On/Off

Click this area to turn output to the RTMP server on/off (default: Off).

Follow these procedures to set the output to an RTMP server.

- Click the "Streaming Providers" menu to open an output destination list. Select the output destination.

Option	Meaning
Generic RTMP (default)	Stream output using a generic RTMP protocol.
Wowza Streaming Engine	Stream output using the Wowza Streaming Engine.
Wowza Cloud	Stream output using Wowza Streaming Cloud.
YouTube	Stream output using YouTube.

NOTE

All 3 x RTMP Outputs are controlled from the front panel STREAM button, allowing the VS-R264/VS-R265 to stream to multiple online platforms simultaneously.

TIP

Some online video platforms provide different server URLs for a primary stream and a backup stream and so the two URLs can be used in separate RTMP Outputs.

4 - Using Streaming Dashboard

- For the Generic RTMP, select the protocol to use.
Options: rtmp:// (default), rtmps://
- Input the RTMP server URL and then a / followed by the Stream key provided by the online video platform.
- e.g. for Facebook the rtmps service is needed:
rtmps://facebook_url/stream_key

NOTE

- Confirm that the Video Encoding item on the Encoder Settings page is set to "H.264 (AVC)" as H.265 (HEVC) is not supported via RTMP.
- The status icon to the right of the URL is updated when connection succeeds or fails.

HTTP Pull (HLS) Output Settings

Click on HTTP Pull for the settings to stream as an HLS server. HLS (HTTP Live Streaming) is Apple's streaming format and can be opened and played by smart phones, tablets, by most web browsers and by software players such as VLC media player. In this case the VS-R264/VS-R265 acts as a server, allowing the connected device(s) to directly pull the video chunks from the internal buffer as required and play them.

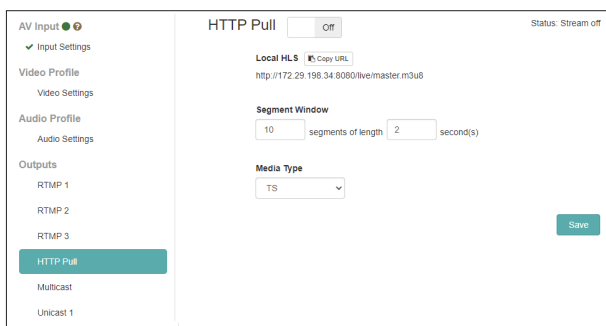

HTTP Pull On/Off

Click this area to turn the HLS server function On/Off. (default: Off).

Local HLS

This shows the HLS server URL (using port 8080 by default).

Segment Window

Set the number of segments (default: 10).
Set the segment length (default: 2 seconds).

NOTE

- Set a short segment length to make the waiting time shorter.
- Set a higher number of segments to enable more stream buffering for the client. This also controls the amount that stream viewers can seek.
- Set a segment length that can be equally divided by the Keyframe Interval set on the Encoder Settings page.

Media Type

This can only be set to TS (Transport Stream).

Multicast Output Settings

Click on Multicast for the settings to stream to a multicast address.

Multicast is a mode for the network switch or router that allows the switch to receive data (in this case as a video stream) and copy this data to a selection or to every device connected to the switch.

Thus Multicast provides a 'one-to-many' streaming function and means that just the bandwidth for 1 stream is required for many clients to receive the stream. By contrast, Unicast streaming requires the stream bandwidth for each connection between an encoder and a decoder.

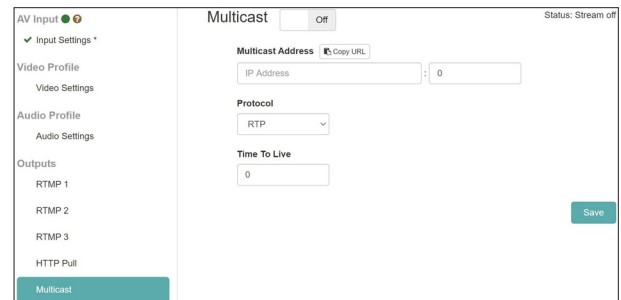

Multicast On/Off

Click this area to turn output to the Multicast address On/Off (default: Off).

Follow these procedures to set the output to a Multicast address.

- Select the protocol.
Select "rtsp://" to increase reliability or "udp://" to decrease waiting time.

NOTE

Each encoder must be set with a unique valid combination of Multicast address and port number.

- Input the Multicast address.
Range: 224.0.0.1 - 239.255.255.255
- Input the port number to set the network port for transmitting the Multicast stream.
Range: 1024 - 49150
- Set the Time to Live (TTL) .
The recommended TTL value is "5".

NOTE

The TTL (Time To Live) setting is determined according to the number of switches and routers that stream is needed to traverse on the network.

4 - Using Streaming Dashboard

Unicast 1/2 Output Settings

Click on Unicast 1/2 for the settings to stream to a unicast address.

Unicast streaming is a point-to-point mode where the Encoder sends a stream to a specific Decoder IP address and on a specific port (you can choose the port number), so making a 'one-to-one' configuration.

VS-R264/VS-R265 units can simultaneously stream to two Unicast addresses, in addition to streaming to a Multicast address.

Settings can be made separately for each Unicast address.

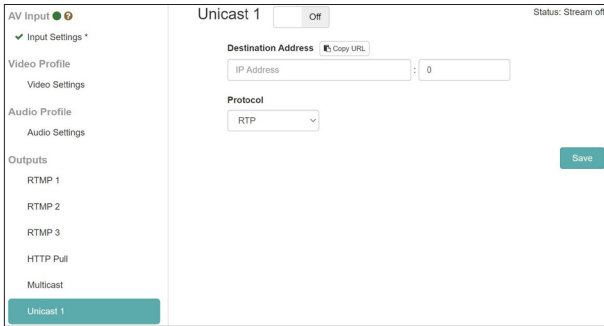

Unicast 1/2 On/Off

Click this area to turn output to the Unicast address On/Off (default: Off).

Follow these procedures to set the output to a Unicast address.

1. Select the protocol.
Select "rtp://" to increase reliability or "udp://" to decrease waiting time.
2. Manually input the IP address of the decoder device.
3. Manually input the port number of the decoder device. Set up the decoder device to receive on the same port number.

RTSP Output Settings

Click on RTSPs for the settings to stream as an RTSP server.

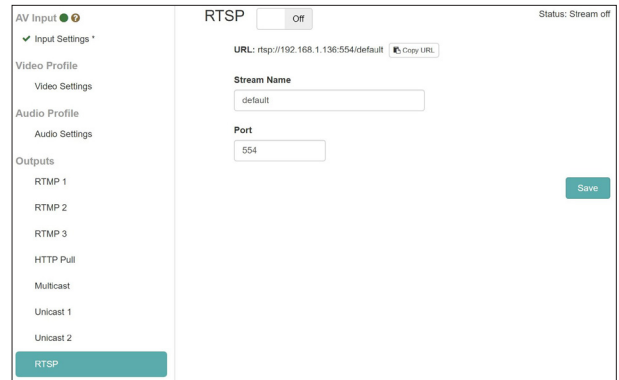

RTSP On/Off

Click this area to turn the RTSP server function On/Off. (default: Off).

URL

This shows the RTSP server URL.

Stream Name

Input the stream name (default: default).

Port

Input the port number (default: 554).

Recording and FTP Settings

Click on the Recording and FTP entry for settings for recording to internal and external storage.

Video can be recorded to 16GB of internal memory, or to external storage with an SD card or USB storage media.

The FTP (File Transfer Protocol) function can upload files automatically to an FTP server after recording completes.

Recording On/Off

Click this area to turn it On, enabling video to be recorded to internal storage or to an external storage device.

ATTENTION

If the input source is not normal and the INPUT indicator is blinking red, recording will not start even when set to On. Recording will start automatically when it becomes normal.

Filename

The default file name used for saving is “VID” when shipped new from the factory. Timestamps will be added to file names when saved to internal and external storage.

Recording File Format

The VS-R264/VS-R265 can record in Transport Stream (.ts) or MP4 (.mp4) file formats.

Both formats are widely supported in players, video editing applications and online platforms.

Transport Stream files are simpler and have the advantage that if recording stops for an unexpected reason (eg. power outage, or if external storage media is disconnected), the .ts file that was being recorded at the time will be usable.

MP4 files have an index that is written as the file is growing and if it wasn't fully updated when the recording stopped, the .mp4 file may be unusable.

Delete Oldest File When Full

This setting frees up space on the selected storage device while recording by automatically deleting the oldest file (using the Timestamp), so that recording can continue when the storage becomes full.

This function can be used to always provide the ability to record to Internal Storage even when the storage is full of old recordings.

Limit Max File Size

The VS-R264/VS-R265 devices can record multiple timestamped files automatically but as the FAT32 file system is used for external SD Cards and USB storage media, the maximum file size should be set at 4GB, as this is the maximum size possible with FAT32, but if Limit Max File Size is off, a new file will be created anyway after 4GB is reached. If using the 16GB Internal Storage, then the maximum file size can be up to the capacity of the storage.

Available Storage Devices

This menu shows the available storage devices and allows one to be selected for recording. Use the drop-down menu to select the storage for recording.

The storage status shows the total of the used capacity and the available capacity, as well as the estimated remaining recording time at the current bit rate.

NOTE

- The FAT32 file system is supported for external storage.
- FAT32 has a maximum file size of 4GB.
- The 16GB Internal storage does not have a file size limitation.
- 1 hour of video at a bit rate of 8,000kbps takes approx. 3.6GB.
- When the maximum file size is reached, a new file will be started automatically.

ATTENTION

- MP4 is a more 'heavy' file writing process than for TS files and may lead to files being corrupted if the storage media is not fast enough.
- TS format can still be readable if there is a power failure, whereas MP4 format may not be readable if the file index has not been completely written.
- Using Internal Storage is much faster for recording than for external media and should be preferred, especially if you are using bitrates above 10,000kbps.
- Make sure that you test your storage media in the exact scenario that you wish to use it, in advance of using it as the only storage for recording a key event.
- There are many reports that claim that storage devices become slower for writing over time, or when they have a high level of data utilisation.
- Try to format your storage media before each recording session if you are using MP4 and bitrates above 10,000kbps.
- If you want to use high bitrates for recording (i.e. over 10,000kbps), then the TS format is the best format to use, as it requires a lower level of performance for the storage media.

Recordings on Storage Device

Click to expand the menu and show a list of recorded files.

Click on any file name to download to your computer via the browser.

NOTE

File downloading can only be performed when recording is stopped.

4 - Using Streaming Dashboard

FTP Upload Settings

Make settings for uploading to an FTP server on this page. Files can be automatically uploaded to an FTP server after recording completes.

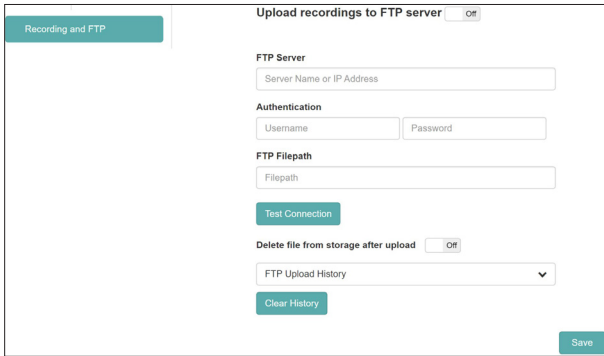

Upload Recordings to FTP Server On/Off

Click this area to turn uploading to the FTP server On/Off (default: Off).

FTP Server

Input the FTP server name or IP address.

Authentication

Input the user name and password for access to the FTP server.

FTP Filepath

Input the FTP file path.

Delete file from storage after upload On/Off

Click this to turn it "On" to erase recorded files from the external storage after FTP uploading completes (default: Off).

NOTE

As FTP (File Transfer Protocol) includes an Acknowledgment when a file has been correctly transferred, deletion of the file from the Internal or External storage can be safely performed.

- Click the **Test Connection** button to check the connection with the FTP server.
- The FTP Upload History shows a confirmed record of files uploaded to the server.
- Click the **Clear History** button to delete the upload history.

NOTE

- FTP uploading is limited to recorded files in the current session. Previously recorded files cannot be uploaded to the FTP server.
- After changing any of the Recording and FTP settings, click the Save button to save the settings, otherwise the changes will not be saved.

TIP

A * character will be shown if you have changed any parameter but have not yet clicked on the Save button.

Decoder Control page

The Decoder Control page can be used to control devices that have decoder functions enabled.

The names of devices are shown with the status of decoder functions and buttons to change settings.

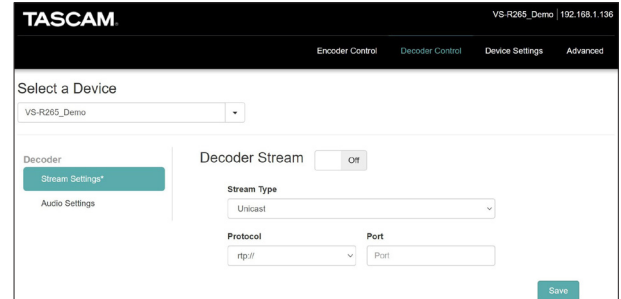

Select a Device

As for the Encoder Control you can use this menu to select the current device and it shows the Device name as set in the Name item on the General page of the Device Settings screen. (see "General Settings" on page 21)

Decoder Stream

Select the Stream Settings entry to view and change Decoder Stream settings.

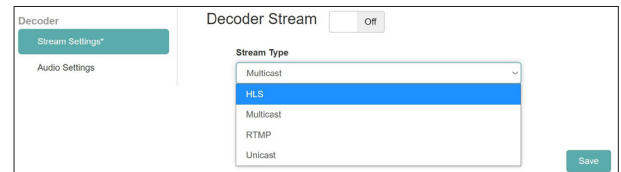

Decoder Stream On/Off

Click this area to turn the Decoder Streaming function On/Off (default: Off).

Stream Type

This drop-down menu allows the decoder stream type to be selected from the following options.

- HLS
- Multicast
- RTMP
- Unicast

NOTE

After changing any of the Decoder settings, click the Save button to save the settings, otherwise the changes will not be saved.

TIP

A * character will be shown if you have changed any parameter but have not yet clicked on the Save button.

4 - Using Streaming Dashboard

HLS Stream Type

Set the encoder device (VS-R264/VS-R 265 or third party encoder) that is generating the HLS video stream to output video data compressed as H.264 (AVC) or H.265 (HEVC). Encode the audio in the stream as AAC.

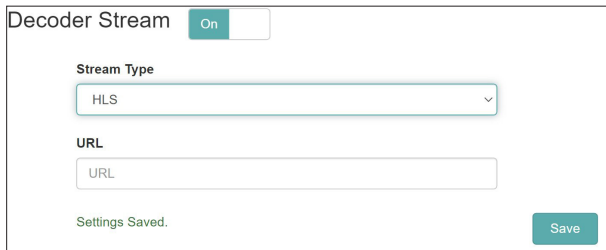

- Stream Type
Select "HLS".
- URL
Input the HLS source URL.

If the VS-R264 /VS-R 265 Encoder of the current device is to be used as the source of the HLS stream (i.e. as a Confidence Monitor), then the URL to be entered will be as shown in the HTTP Pull (HLS) settings for the Encoder, which will use the IP address of the current device.

Multicast Stream Type

Set the encoder device (VS-R264/VS-R 265 or third party encoder) that is generating the Multicast video stream to output video data compressed as H.264 (AVC) or H.265 (HEVC) on an MPEG-2 transport stream using RTP over UDP (rtp://) or Raw UDP (udp://).

Encode the audio in the stream as AAC.

Set the Multicast IP address and port number in the encoder device.

Always use a valid Multicast IP address.

The recommended values are from 224.0.0.1 - 239.255.255.255.

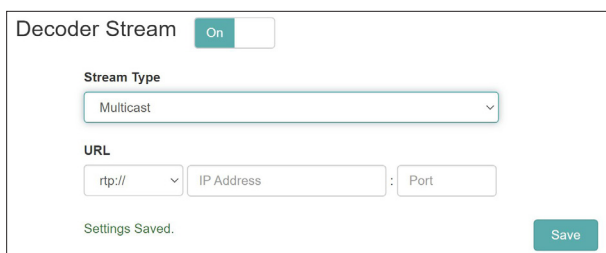

- Stream Type
Select "Multicast".
- Multicast Protocol
Select the protocol suitable for the video source.
- Multicast IP Address
Input the currently set IP address of the desired video source for the third-party encoder device, or if using the current VS-R264/VS-R265, then use the IP address set in the Multicast Output settings of the current device.
- Multicast Port
Input the currently set port number of the video source for the third-party encoder device, or if using the current VS-R264/VS-R265, then use the port number set in the Multicast Output settings of the current device.

RTMP Stream Type

Follow these procedures to set up the target decoder to receive the RTMP playback type from the streaming server.

The RTMP streaming server must be streaming with H.264 video and AAC audio codecs as H.265 (HEVC) is not supported for RTMP.

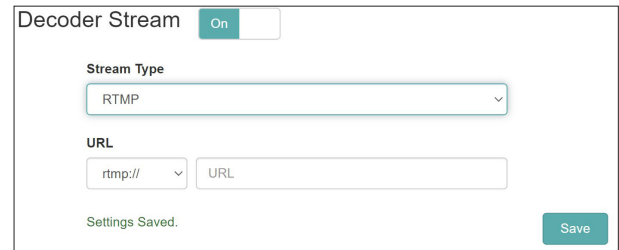

- Stream Type
Select "RTMP".
- URL Prefix
Confirm that "rtmp://" or "rtmps://" is selected as required.
- URL
Input the RTMP source URL.

Unicast Stream Type

Set the encoder device (VS-R264/VS-R 265 or third party encoder) that is generating the Unicast video stream to output video data compressed as H.264 (AVC) or H.265 (HEVC) on an MPEG-2 transport stream using RTP over UDP (rtp://) or Raw UDP (udp://).

Encode the audio in the stream as AAC.

Set the Unicast IP address and port number in the encoder device the same as the for the Decoder, which will always be the IP address of the current VS-R264/VS-R265 device.

Always use a valid Unicast IP address.

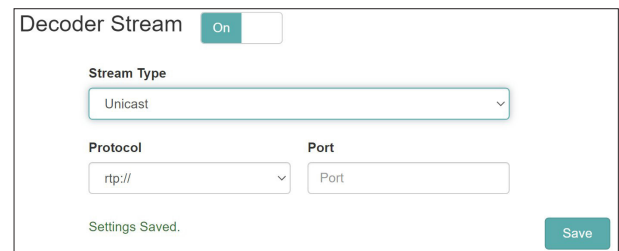

- Stream Type
Select "Unicast".
- Protocol
Select the protocol suitable for the video source.
- Port
Input the currently set port number of the video source for the third-party encoder device, or if using the current VS-R264/VS-R265, then use the port number set in the Unicast Output settings of the current device.

4 - Using Streaming Dashboard

Decoder Audio Settings

Select the Audio Settings entry to view and change Decoder Audio Settings.

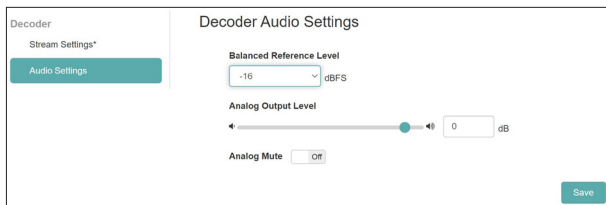

Balanced Reference Level

Use to set the balanced output headroom (difference between the maximum and reference levels).

Settings: -16 dBFS (default), -14 dBFS, -9 dBFS

Click this to open a setting value list.

Analog Output Level

Use to adjust the output level sent to each output connector.

To adjust the value, drag the slider left and right or click the number and enter the value with a keyboard.

Range: -72 dB - +6 dB

Analog Mute

Click this switch to turn it "On" and mute the analog output.

NOTE

- With a Reference Level of -16 dBFS or -14 dBFS the nominal output level is +4 dBu. With a Reference Level of -9 dBFS the nominal output level is +6dBu. The Reference level selected for the Balanced Audio Output will also be selected for the Balanced Audio Input.
- After changing any of the Decoder Audio settings, click the Save button to save the settings, otherwise the changes will not be saved.

TIP

A * character will be shown if you have changed any parameter but have not yet clicked on the Save button.

Confidence Monitor

The VS-R264/VS-R265 HDMI or Audio output are not a 'loop thru' or 'pass-through' connection of the HDMI and Audio inputs, they are the outputs of the VS-R Decoder.

However, it is possible to configure the VS-R264/VS-R265 Encoder to generate a stream that is then received by the Decoder and can be displayed on an HDMI monitor.

For example, if RTMP is used to stream to an online video platform, one of the other Streaming Outputs can be used to send a stream to the Decoder. The streaming protocol that can be used between the Encoder and Decoder is either, Unicast, Multicast or HTTP Pull (HLS).

The HDMI and Audio outputs act as a confidence monitor to check that the encoding is running correctly and the picture/sound is present and the expected quality.

As the same encoding settings are used for the online video platform and the confidence monitor output, the output quality is exactly what the end point user will see, with no artificial pass-through quality (that could be misleading), which is a benefit.

H.264 and H.265 Long-GOP encoding means that the encoding process works over several frames (GOP = Group of Pictures) and of course the audio is encoded as well. The stream then needs to be decoded, which means that there is some latency (delay).

In the Encoder Output settings you can also enable an RTP Unicast stream, using the same IP address as the VS-R264/VS-R265 is allocated to, and using any port number (e.g. 1234).

Then in the Decoder Control settings you can simply enter the same port number (e.g. 1234) to receive the stream that the Encoder is generating. The encode/decode delay (latency) will be 2 - 3 secs for RTP Unicast.

HTTP Pull (HLS) streaming can also be used for Encoder and Decoder. In this case the HTTP Pull (HLS) streaming process is to create a number of video segments that can be read from the HLS server by the Decoder (player).

The default settings are 10 segments of 2 seconds, so there can be 10 secs - 20 secs of delay between encoder input and decoder output. Reducing the number of segments and the duration can reduce latency (e.g. 5 segments of 1 sec).

However a consequence of the increased delay of the HTTP Pull (HLS) streaming mechanism means better streaming of video from encoder to decoder over less-than-ideal networks and via the internet. HLS also provides the ability to stream reliably at higher bit rates, as segments can be pre-buffered and re-read (i.e. Pulled) from the HLS server in case of connection problems.

If the VS-R264/VS-R265 is likely to be allocated a different IP address after power up (the DHCP service for some routers might do this), then it might be needed to enter a fixed IP address for the device or to set the DHCP service to maintain the same allocations.

You can also use a public IP address for the VS-R264/VS-R265 (using Port-Forwarding or Network Address Translation - NAT on your Internet router). Then it is possible to use this public IP address as the destination for the Encoder output, and stream from your Encoder, via the web and back to your Decoder.

Device Settings page

The Device Settings screen shows the status of all VS-R264/VS-R265 units on the current network and can be used to change their settings.

Click the **Save** button to change the settings of the VS-R264/VS-R265 selected with the Select a Device item.

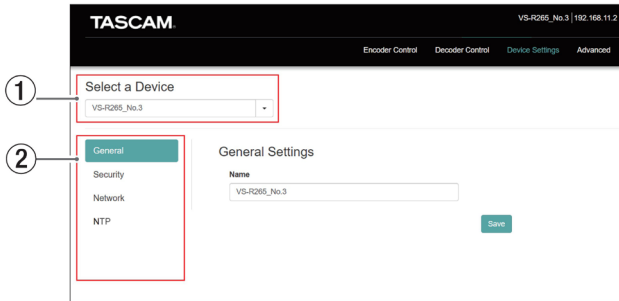

1 Select a Device

Select the name of the VS-R264/VS-R265 that will have its settings changed.

Click the ▼ button to show a list of all VS-R264/VS-R265 units connected to the network.

2 Setting page display

Click the buttons to open the corresponding pages.

General Settings

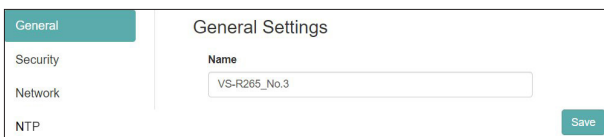

Name

This shows the name of the VS-R264/VS-R265 that is displayed in Streaming Dashboard.

Click this area to make the cursor blink, enabling character input.

The default name when shipped new from the factory is "[model name]+[MAC address]".

Security Settings

Manage the password on the Security page.

This password protects access to the Streaming Dashboard and is for the <admin> Username.

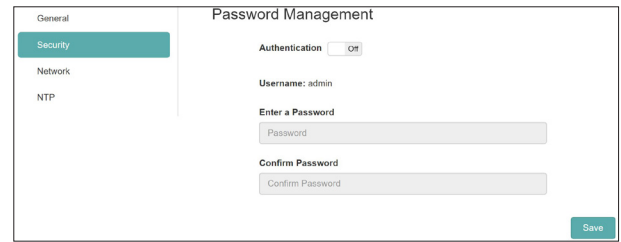

Setting the password

1. Click the Authentication switch to set it to "ON".
2. Click the Enter a Password input field, making the cursor blink.
Input the password.
Uppercase and lowercase letters and numbers can be used.
The maximum number of characters is 8.

NOTE

The password is blank when unit is shipped new.
If no password is set, settings will not be protected.

3. Click the Confirm Password input field, making the cursor blink.
Input the password again.
4. Click the **Save** button to save the password.
5. Click the Authentication switch to disable the password.

NOTE

If the password is forgotten, authentication can be disabled by restoring the unit to its default settings.

See "5 - Hardware Reset Function" on page 24 for how to restore default settings.

4 - Using Streaming Dashboard

Network Settings

Use the Network page to set network functions.

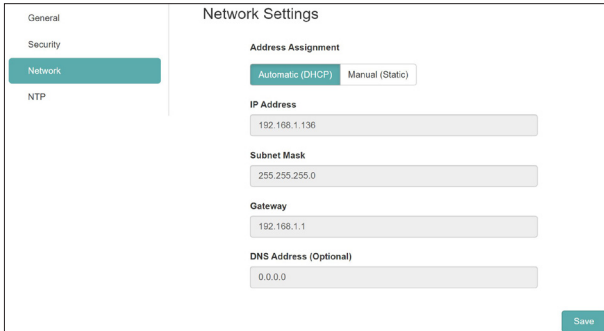

Address Assignment

Set the IP address setting mode.

Click the selected button to change the setting mode.

Option	Meaning
DHCP (default)	The IP Address, Subnet Mask, Gateway and DNS Address items on the Network page will be set automatically. Use this setting if there is a DHCP server on the network.
Static	Set the IP Address, Subnet Mask, Gateway and DNS Address items manually on the Network page.

IP Address

This shows the current IP address set on the device.

Clicking the address area when the Address Assignment item is set to "Static" will cause the cursor to blink and make changing the address possible.

Subnet Mask

This shows the current subnet mask set on the device.

Clicking the address area when the Address Assignment item is set to "Static" will cause the cursor to blink and make changing the address possible.

Gateway

This shows the current gateway set on the device.

Clicking the address area when the Address Assignment item is set to "Static" will cause the cursor to blink and make changing the address possible.

DNS Address (Optional)

This shows the current DNS server address set on the device.

Clicking the address area when the Address Assignment item is set to "Static" will cause the cursor to blink and make changing the address possible.

NOTE

Clicking the **Save** button when the Address Assignment item is set to "Static" will cause the following pop-up message to appear.



NTP Settings

Make NTP server settings on the NTP page.

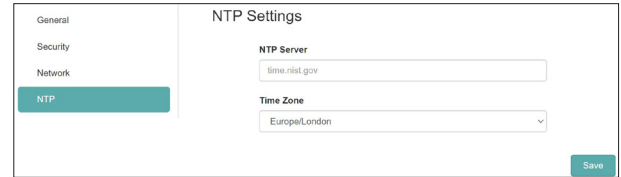

NTP SERVER

Edit the NTP server name.

The default name when shipped new from the factory is "time.nist.gov".

TIME ZONE

Select the time zone appropriate for your use situation.

NOTE

Time zones that use daylight savings will be adjusted automatically.

Advanced page

Use the Advanced page to restart a unit or update its firmware, for example.

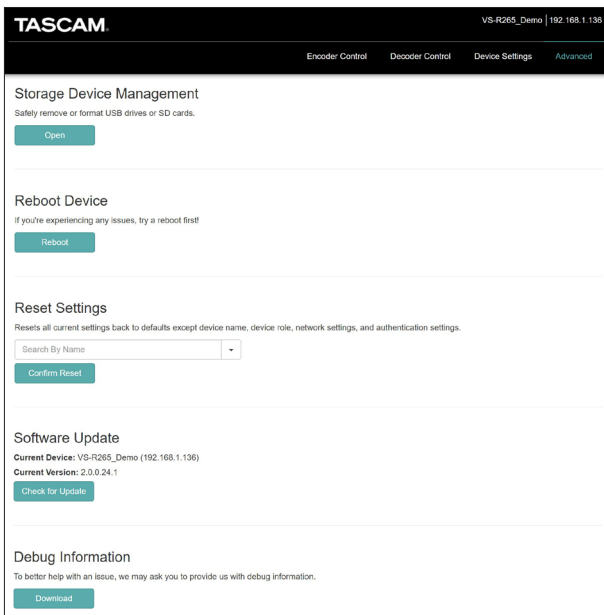

Storage Device Management

Click the **Open** button to open the Storage Device Management screen which allows the safe disconnection and formatting of external storage.

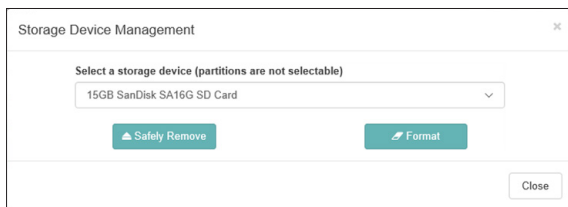

Safe disconnection of external storage

1. Select the external storage to be disconnected.
2. Confirm that the RECORD indicator is unlit, and click the **Safety Remove** button.
A confirmation pop-up message appears.
3. Click the OK button to disconnect.
4. After confirming disconnection, remove the external storage.
Doing this prevents damage to files.

Formatting external storage

1. Select the external storage to be formatted.
2. Confirm that the RECORD indicator is unlit, and click the **Format** button.
A confirmation pop-up message appears.
3. Click the Yes button to start formatting.

Reboot Device

Click the **Reboot** button to restart the VS-R264/VS-R265 set as the current device.

Reset Settings

This resets the settings on the Encoder Control and Decoder Control screens to their factory default values.

1. Click this area to show the names of all VS-R264/VS-R265 units connected to the network.
2. Select the VS-R264/VS-R265 that will be reset to its default settings.
3. Click the **Confirm Reset** button.
The selected VS-R264/VS-R265 will restart and be reset to its default settings.

NOTE

The settings on the Device Settings screen will not be changed.

See "5 - Hardware Reset Function" on page 24 for restoring the settings on the Device Settings screen to their default settings.

Software Update

Use this to update the firmware of a VS-R264/VS-R265 connected to Streaming Dashboard.

This Current Device and Current Version show the name and firmware version of the selected VS-R264/VS-R265.

To update the firmware of the selected VS-R264/VS-R265, click the **Check for Update** button.

NOTE

- If a new firmware version has been released, an update confirmation screen will appear.
- Depending on the size of the update file, connecting an SD card to complete the update might be requested.

Debug Information

Click the **Download** button to download a file with debugging information related to the unit's settings.

This might be helpful for explaining issues when consulting with TASCAM customer support.

5 - Hardware Reset Function

Conduct a hardware reset to reset all the network settings on the Device Settings screen and all the settings shown in Streaming Dashboard, including device names.

1. Turn the device off.
2. Press and hold the STREAM button.
3. Turn the device on while continuing to press the STREAM button.
4. Keep pressing the STREAM button for at least 30 seconds while the power is on.
When resetting completes, all indicators except the POWER indicator will blink five times.
5. After a hardware reset of a device completes, the following values will be set to their defaults.

Default value table

Settings screen	Setting item	Default value		
Encoders screen	Audio Settings screen	Audio Input Type	HDMI with Embedded Audio	
	Encoder Settings screen	Video Input Resolution	Auto-Detected	
		Video Scaling	Passthrough	
		Limit to 30 FPS	OFF	
		Encoding Mode	Variable Bitrate	
		Keyframe Interval	1 second	
		Quality/Latency	Normal	
		Video Encoding		H.264 (AVC)
				10000 kbps
		Profile	High Profile	
	Audio Encoding		MPEG-4 AAC-LC	
			128 kbps	
	RTMP page	RTMP 1/2/3 Outputs	OFF	
	HLS page	HTTP Pull (HLS) Server	OFF	
		Number of Segments	10	
		Segment Length	2 seconds	
	Multicast page	Multicast Output	OFF	
	Unicast pages	Unicast 1 Output	OFF	
		Unicast 2 Output	OFF	
	RTSP page	RTSP Server	OFF	
		Stream Name	default	
		Port	554	
	File recording page	Recording	OFF	
Filename		VID		
FTP Upload page	Upload Recorded Files	OFF		
	Delete file from storage after upload	OFF		
Decoders screen	Audio Settings screen	Balanced Reference Level	-16 dBFS	
		Volume Output Level	0 dB	
		Mute	OFF	
Decoder Stream Settings screen	Source Encoder	Other Encoder		
Device Settings screen	General page	Name	[Model name]+[MAC address]	
	Network page	Address Assignment	DHCP	

Inputs and outputs

Video inputs and outputs

HDMI IN/OUT ports

HDMI IN: HDMI v1.4a (Type A receptacle)

HDMI OUT: HDMI v2.0 (Type A receptacle)

Input resolutions

Progressive Video Formats:

2160p30/p29.97/p25/p24/p23.98 (VS-R265 only),
1080p60/p59.94/p50/p30/p29.97/p25/p24/p23.98,
720p60/p59.94/p50, 576p50, 480p60, 480p59.94

Frame rate limiting

On/Off

Encode scaling resolution

Passthrough, 320x180p, 480x270p, 640x360p, 720x480p,
720x576p, 960x540p, 1280x720p, 1920x1080p, 3840x2160p
(VS-R265 only)

Encoding formats

H.264 (AVC)

H.265 (HEVC) - VS-R265 only

Encoding bit rates

500 kbps - 30 Mbps

Bit rate control

Variable, Constant

Key frame interval

Seconds: 0.25 - 16.5 (default: 1) in 0.25 intervals

Frames: 3 - 1000

Video Streaming

Supported protocols*: RTMP, RTSP, HTTP Pull (HLS), RTP, UDP

Number of simultaneous Output Streams: up to 8

- RTMP: 3
- HTTP Pull (HLS): 1
- RTP/UDP Unicast: 2
- RTP/UDP Multicast: 1
- RTSP: 1

* H.265 format streaming is not supported in the RTMP protocol, but is available for all others.

Video Recording & FTP

Supported file formats: Transport Stream (.ts), MP4 (.mp4).

Recording to 16GB Internal Storage, SD Card or USB Drive.

Video format and bit rate for Recording: Same resolution as configured in Encoder for Video Streaming.

Video Recording and Streaming are performed at the same time.

Manual download of recorded files to computer via Web Browser.

Automatic Upload of recorded files to FTP server.

Audio inputs and outputs

ANALOG IN connectors (balanced)

Connectors: Euroblock 3.81 mm pitch

Nominal input levels:

+4 dBu (1.23 Vrms, when Ref.Level set to other than -9 dBFS)

+6 dBu (1.55 Vrms, when Ref. Level set to -9 dBFS)

Maximum input level (switchable):

+15 dBu (4.36 Vrms, Ref. Level: -9 dBFS)

+18 dBu (6.16 Vrms, Ref. Level: -14 dBFS)

+20 dBu (7.75 Vrms, Ref. Level: -16 dBFS)

Input impedance: 10 kΩ or higher

ANALOG IN connectors (unbalanced)

Connector: 3.5mm (1/8") stereo mini jack

Input impedance: 10 kΩ

Minimum input level: -10 dBV (0.316 Vrms)

Maximum input level: +6 dBV (2.0 Vrms)

ANALOG OUT connectors (balanced)

Connectors: Euroblock 3.81 mm pitch

Nominal output levels:

+4 dBu (1.23 Vrms, when Ref.Level set to other than -9dBFS)

+6 dBu (1.55 Vrms, when Ref. Level set to -9 dBFS)

Maximum output level (switchable):

+15 dBu (4.36 Vrms, Ref.Level: -9 dBFS)

+18 dBu (6.16 Vrms, Ref.Level: -14 dBFS)

+20 dBu (7.75 Vrms, Ref.Level: -16 dBFS)

Output impedance: 200 Ω or lower

ANALOG OUT connectors (unbalanced)

Connector: 3.5mm (1/8") stereo mini jack

Output impedance: 200 Ω

Minimum output level: -10 dBV (0.316 Vrms)

Maximum output level: +6 dBV (2.0 Vrms)

- 0 dBu=0.775 Vrms

Control input/output

Ethernet/PoE+ connector

Connector: RJ-45

Transmission protocol: TCP/IP, UDP, HTTP

Gigabit Ethernet standard: 100/1000BASE-T (IEEE 802.3ab)

Cables: category 5e or faster STP cables

USB port

Connector: USB A-type 4-pin

Protocol: USB 3.0

6 - Specifications

Audio performance

Built-in AD converter performance

Distortion (THD+N)

0.002%

S/N ratio

102dB

Built-in DA converter performance

Distortion (THD+N)

0.00035%

S/N ratio

130dB

Analog input - digital (HDMI) output performance (AAC encoding/decoding 512 kbps)

Frequency response

20 Hz - 16.5 kHz: ± 0.5 dB (JEITA)

Distortion (THD+N)

0.008% or less (Full scale -0.5 dB, JEITA)

S/N ratio

94 dB or higher (JEITA)

Dynamic range

95 dB or higher (JEITA)

Channel crosstalk

90 dB or higher (JEITA)

Digital (HDMI) - analog output performance (AAC encoding/decoding 512 kbps)

Frequency response

20 Hz - 16.5 kHz: ± 0.5 dB (JEITA)

Distortion (THD+N)

0.007% or less (Full scale -0.5 dB, JEITA)

S/N ratio

Balanced output: 113 dB or higher (JEITA)

Unbalanced output: 109 dB or higher (JEITA)

Dynamic range

96 dB or higher (JEITA)

Channel crosstalk

100 dB or higher (JEITA)

Note: JEITA indicates compliance with JEITA CP-2150

Other

Power

PoE Plus Class 4

TASCAM PS-P1220E AC adapter (sold separately)

Power consumption

12.2W

Dimensions

214 × 44.5 × 136.1mm (W x H x D, including protrusions)

Weight

850g

Operating temperature range

0 - 40°C (32 - 104°C)

Dimensional drawings

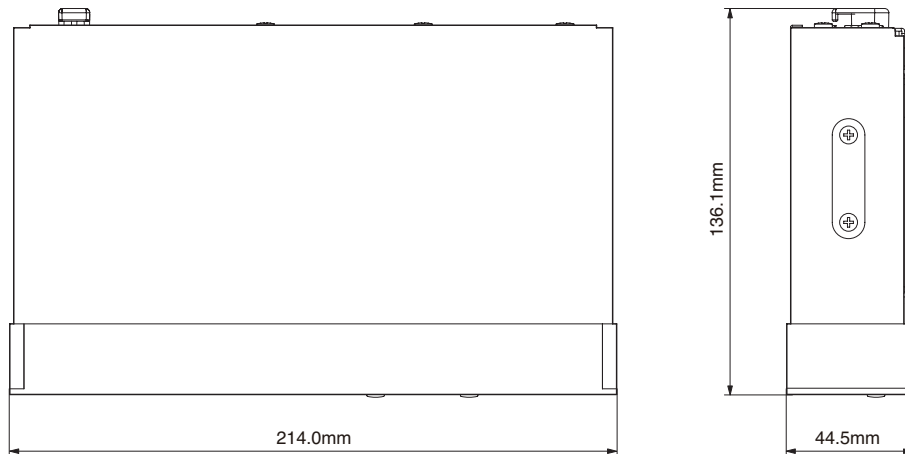

Main unit

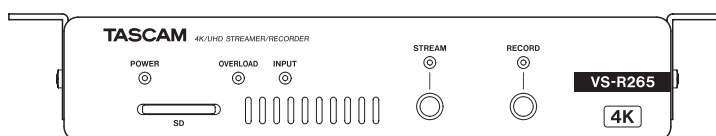
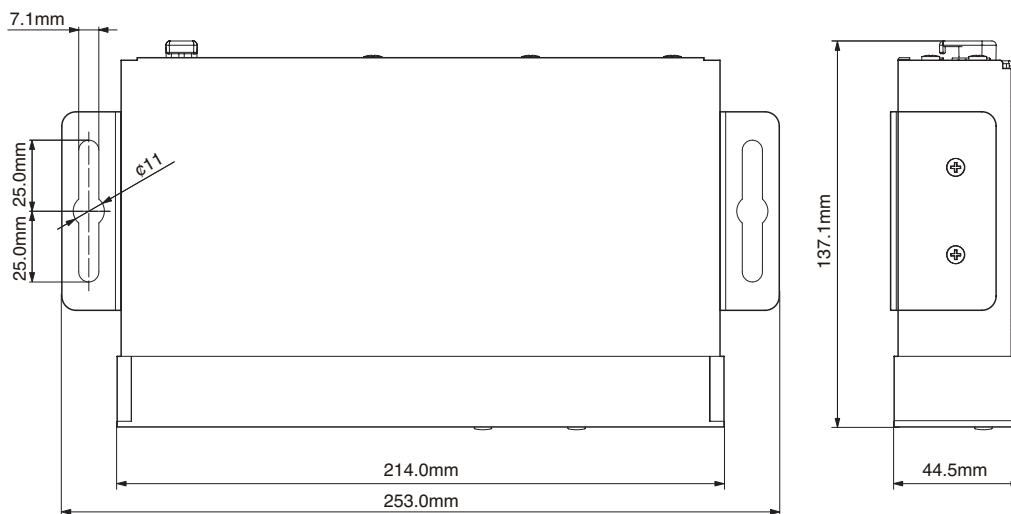

Main unit with brackets installed

- Illustrations in this manual might differ in part from the actual product.
- Specifications and external appearance might be changed without notification to improve the product.

TASCAM

TEAC CORPORATION
Phone: +81-42-356-9143
1-47 Ochiai, Tama-shi, Tokyo 206-8530 Japan

<https://tascam.jp/jp/>

TEAC AMERICA, INC.
Phone: +1-323-726-0303
10410 Pioneer Blvd. Suite #1 Santa Fe Springs, California 90670, U.S.A.

<https://tascam.com/us/>

TEAC UK Ltd.
Phone: +44-1923-797205
Luminous House, 300 South Row, Milton Keynes, Buckinghamshire, MK9 2FR, UK

<https://www.tascam.eu/en/>

TEAC EUROPE GmbH
Phone: +49-611-71580
Bahnstrasse 12, 65205 Wiesbaden-Erbenheim, Germany

<https://www.tascam.eu/de/>

TEAC SALES & TRADING(SHENZHEN) CO., LTD
Phone: +86-755-88311561~2
Room 817, Xinian Center A, Tairan Nine Road West, Shennan Road, Futian District, Shenzhen, Guangdong Province 518040, China

<https://tascam.cn/cn>