

# TASCAM

D01164320B

# CD-9010CF

## CD/Solid State Player

### OWNER'S MANUAL

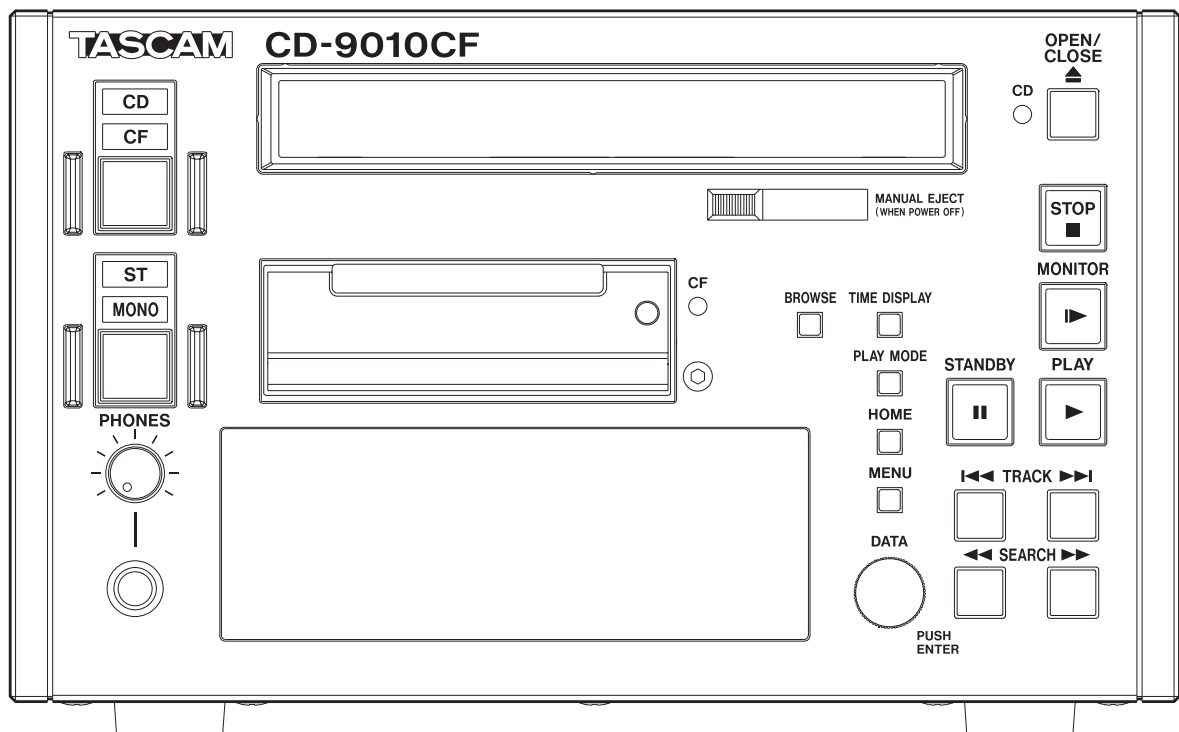

# Important Safety Information



**CAUTION**  
RISK OF ELECTRIC SHOCK  
DO NOT OPEN



**CAUTION:** TO REDUCE THE RISK OF ELECTRIC SHOCK, DO NOT REMOVE COVER (OR BACK). NO USER-SERVICEABLE PARTS INSIDE. REFER SERVICING TO QUALIFIED SERVICE PERSONNEL.



The lightning flash with arrowhead symbol, within equilateral triangle, is intended to alert the user to the presence of uninsulated “dangerous voltage” within the product’s enclosure that may be of sufficient magnitude to constitute a risk of electric shock to persons.



The exclamation point within an equilateral triangle is intended to alert the user to the presence of important operating and maintenance (servicing) instructions in the literature accompanying the appliance.

**WARNING: TO PREVENT FIRE OR SHOCK HAZARD, DO NOT EXPOSE THIS APPLIANCE TO RAIN OR MOISTURE.**

- 1 Read these instructions.
- 2 Keep these instructions.
- 3 Heed all warnings.
- 4 Follow all instructions.
- 5 Do not use this apparatus near water.
- 6 Clean only with dry cloth.
- 7 Do not block any ventilation openings. Install in accordance with the manufacturer’s instructions.
- 8 Do not install near any heat sources such as radiators, heat registers, stoves, or other apparatus (including amplifiers) that produce heat.
- 9 Do not defeat the safety purpose of the polarized or grounding-type plug. A polarized plug has two blades with one wider than the other. A grounding type plug has two blades and a third grounding prong. The wide blade or the third prong are provided for your safety. If the provided plug does not fit into your outlet, consult an electrician for replacement of the obsolete outlet.
- 10 Protect the power cord from being walked on or pinched particularly at plugs, convenience receptacles, and the point where they exit from the apparatus.
- 11 Only use attachments/accessories specified by the manufacturer.

- 12 Use only with the cart, stand, tripod, bracket, or table specified by the manufacturer, or sold with the apparatus. When a cart is used, use caution when moving the cart/apparatus combination to avoid injury from tip-over.



- 13 Unplug this apparatus during lightning storms or when unused for long periods of time.
- 14 Refer all servicing to qualified service personnel. Servicing is required when the apparatus has been damaged in any way, such as power-supply cord or plug is damaged, liquid has been spilled or objects have fallen into the apparatus, the apparatus has been exposed to rain or moisture, does not operate normally, or has been dropped.
  - The apparatus draws nominal non-operating power from the AC outlet with its POWER or STANDBY/ON switch not in the ON position.
  - The mains plug is used as the disconnect device, the disconnect device shall remain readily operable.
  - Caution should be taken when using earphones or headphones with the product because excessive sound pressure (volume) from earphones or headphones can cause hearing loss.

## CAUTION

- Do not expose this apparatus to drips or splashes.
- Do not place any objects filled with liquids, such as vases, on the apparatus.
- Do not install this apparatus in a confined space such as a book case or similar unit.
- The apparatus should be located close enough to the AC outlet so that you can easily grasp the power cord plug at any time.
- If the product uses batteries (including a battery pack or installed batteries), they should not be exposed to sunshine, fire or excessive heat.
- CAUTION for products that use replaceable lithium batteries: there is danger of explosion if a battery is replaced with an incorrect type of battery. Replace only with the same or equivalent type.

## WARNING

Products with Class I construction are equipped with a power supply cord that has a grounding plug. The cord of such a product must be plugged into an AC outlet that has a protective grounding connection.

In North America use only on 120V supply.

## ■ For U.S.A.

### TO THE USER

This equipment has been tested and found to comply with the limits for a Class A digital device, pursuant to Part 15 of the FCC Rules. These limits are designed to provide reasonable protection against harmful interference when the equipment is operated in a commercial environment. This equipment generates, uses, and can radiate radio frequency energy and, if not installed and used in accordance with the instruction manual, may cause harmful interference to radio communications.

Operation of this equipment in a residential area is likely to cause harmful interference in which case the user will be required to correct the interference at his own expense.

### CAUTION

Changes or modifications to this equipment not expressly approved by TEAC CORPORATION for compliance could void the user's authority to operate this equipment.

## ■ For European Customers

### CE Marking Information

- a) Applicable electromagnetic environment: E4
- b) Peak inrush current: 14 A

### Disposal of electrical and electronic equipment

- (a) All electrical and electronic equipment should be disposed of separately from the municipal waste stream via collection facilities designated by the government or local authorities.
- (b) By disposing of electrical and electronic equipment correctly, you will help save valuable resources and prevent any potential negative effects on human health and the environment.
- (c) Improper disposal of waste electrical and electronic equipment can have serious effects on the environment and human health because of the presence of hazardous substances in the equipment.
- (d) The Waste Electrical and Electronic Equipment (WEEE) symbol, which shows a wheeled bin that has been crossed out, indicates that electrical and electronic equipment must be collected and disposed of separately from household waste.



- (e) Return and collection systems are available to end users. For more detailed information about the disposal of old electrical and electronic equipment, please contact your city office, waste disposal service or the shop where you purchased the equipment.

### Disposal of batteries and/or accumulators

- (a) Waste batteries and/or accumulators should be disposed of separately from the municipal waste stream via collection facilities designated by the government or local authorities.
- (b) By disposing of waste batteries and/or accumulators correctly, you will help save valuable resources and prevent any potential negative effects on human health and the environment.
- (c) Improper disposal of waste batteries and/or accumulators can have serious effects on the environment and human health because of the presence of hazardous substances in them.
- (d) The WEEE symbol, which shows a wheeled bin that has been crossed out, indicates that batteries and/or accumulators must be collected and disposed of separately from household waste.



Pb, Hg, Cd

If a battery or accumulator contains more than the specified values of lead (Pb), mercury (Hg), and/or cadmium (Cd) as defined in the Battery Directive (2006/66/EC), then the chemical symbols for those elements will be indicated beneath the WEEE symbol.

- (e) Return and collection systems are available to end users. For more detailed information about the disposal of waste batteries and/or accumulators, please contact your city office, waste disposal service or the shop where you purchased them.

### WARNING

This is a Class A product. In a domestic environment, this product may cause radio interference in which case the user may be required to take adequate measures.

### For Canada

THIS CLASS A DIGITAL APPARATUS COMPLIES WITH CANADIAN ICES-003.CET

APPAREIL NUMERIQUE DE LA CLASSE B EST CONFORME A LA NORME NMB-003 DU CANADA.

# Safety precautions

## ■ CAUTIONS ABOUT LASER RADIATION

This product has been designed and manufactured according to FDA regulations "title 21, CFR, chapter 1, subchapter J, based on the Radiation Control for Health and Safety Act of 1968," and is classified as a class 1 laser product. There is no hazardous invisible laser radiation during operation because invisible laser radiation emitted inside of this product is completely confined in the protective housings.

The label required in this regulation is shown at ①.

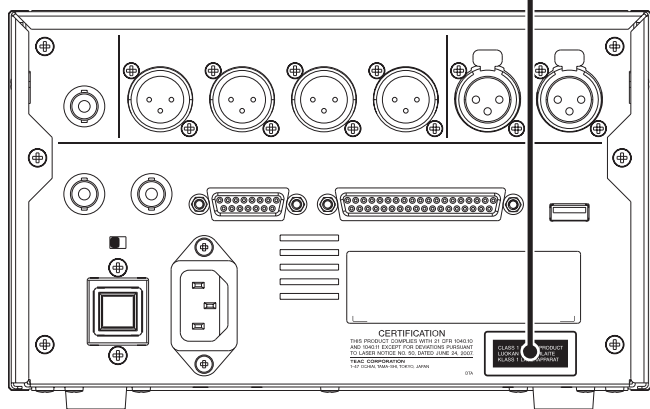
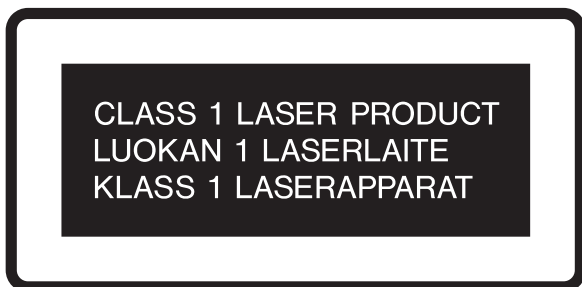

This appliance has a serial number located on the rear panel. Please record the model number and serial number and retain them for your records.

**Model number**

---

**Serial number**

---

## CAUTIONS

- DO NOT REMOVE THE PROTECTIVE HOUSING USING A SCREWDRIVER.
- USE OF CONTROLS OR ADJUSTMENTS OR PERFORMANCE OF PROCEDURES OTHER THAN THOSE SPECIFIED HEREIN MAY RESULT IN HAZARDOUS RADIATION EXPOSURE.
- IF THIS PRODUCT DEVELOPS TROUBLE, CONTACT YOUR NEAREST QUALIFIED SERVICE PERSONNEL, AND DO NOT USE THE PRODUCT IN ITS DAMAGED STATE.

### Optical pickup

Type: HOF-1501XB  
Manufacturer: Hitachi Media Electronics  
Laser output: Less than 0.5 mW on the objective lens  
Wavelength: 785 nm  $\pm$ 22 nm  
Standard: IEC60825-1 : 2007

<b>1 – Introduction</b> .....	7	Setting the playback point .....	23
Features .....	7	Selecting tracks.....	23
Included items .....	7	Operation after selection of a track.....	23
Conventions used in this manual .....	7	Searching within tracks.....	23
Intellectual property rights .....	8	Auto cue function .....	23
Precautions for placement and use.....	8	Auto ready function.....	24
Connecting the power .....	8	Incremental playback function.....	24
Beware of condensation.....	8	ONLINE BACK CUE function .....	25
Cleaning the unit.....	8	PLAY KEY FUNCTION setting .....	25
About CF cards.....	8	MONITOR PLAY STBY function.....	26
Precautions for use .....	8	ONLINE PLAY STBY function .....	26
Card formatting .....	8	Repeat playback.....	26
About discs.....	9	Ordinary repeat playback .....	26
Handling of compact discs .....	9	EOM functions.....	27
<b>2 – Names and Functions of Parts</b> .....	10	Setting EOM tally output trigger.....	27
Front panel .....	10	How to use the EOM .....	27
Rear panel.....	12	Checking the ends of tracks.....	27
Home Screen .....	13	Setting the amount of time checked.....	27
Menu structure .....	14	How to use the end check function .....	27
Menu operation basics .....	16	Pitch control playback.....	28
Menu operation procedures.....	16	Turning pitch control playback ON/OFF .....	28
<b>3 – Preparations</b> .....	17	Setting the pitch control value .....	28
Turning the power ON and OFF.....	17	PITCH/TIME FIT function.....	28
Turning the power OFF .....	17	<b>5 – Program and cue playback</b> .....	29
Setting the date and time .....	17	Program playback.....	29
Adjusting the display.....	18	Program menu operation .....	29
Adjusting display contrast .....	18	Adding tracks to a program .....	29
Adjusting display and indicator brightness.....	18	Clearing a program.....	30
Inserting and ejecting CF cards .....	19	Removing tracks from a program .....	30
Inserting CF cards.....	19	Moving tracks within a program .....	30
Ejecting CF cards .....	19	Importing programs .....	31
Using the security screw.....	19	Exporting programs.....	31
Connecting headphones .....	20	Cue point playback.....	31
Setting the panel lock function .....	20	Using the cue menu .....	31
<b>4 – Playback</b> .....	21	Adding cue points .....	31
Monitoring and online playback.....	21	Clearing the cue list.....	32
Monitoring playback.....	21	Clearing a cue point .....	32
Online playback.....	21	Editing cue point names.....	33
Setting the playback mode .....	21	Editing text .....	33
Playing a track once from the beginning .....	22	Importing cue lists.....	34
Playing a track from the middle.....	22	Exporting cue lists .....	34
Automatic cue point memory (last cue) .....	22	Automatic cue point loading options .....	34

# Contents

<b>6 – Working with files and folders</b> .....	35	<b>9 – Operation using a computer keyboard</b> ...	47
Opening the BROWSE screen.....	35	Setting the keyboard language.....	47
Navigating the BROWSE screen.....	35	Using a keyboard to input text.....	47
Icons on the BROWSE screen.....	35	<b>10 – Using the remote connectors</b> .....	48
File operations.....	35	Using the serial connector.....	48
Folder operations.....	36	Fader use setting.....	48
Editing folder names (CF cards).....	36	Fader start function setting.....	48
Editing file names (CF cards).....	37	Fader stop function setting.....	48
Deleting folders and files (CF cards).....	37	Fader stop action setting.....	49
Creating new folders (CF cards).....	38	Setting the fader scale used.....	49
File and folders on CF cards and data CDs.....	38	Transmission speed setting.....	49
<b>7 – Managing CF cards</b> .....	39	Using the parallel connector.....	50
Formatting CF cards quickly.....	39	Parallel port 3-pin/13-pin setting.....	50
Formatting CF cards (full format).....	39	<b>11 – Message list</b> .....	51
Ripping CD tracks to CF cards.....	40	Error messages.....	51
<b>8 – Other settings and information display</b> .....	41	Warning messages.....	51
Setting the digital reference level.....	41	Operation messages.....	51
Setting the analog reference level.....	41	<b>12 – Troubleshooting</b> .....	52
Adjusting R/L analog reference levels.....	42	<b>13 – Specifications</b> .....	53
Setting the online function.....	42	Media and file formats.....	53
Setting the master word clock.....	43	Inputs and outputs.....	53
Mono mix setting.....	43	Analog audio inputs and outputs.....	53
Master clock and digital output combinations.....	43	Digital audio output.....	53
Setting the level meter display type.....	44	Control inputs and outputs.....	53
Fail safe function setting.....	44	Audio performance.....	53
Monitoring point setting.....	45	Backup memory.....	54
Muting monitoring when online.....	45	General.....	54
Importing menu settings.....	45	Dimensional drawings.....	54
Exporting menu settings.....	45		
Restoring the factory settings.....	46		
Viewing media information.....	46		
Viewing system information.....	46		

## 产品有毒有害物质或元素的名称及含量

机种: CD-9010CF		有毒有害物质或元素					
	品名	铅 (Pb)	汞 (Hg)	镉 (Cd)	六价铬 (Cr6+)	多溴联苯 (PBB)	多溴二苯醚 (PBDE)
1	CHASSIS 部份	○	○	○	○	○	○
2	PCB Assy 部份	×	○	○	○	○	○
3	CD DRIVE 部份	○	○	○	○	○	○
4	线材部份	○	○	○	○	○	○
5	附属品部份	○	○	○	○	○	○
6	LABEL 部份	○	○	○	○	○	○
7	包装部份	○	○	○	○	○	○

○: 表示该有毒有害物质在该部件所有均质材料中的含量均在 SJ/T11363-2006 标准规定的限量要求以下。

×: 表示该有毒有害物质至少在该部件的某一均质材料中的含量超出 SJ/T11363-2006 标准规定的限量要求。

(针对现在代替技术困难的电子部品及合金中的铅)

# 1 – Introduction

Thank you very much for purchasing a TASCAM CD-9010CF CD/Solid State Player.

Please read this manual thoroughly before using the unit so that you understand correct operating procedures and can use its functions fully. We hope that you enjoy using this unit for many years.

Please keep this manual so that you can refer to it at any time. A digital copy of this manual can also be downloaded from the TEAC Global Site (<http://teac-global.com/>).

---

## Features

---

This professional CD player is designed for a variety of uses, including broadcasting, postproduction and installation applications. Here are some of its features.

- In addition to commercially-available audio CDs, CD-DA format audio CDs and CD-R discs with WAV format files (except unfinalized data CDs) can be played back
- 44.1/48kHz linear PCM audio (WAV format) files on CF cards can be played back (Maximum file size is 2GB)
- Analog inputs: **MIX INPUTS** stereo pair (signal can mixed with the CD/CF playback signal or passed through as is to the **LINE OUTPUTS**)
- Analog outputs: **LINE OUTPUTS** stereo pair, **MONITOR OUTPUTS** stereo pair and stereo **PHONES** monitoring output
- Digital output: 1 stereo output with sample rate conversion
- Playback signals of the two playback modes—online playback for live/on-air use and monitoring playback for confirmation/rehearsal use—can be output from different connectors
- Auto cue function enables standby at the point when audio begins in a track
- Auto ready function enables automatic standby at the beginning of the next track after one track completes playback
- **JOG** dial enables searching one frame at a time
- Searching by index is possible
- Fail safe function prevents misoperation during critical playback situations
- Synchronization with external word clock (44.1 or 48 kHz) is possible and the CD playback signal can be output digitally with a 48kHz sampling frequency when synchronized with 48kHz external clock
- $\pm 12.5\%$  pitch control function
- Connect a TASCAM RC-9010/RC-9010S remote control (sold separately) to enhance operation and increase functionality
- End check function allows playback of the ends of tracks
- Up to 9 cue points can be remembered for each disc
- Manual eject mechanism allows CDs to be removed even when the power is off

---

## Included items

---

This product includes the following items.

Take care when opening the package to avoid damaging the items. Keep the packing materials for transportation in the future.

Please contact the store where you purchased this unit if any of these items are missing or have been damaged during transportation.

- Main unit ..... 1
- Power cord ..... 1
- Security device ..... 1
- Warranty card ..... 1
- Owner's Manual (this manual) ..... 1

---

## Conventions used in this manual

---

In this manual, we use the following conventions:

- When instructed to select an item, use the controls so that item appears to be light letters on a dark background.
- Buttons, connectors and other parts of the unit and external devices are indicated like this: **STOP**
- Messages on the unit's display are shown like this: MENU
- CD-DA format discs are sometimes called "audio CDs"
- A CD with WAV files is sometimes called a "data CD"
- "CompactFlash card" is abbreviated as "CF card"
- The device that is currently selected (CD or CF card) is called the "current device".
- Additional information is provided as necessary as tips, notes and cautions.

### TIP

*These are tips about how to use the unit.*

### NOTE

*These provide additional explanations and describe special cases.*

### CAUTION

*Failure to follow these instructions could result in injury, damage to equipment or lost recording data, for example.*

# 1 – Introduction

---

## Intellectual property rights

---

- TASCAM is a trademark of TEAC Corporation, registered in the U.S. and other countries.
- CompactFlash is a registered trademark of SanDisk Corporation in the USA and other countries.
- Other company names, product names and logos in this document are the trademarks or registered trademarks of their respective owners.

Any data, including, but not limited to information, described herein are intended only as illustrations of such data and/or information and not as the specifications for such data and/or information. TEAC Corporation disclaims any warranty that any use of such data and/or information shall be free from infringement of any third party's intellectual property rights or other proprietary rights, and further, assumes no liability of whatsoever nature in the event of any such infringement, or arising from or connected with or related to the use of such data and/or information.

This product is designed to help you record and reproduce sound works to which you own the copyright, or where you have obtained permission from the copyright holder or the rightful licensor. Unless you own the copyright, or have obtained the appropriate permission from the copyright holder or the rightful licensor, your unauthorized recording, reproduction or distribution thereof may result in severe criminal penalties under copyright laws and international copyright treaties. If you are uncertain about your rights, contact your legal advisor. Under no circumstances will TEAC Corporation be responsible for the consequences of any illegal copying performed using the recorder.

---

## Precautions for placement and use

---

- The operating temperature should be between 5°C and 35°C (41°F and 95°F).
- Do not install in the following types of places. Doing so could degrade the sound quality and/or cause malfunctions.
  - Places with significant vibrations or that are otherwise unstable
  - Near windows or other places exposed to direct sunlight
  - Near heaters or other extremely hot places
  - Extremely cold places
  - Places with bad ventilation or high humidity
  - Very dusty locations
- This unit can be installed at an angle of  $\pm 5^\circ$ .
- In order to assure good heat dissipation, do not place any object on top of the unit.
- Do not install this unit on top of any heat-generating electrical device such as a power amplifier.

---

## Connecting the power

---

- Insert the included power cord into the **AC IN** connector completely.
- Hold the power cord by the plug when connecting or disconnecting it.

---

## Beware of condensation

---

If the unit is moved from a cold to a warm place, or used immediately after a cold room has been heated or otherwise exposed to a sudden temperature change, condensation could occur. Should this happen, leave the unit for one or two hours before turning the unit on.

---

## Cleaning the unit

---

To clean the unit, wipe it gently with a soft dry cloth. Do not wipe with chemical cleaning cloths, paint thinner, ethyl alcohol or other chemical agents to clean the unit as they could damage the surface.

---

## About CF cards

---

A list of CF cards that have been confirmed for use with this unit can be found on our web site. Please access to a product page of this product from the TEAC Global Site (<http://teac-global.com>) to find the list or contact the TASCAM customer support service.

---

## Precautions for use

---

CF cards are delicate media. In order to avoid damaging a memory/card or the memory/card slot, please take the following precautions when handling them.

- Do not leave them in extremely hot or cold places.
- Do not leave them in extremely humid places.
- Do not let them get wet.
- Do not put things on top of them or twist them.
- Do not hit them.
- Do not insert or remove them during recording, playback, data transfer or other operations that access the card.
- Do not carry them with terminals exposed. Use the protective cover.

---

## Card formatting

---

CF cards that have been formatted by this unit are optimized for performance during recording. Using a card that has been formatted by a computer, for example, could result in errors during recording. We recommend that whenever possible you use CF cards after they have been formatted by this unit.



---

## About discs

---

In addition to commercially-available music CDs, this unit can play CD-R discs that have been recorded in audio CD (CD-DA) format, as well as CD-R discs that have WAV audio files recorded on them. It can also playback 8cm discs.

---

## Handling of compact discs

- Always load compact discs with their labels facing upward.
- To remove a disc from its case, press down on the center of the disc holder, then lift the disc out, holding it carefully by the edges.
- Do not touch the signal side (the unlabeled side). Fingerprints, oils and other substances can cause errors during playback.
- To clean the signal side of a disc, wipe gently with a soft dry cloth from the center towards the outside edge. Dirt on discs can lower the sound quality, so clean them and always store them in a clean state.
- Do not use any record spray, anti-static solutions, benzene, paint thinner or other chemical agents to clean CDs as they could damage the delicate playing surface. It may cause CDs to become unplayable.
- Do not apply labels or other materials to discs. Do not use discs that have had tape, stickers or other materials applied to their surface. Do not use discs that have sticky residue from stickers, etc. Such discs could become stuck in the unit or cause it to malfunction.
- Never use a commercially available CD stabilizer. Using stabilizers with this player will damage the mechanism and cause it to malfunction.
- Do not use cracked discs.
- Only use circular compact discs. Avoid using non-circular promotional discs, etc.

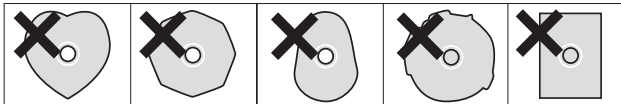

- Music discs with copy control, a copy-protection system, have been released from several record companies in an attempt to protect the copyright. Since some of these discs do not comply with the CD specifications, they may not be playable on the unit.

# 2 – Names and Functions of Parts

## Front panel

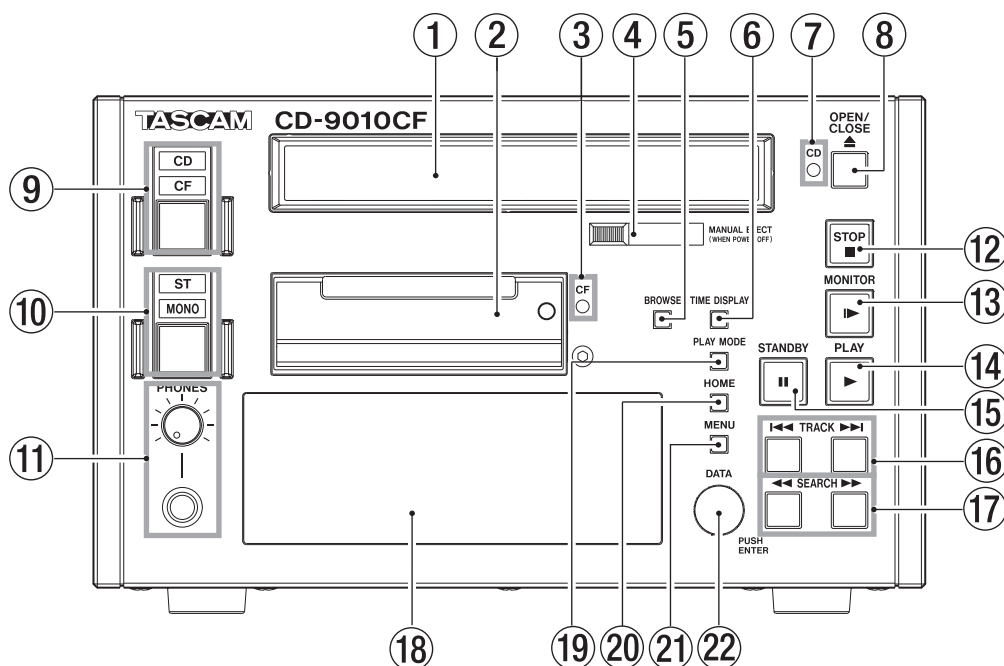

- ① **Disc tray**  
Press the **OPEN/CLOSE** button to open the disc tray to load or remove discs.  
Press the **OPEN/CLOSE** button again to close the disc tray.
- ② **CF card slot**  
Insert and eject CF cards here. (See "Inserting and ejecting CF cards" on page 19.)
- ③ **CF indicator**  
This blinks when a CF card is inserted and data is being read from the card. When data reading is complete, the indicator stays lit and playback is possible.
- ④ **MANUAL EJECT**  
Use this to remove a disc when the power is off.
- ⑤ **BROWSE button**  
Press to open the **BROWSE** screen.  
With data CDs and CF cards, use this screen to look inside folders, for example.  
With audio CDs, use the screen to see its tracks.
- ⑥ **TIME DISPLAY button**  
Press when the Home Screen is open to switch the time display between elapsed track time and remaining track time. This button only changes the display on this unit.  
To change the time display on a connected TASCAM RC-9010/RC-9010S remote control (sold separately), press the **TIME DISPLAY** button on the remote.  
When the Home Screen is open, press and hold this button while turning the **DATA** dial to adjust the display contrast.

### NOTE

*This operation only adjusts the contrast of this unit. It does not adjust the contrast of a connected TASCAM RC-9010/RC-9010S remote control (sold separately).*

- ⑦ **CD indicator**  
This blinks when a CD is loaded. When data reading is complete, the indicator stays lit and playback is possible.
- ⑧ **OPEN/CLOSE button**  
Press this to open the disc tray.

### NOTE

*In order to reduce the amount of time required to remove a disc, the disc tray will open before the disc has completely stopped.*

- ⑨ **CD/CF button and indicators**  
Press to switch between the CD and the CF card as the playback media. The indicator above the button for the selected media lights.
- ⑩ **ST/MONO button and indicators**  
Press to switch between stereo and mono output from the **LINE OUTPUTS**, **MONITOR OUTPUTS** and **PHONES** jack. The indicator for the selected format lights above the button.  
When set to **MONO**, stereo audio tracks will be played back in mono. Use the **MONOMIX** item on the **SYSTEM** menu screen to set the format of the output mono mix. (See "Mono mix setting" on page 43.)
- ⑪ **PHONES jack/knob**  
Use this standard stereo jack to connect stereo headphones. Use the **PHONES** knob to adjust the headphones output level.  
The knob can be pushed in and locked, allowing the unit to be stored and transported safely. To unlock it, push it in again. (See "Connecting headphones" on page 20.)

### CAUTION

*Before connecting headphones, use the **PHONES** knob to lower the volume. Failure to do so might result in sudden loud sounds, which could harm your hearing or result in other trouble.*

- ⑫ **STOP button/indicator**  
Press this button at any time to stop playback at the current point.  
Press this button during online or monitoring playback or when in playback standby to stop playback.  
This button lights when playback is stopped.
- ⑬ **MONITOR button/indicator**  
Press this button to start monitoring playback.  
The playback signal is output through the **MONITOR OUTPUTS (R/L)** and the **PHONES** jack.

## 2 – Names and Functions of Parts

This button lights during monitoring playback.

### 14 **PLAY button/indicator**

Press when playback is stopped or in standby to start playback. This button lights during playback or when in playback standby.

When the **ON LINE** button on a connected TASCAM RC-9010/RC-9010S remote control (sold separately) is lit, or the **SYSTEM** menu **ONLINE FUNCTION** item is set to **ALWAYS ON**, online playback occurs and the playback signal is output through the **LINE OUTPUTS (R/L)** and the **DIGITAL OUTPUT**.

To send the signal through the **MONITOR OUTPUTS (R/L)** and **PHONES** jack, set the **SYSTEM** menu **MON MUTE ONLINE** item to **OFF**. (See "Muting monitoring when online" on page 45.)

This button lights during online playback.

### 15 **STANDBY button/indicator**

When playback is stopped or during jog playback, press this button to pause and start playback standby at the current point.

When in monitoring playback mode and **MONITOR PLAY STBY** is set to **BACK CUE** in the **PLAY** menu, press this button to return to the point at which monitoring playback last started and enter standby. When **MONITOR PLAY STBY** is set to **NORMAL**, press to enter playback standby at the current point.

When using online playback, pressing this button has a different function depending on the playback mode.

Playback mode	Function
CONTINUE or SINGLE	When <b>ONLINE PLAY STBY</b> is set to <b>NORMAL</b> in the <b>PLAY</b> menu, enter playback standby at the current position. When set to <b>BACK CUE</b> , locate to the last cue point and enter playback standby.
PROGRAM	When <b>ONLINE PLAY STBY</b> is set to <b>NORMAL</b> in the <b>PLAY</b> menu, enter playback standby at the beginning of the next track. When set to <b>BACK CUE</b> , locate to the last cue point and enter playback standby.

This button lights when in playback standby.

### 16 **TRACK ◀◀/▶▶ buttons**

Use these buttons to skip between and select tracks.

### 17 **SEARCH ◀◀/▶▶ buttons**

Search while pressing these buttons.

While pressing the **SEARCH ▶▶** (or **SEARCH ◀◀**) button to search, you can change the search speed by pressing the other **SEARCH ◀◀/▶▶** button.

### 18 **Display**

This shows disc information, the operation mode, menus and other data.

### 19 **PLAY MODE button**

When the Home Screen is open, press this button to cycle through the playback modes in the following order.

→ **CONTINUE mode** → **SINGLE mode** → **PROGRAM mode** →

### 20 **HOME button**

When the **MENU** screen, **BROWSE** screen, **PROGRAM** screen or **CUE LIST** screen is open, press this to return to the Home Screen.

Press this button when the Home Screen is open to scroll CD-TEXT file names and data in the information area of the Home Screen.

Press the **MENU** button while pressing and holding this button to turn the panel lock function ON and OFF. (See "Setting the panel lock function" on page 20.)

When the Home Screen is open, press and hold this button while turning the **DATA** dial to adjust the brightness of the display and the indicators.

You can adjust the brightness of the display alone by pressing and turning the **DATA** dial while pressing and holding this button.

#### **NOTE**

*This operation only adjusts the contrast of the display and indicators of this unit. It does not adjust the contrast of a connected TASCAM RC-9010/RC-9010S remote control (sold separately).*

### 21 **MENU button**

Press to open the **MENU** screen.

Press this button while pressing and holding the **HOME** button to turn the panel lock function ON and OFF. (See "Setting the panel lock function" on page 20.)

### 22 **DATA dial**

Turn the **DATA** dial to select items on the **MENU** screen.

Press the dial to use it as an **ENTER** button when confirming operations on the **MENU** screen.

When the Home Screen is open, press and hold the **HOME** button while turning the dial to adjust the brightness of the display and the indicators.

To adjust the brightness of the display alone, press and turn this dial while pressing and holding the **HOME** button.

Press and hold the **TIME DISPLAY** button while turning the **DATA** dial to adjust the display contrast.

#### **NOTE**

*These operations only adjust the brightness and contrast of the display and indicators of this unit. They do not adjust the brightness and contrast of a connected TASCAM RC-9010/RC-9010S remote control (sold separately).*

## 2 – Names and Functions of Parts

### Rear panel

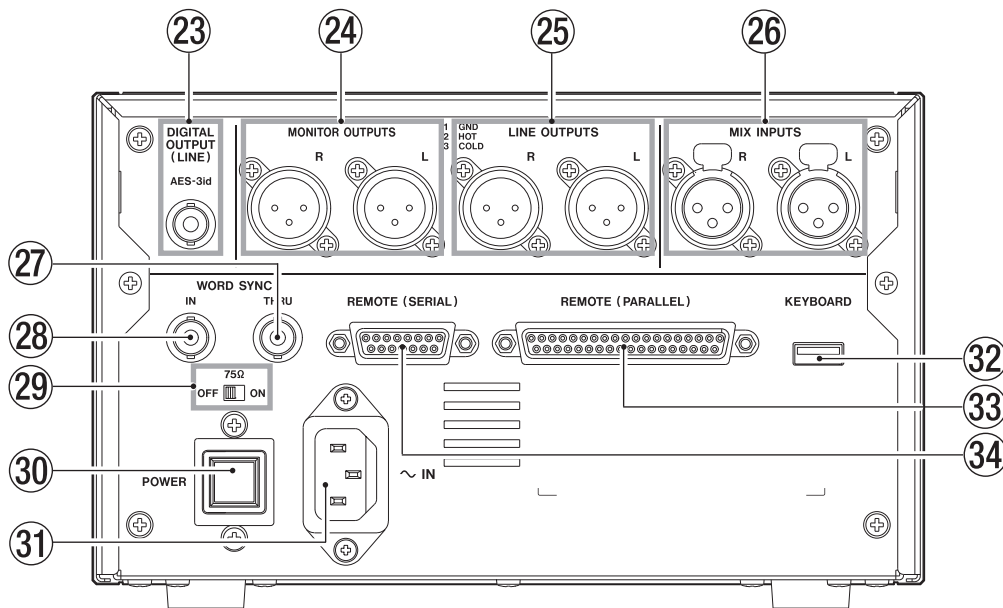

#### 23 DIGITAL OUTPUT

This is an AES-3id digital output. The digital output signal depends on the master clock setting. (See "Setting the master word clock" on page 43.)

#### 24 MONITOR OUTPUTS (R/L) (balanced)

These balanced analog XLR outputs can be connected to a monitoring system. The nominal output level is +4 dBu (or +6 dBu only when the maximum output level is +15 dBu). (1: GND, 2: HOT, 3: COLD)

#### 25 LINE OUT OUTPUTS (R/L) (balanced)

These are balanced analog XLR outputs. The default nominal output level is +4 dBu (+6 dBu only when the maximum output level is +15 dBu), but can be set to -20 dBu. (1: GND, 2: HOT, 3: COLD)

#### 26 MIX INPUTS (R/L) (balanced)

These balanced analog XLR inputs are used for mix input with a nominal output level of +4 dBu. Signals input here are mixed with the playback signal from the CD or CF card and output from the **LINE OUTPUTS**. Even when the power is off, signals input here will be output unchanged through the **LINE OUTPUTS**.

#### 27 WORD SYNC THRU

The input word clock signal is thru output from this connector, allowing it to be sent to other digital devices.

#### 28 WORD SYNC IN

Input a word clock signal through this connector. When this unit is set to use an external clock (EXT), the word clock input through this connector is used.

#### 29 75Ω (ON/OFF) switch

Turns the 75Ω word clock terminator ON or OFF.

#### 30 POWER switch

Turns the power ON or OFF.

#### CAUTION

*Before turning on the power, turn down the volume of other equipment connected to this unit. Failure to do so might cause sudden loud sounds, which could harm your hearing or result in other trouble.*

#### 31 AC IN connector

Connect the included power cord here.

#### 32 KEYBOARD connector

Connect a USB keyboard here.

By default, the unit is set to use a Japanese keyboard. To use a US English keyboard, which is arranged differently from Japanese keyboards, change the setting in the **SYSTEM** menu. (See "Setting the keyboard language" on page 47.)

#### CAUTION

*Do not connect any USB device other than a USB keyboard here.*

#### 33 REMOTE (PARALLEL)

This D-sub 37-pin I/O connector is for parallel control. Use it for external control, including fader starting. (See "Using the parallel connector" on page 50.)

#### 34 REMOTE (SERIAL)

This D-Sub 15-pin I/O connector is for serial control. Connect a TASCAM RC-9010/RC-9010S remote control (sold separately) here.

## 2 – Names and Functions of Parts

### Home Screen

The following information is shown on the display of the unit.

Home Screen with audio CD

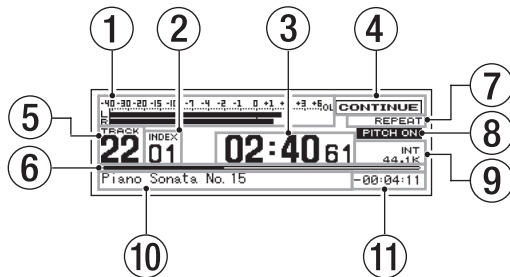

Home Screen with data CD or CF card

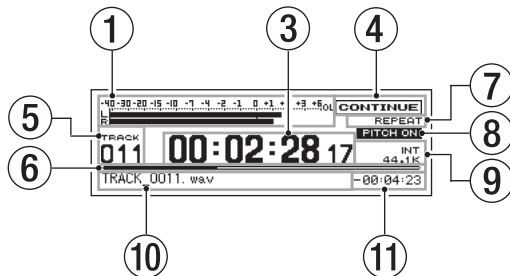

#### ① Playback level meters

These show the playback level.

If you press the **ST/MONO** button to light the **MONO** indicator, only one level bar will be shown and the indicator on the left end will change from LR to 3M, 6M, L, or R, depending to the **SYSTEM** menu **MON MIX** item setting. (See "Mono mix setting" on page 43.)

Even when set to **ST**, if a mono WAV file is played back, the display will change to **M** and a single level bar will be shown.

If you switch the **SYSTEM** menu **METER TYPE** item to **VU** from **PEAK**, the display will change to a **VU**-type meter display. (See "Setting the level meter display type" on page 44.)

#### ② Index

This shows the currently playing or selected index number (audio CD only).

#### ③ Track time display (main area)

This shows the time of the current track.

The contents depend on the playback media.

Media	Contents shown
Audio CD	Minutes, seconds, frames
Data CD	Hours, minutes, seconds, frames
CF card	

Pressing the **TIME DISPLAY** button switches between elapsed time display and remaining time display.

A "-" appears before the remaining time when shown.

When an EOM tally signal is being output, the ":" blinks. (See "EOM functions" on page 27)

#### ④ Playback mode

Shows the current playback mode.

Indicator	Meaning
CONTINUE	Continuous playback mode
SINGLE	Single playback mode
PROGRAM	Program playback mode

#### ⑤ Track number

Shows the current track number.

#### ⑥ Track playback position

Shows the current playback position as a bar. As playback proceeds, the bar extends from the left.

#### ⑦ Repeat playback function indicator

This shows the ON/OFF status of the repeat playback function.

Indicator	Meaning
No indicator	Repeat playback function is OFF
REPEAT	Repeat playback function is ON
REPEAT A-	A-B repeat playback function starting point set
REPEAT A-B	A-B repeat playback function is ON

#### NOTE

The A-B repeat playback function will only be displayed if selected using a TASCAM RC-9010/RC-9010S remote controller (sold separately).

#### ⑧ PITCH indicator

The **PITCH ON** indicator appears if the pitch control function is on.

#### ⑨ Master clock indicator

This shows the current master clock.

Indicator	Meaning
INT	Unit's internal clock in use
EXT	Synchronized with the word clock input through the <b>WORD SYNC IN</b> connector
EXT NO CLK	No signal input through the <b>WORD SYNC IN</b> connector
EXT UNLOCK	<b>WORD SYNC IN</b> connector input signal unlocked
EXT (blinking)	Synchronization with word clock input through the <b>WORD SYNC IN</b> connector possible (after playback completes, the unit will automatically resynchronize with the word clock)
44.1K	Master clock frequency is 44.1 kHz
48K	Master clock frequency is 48 kHz

#### ⑩ Information area

CD-TEXT will be shown if available.

File names will be shown when using data CDs and CF cards. When the playback mode is set to **PROGRAM**, information for the next program item is shown.

#### ⑪ Track time display (sub area)

The time of the current track is shown. When the main display area shows the elapsed time, this shows the remaining time, and vice versa.

A "-" appears before the remaining time when shown.

## 2 – Names and Functions of Parts

### Menu structure

Press the **MENU** button to show the MENU screen.

MENU	
1 PLAY	1 AUTO CUE
2 PROGRAM/CUE	2 AUTO CUE LEVEL
3 REMOTE	3 AUTO READY
4 CF	4 INCREMENTAL PLAY
5 SYSTEM	5 ONLINE BACK CUE
6 INFORMATION	6 PLAY KEY FUNCTION

The menu has six submenus.

1 PLAY	Settings related to playback
2 PROGRAM/CUE	Settings related to program playback and cue point
3 REMOTE	Settings related external remote settings
4 CF	Settings related to CF-specific operations
5 SYSTEM	Settings related to the unit's system.
6 INFORMATION	Settings related to media information and the system version, and operating time confirmation.

The submenu items are as follows.

Main menu item	Submenu item	Function/Setting	Reference
1 PLAY	1 AUTO CUE	Auto Cue	P. 23
	2 AUTO CUE LEVEL	Auto Cue level	P. 23
	3 AUTO READY	Auto Ready	P. 24
	4 INCREMENTAL PLAY	Incremental playback	P. 24
	5 ONLINE BACK CUE	Online back cue function	P. 25
	6 PLAY KEY FUNCTION	Function of PLAY and MONITOR buttons when online OFF	P. 25
	7 MONITOR PLAY STBY	STANDBY button function during monitoring playback	P. 26
	8 ONLINE PLAY STBY	STANDBY button function during online playback	P. 26
	9 REPEAT	Repeat playback function	P. 26
	10 EOM	EOM function	P. 27
	11 END CHECK	END CHECK function	P. 27
	12 PITCH	Pitch control function	P. 28
	13 PITCH %	Pitch control value	P. 28
	14 PITCH/TIME FIT	Time and pitch control playback	P. 28
2 PROGRAM/CUE	1 PROGRAM EDIT	Edit programs	P. 29
	2 PROGRAM IMPORT	Import programs from a CF card	P. 31
	3 PROGRAM EXPORT	Export programs to a CF card	P. 31
	4 CUE LIST EDIT	Edit cue lists	P. 31
	5 CUE LIST IMPORT	Import cue lists from CF cards	P. 34
	6 CUE LIST EXPORT	Export cue lists to CF cards	P. 34
	7 CUE POINT LOAD	Cue point loading	P. 34
3 REMOTE	1 FADER MODE	Fader function for TASCAM RC-9010/RC-9010S or other external remote (sold separately)	P. 48
	2 FADER START MODE	Fader start function for TASCAM RC-9010/RC-9010S or other external remote (sold separately)	P. 48
	3 FADER STOP MODE	Fader stop function for TASCAM RC-9010/RC-9010S or other external remote (sold separately)	P. 48
	4 FADER STOP ACT	Fader stop function action	P. 49
	5 FADER SCALE	Fader scale switching	P. 49
	6 OPERATION PANEL	Panel lock function	P. 20
	7 P.PORT P3/13 ASGN	Parallel remote connector 3-pin and 13-pin functions	P. 50
	8 SERIAL BAUD RATE	Serial remote connector transmission speed (baud rate)	P. 49

## 2 – Names and Functions of Parts

Main menu item		Submenu item		Function/Setting	Reference
4	CF	1	FORMAT (Quick)	Quickly format a CF card	P. 39
		2	FORMAT (Full)	Fully format a CF card	P. 39
		3	RIP CD	Copy a CD to a CF card	P. 40
5	SYSTEM	1	DIGITAL REF LVL	Digital reference level	P. 41
		2	ANALOG REF LVL	Analog output reference level	P. 41
		3	ANALOG REF ADJ L	Adjust the analog output reference level of the L channel	P. 42
		4	ANALOG REF ADJ R	Adjust the analog output reference level of the R channel	P. 42
		5	ONLINE FUNCTION	Online function	P. 42
		6	CLOCK MASTER	Master clock	P. 43
		7	MONO MIX	Mono playback	P. 43
		8	METER TYPE	Meter display	P. 44
		9	FAIL SAFE	Fail-safe function	P. 44
		10	MONITORING POINT	Set monitoring output to before or after the online fader	P. 45
		11	MON MUTE ONLINE	Set automatically mute monitoring during online playback	P. 45
		12	LCD BRIGHTNESS	Display brightness	P. 18
		13	LCD CONTRAST	Display contrast	P. 18
		14	LED BRIGHTNESS	Indicator brightness	P. 18
		15	KEYBOARD	Keyboard type	P. 47
		16	CLOCK ADJUST	Built-in clock adjustment	P. 17
		17	MENU IMPORT	Import and apply MENU settings saved on a CF card	P. 45
		18	MENU EXPORT	Save MENU settings to a CF card	P. 45
		19	FACTORY PRESET	Restore factory settings	P. 46
6	INFORMATION	1	MEDIA INFO	Show information about the media in the current device	P. 46
		2	SYSTEM INFO	Check the system version and operating time	P. 46

## 2 – Names and Functions of Parts

### Menu operation basics

You can perform the following operations using the MENU screen.

#### To select an item (vertically on the screen)

- Turn the **DATA** dial.

The selected menu item appears as light letters on a dark background (highlighted in inverse).

#### To confirm the selected item

- Press the **DATA** dial.

#### To go back one menu level

- Press the **MENU** button.

#### To return directly to the Home screen from the Menu screen

- Press the **HOME** button.

### NOTE

If there are items above or below the currently displayed items in the list, ▲ and/or ▼ will be shown at the top and/or bottom of the list.

### Menu operation procedures

This example explains how to set the auto ready function.

1. Press the **MENU** button to open the MENU screen.

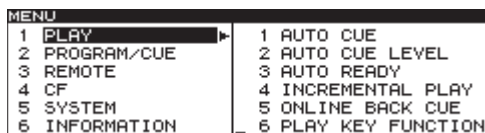

2. Turn the **DATA** dial to select **PLAY**, and press the **DATA** dial to open the **PLAY** menu.

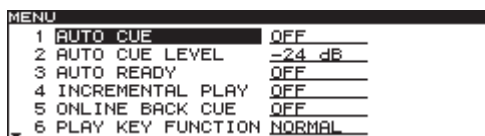

3. Turn the **DATA** dial to select **AUTO READY**, and press the **DATA** dial to highlight the setting value.

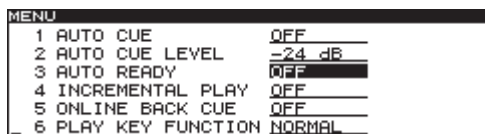

4. Turn the **DATA** dial to set the **AUTO READY** item **ON** or **OFF**.

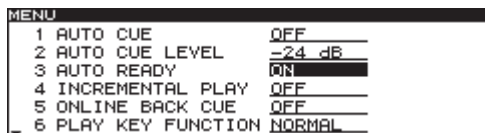

5. Press the **DATA** dial to return to the **PLAY** menu screen.
6. Repeat steps 3–5 as necessary to set other items.
  - To change a menu item or a setting item, press the **MENU** button to show submenu items and return to step 1.
  - To change the selected setting item, turn the **DATA** dial.
7. Press the **HOME** button to return to the Home screen.



# 3 – Preparations

## Turning the power ON and OFF

Press the **POWER** switch on the rear panel to turn the power ON.

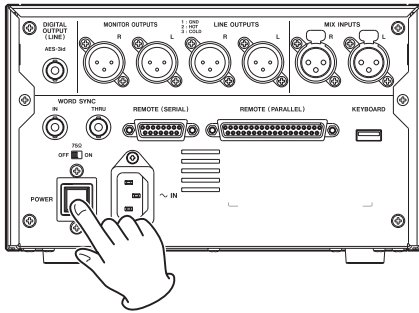

Startup screen



Home Screen

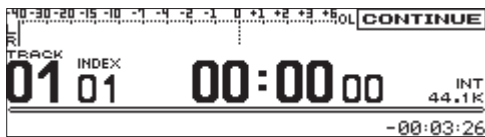

The unit starts and the startup screen appears.

If no media has been loaded in the current device, the screen shows **NO MEDIA**.

If media has been loaded in the current device, the screen shows **MEDIA READING** while the unit reads the media. When this process is complete, the Home Screen is displayed.

## Turning the power OFF

Press the **POWER** switch to turn the power OFF. No special shutdown procedures are necessary.

### CAUTION

*Do not turn the power OFF when the unit is in use (recording, playing back, writing data to a CF card, etc.). Doing so could cause data transfers to fail, corruption of data, sudden loud noise to be emitted from monitoring equipment, damage to equipment and harm to hearing.*

## Setting the date and time

The internal clock is used to add the date and time to files ripped to CF cards.

1. Press the **MENU** button to open the **MENU** screen.

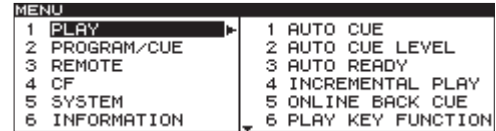

2. The **SYSTEM** menu screen appears.

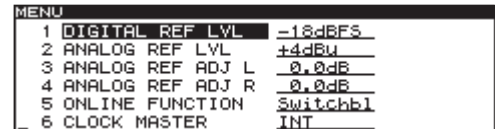

3. Select **CLOCK ADJUST**.

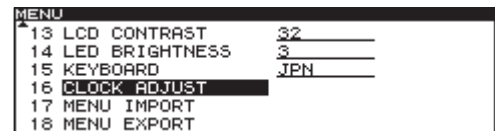

4. Press the **DATA** dial to open the **CLOCK ADJUST** screen.

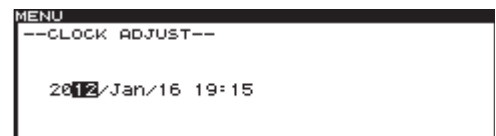

5. Follow these procedures to change the date and time.
  - Press the **DATA** dial to cycle through the year, month and date and select the item to set.
  - Turn the **DATA** dial to change the selected item.
6. After completing the setting, press the **DATA** dial to confirm the set date and time and return to the **SYSTEM** menu screen.
7. Press the **HOME** button to return to the Home Screen.

# 3 – Preparations

## Adjusting the display

You can adjust the display contrast and brightness as necessary.

### Adjusting display contrast

When the Home Screen is open, use the **TIME DISPLAY** button and **DATA** dial to adjust the display contrast.

You can also use **SYSTEM** menu's **LCD CONTRAST** to adjust it.

#### NOTE

- This operation only adjusts the contrast of this unit. It does not adjust the contrast of a connected TASCAM RC-9010/RC-9010S remote control (sold separately).
- The display contrast setting is retained even when the power is OFF.

#### Setting using the controls

With the Home Screen open, while pressing and holding the **TIME DISPLAY** button, turn the **DATA** dial to adjust the unit's display contrast.

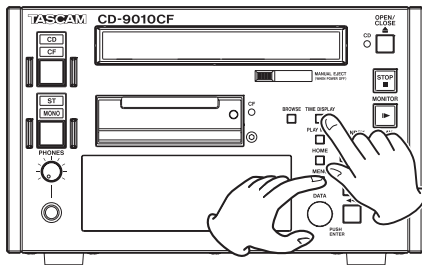

#### Setting using the menu

1. Press the **MENU** button to open the **MENU** screen.
2. Open the **SYSTEM** menu.
3. Select **LCD CONTRAST**.

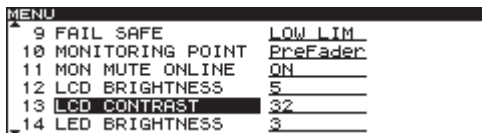

4. Press the **DATA** dial to move the cursor (selected area) right to select the value.
5. Turn the **DATA** dial to adjust the contrast.
  - Options: 0-63 (default value: 32)
6. Press the **HOME** button to return to the Home Screen.

## Adjusting display and indicator brightness

When the Home Screen is open, use the **HOME** button and **DATA** dial to adjust the brightness of the display backlight and the indicators.

You can also use the **SYSTEM** menu screen **LCD BRIGHTNESS** and **LED BRIGHTNESS** items to adjust them.

#### NOTE

- These operations only adjust the brightness and contrast of the display and indicators of this unit. They do not adjust the brightness and contrast of a connected TASCAM RC-9010/RC-9010S remote control (sold separately).
- The display and indicator **BRIGHTNESS** settings are retained even when the power is turned OFF.

#### Setting using the controls

When the Home Screen is open, while pressing and holding the **HOME** button, turn the **DATA** dial to adjust the brightness of the unit's display and indicators.

You can also adjust the brightness of the display alone by pressing and turning the **DATA** dial while pressing and holding the **HOME** button.

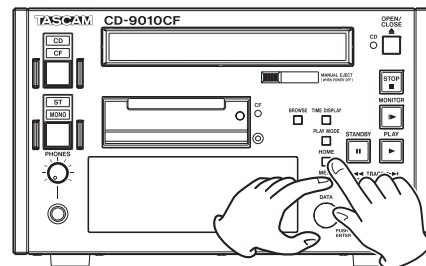

#### Setting using the menu

1. Press the **MENU** button to open the **MENU** screen.
2. Open the **SYSTEM** menu.
3. Select **LCD BRIGHTNESS** or **LED BRIGHTNESS**.

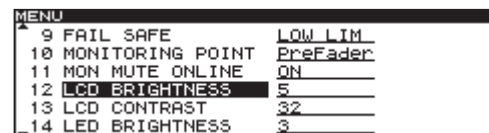

4. Press the **DATA** dial to move the cursor (selected area) right to select the value.

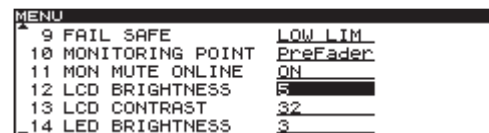

5. Turn the **DATA** dial to adjust the brightness.
  - LCD options: 0-7 (default value: 5)
  - LED options: 0-7 (default value: 3)
6. Press the **HOME** button to return to the Home Screen.

## Inserting and ejecting CF cards

### Inserting CF cards

Insert a CF card into the card slot on the front panel to use it for playback and ripping.

#### NOTE

You can insert CF cards whether the power is ON or OFF.

1. Pull the card slot door forward to open it.

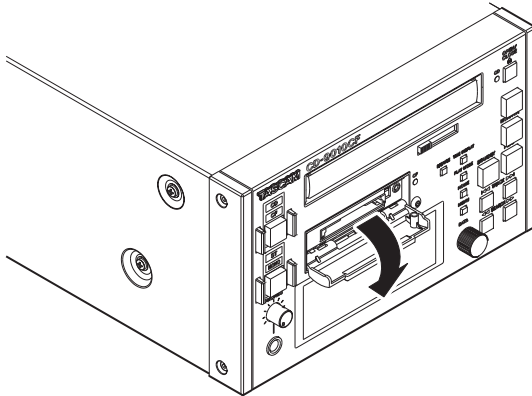

2. Insert the CF card with the label facing up and the contacts facing in.

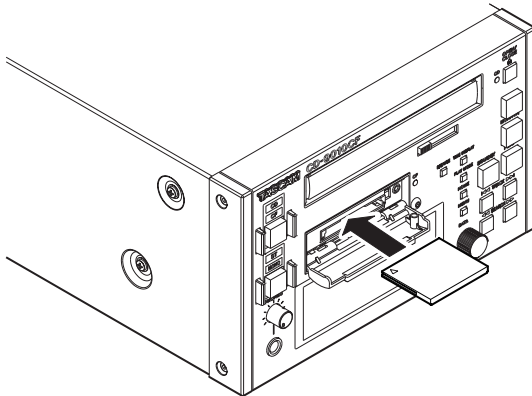

3. Close the card slot door.

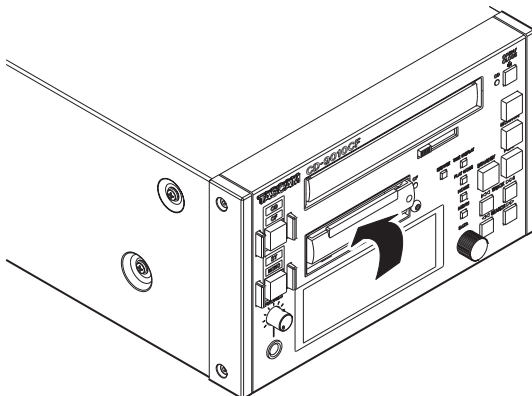

### Ejecting CF cards

Either turn the power off, OR stop all operations before ejecting a CF card.

#### CAUTION

*Never remove a CF card when the unit is in use (playing back, writing data to the card, etc.). Doing so could cause ripping to fail, recorded data to be damaged, sudden loud noises to be emitted from monitoring equipment, damage to equipment and harm to hearing.*

1. Pull the card slot door forward to open it.
2. To eject a CF card, press the square button located at the right of the card slot. The CF card will be partially ejected.

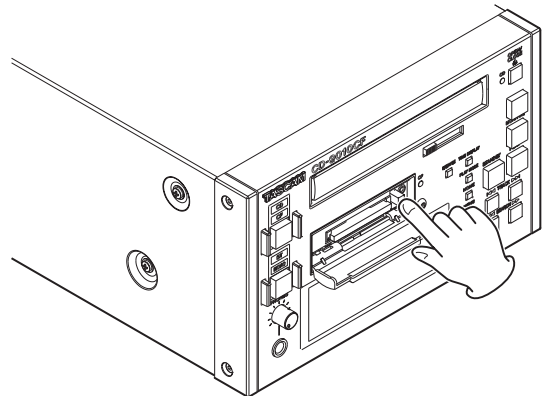

3. Pull the CF card out the rest of the way.

### Using the security screw

The included security screw can be used to lock the card slot door. Use a Phillips screwdriver to install or remove the security screw.

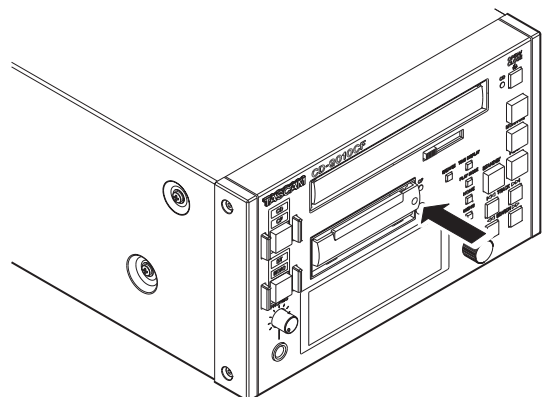

## 3 – Preparations

### Connecting headphones

Connect stereo headphones to the **PHONES** jack on the front panel. Use the **PHONES** knob to adjust the headphones output level.

#### CAUTION

Before connecting headphones, use the **PHONES** knob to lower the volume. Failure to do so might result in sudden loud sounds, which could harm your hearing or result in other trouble.

#### NOTE

The **PHONES** knob can be pushed in to prevent the level from being accidentally changed. The knob can be used when out.

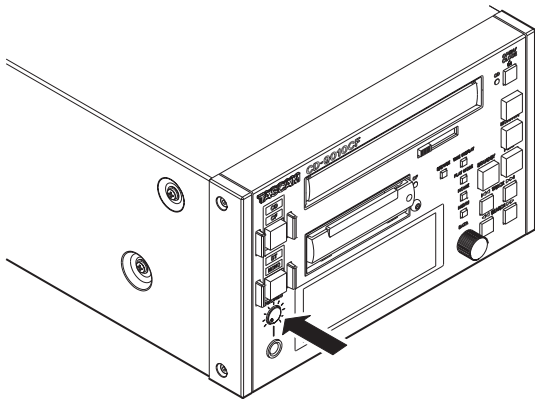

The **PHONES** knob when pushed in

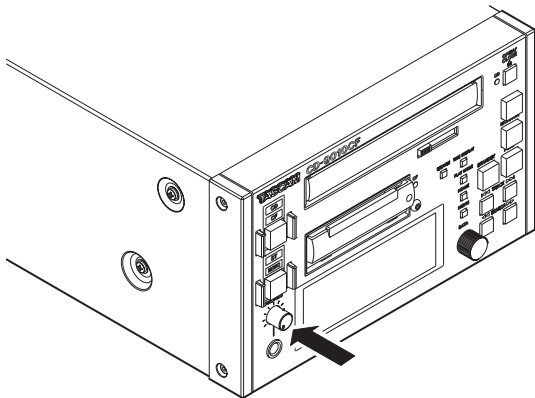

The **PHONES** knob when out

### Setting the panel lock function

The unit can be set so that it can only be operated using a TASCAM RC-9010/RC-9010S remote control (sold separately).

1. Press the **MENU** button to open the **MENU** screen.
2. Open the **REMOTE** menu screen.
3. Select **OPERATION PANEL**.

MENU		
2	FADER START MODE	DISABLE
3	FADER STOP MODE	DISABLE
4	FADER STOP ACT	STANDBY
5	FADER SCALE	0dB MAX
6	OPERATION PANEL	RC ONLY
7	P.PORT P3/13 ASGN	STANDBY

4. Press the **DATA** dial to move the cursor (selected area) right to select the setting.
5. Turn the **DATA** dial to set whether or not you can use the front panel controls to control the unit.
  - **CD+RC**: The unit can be controlled using a TASCAM RC-9010/RC-9010S remote control (sold separately) and the unit's front panel buttons.
  - **RC ONLY** (default value): When a TASCAM RC-9010/RC-9010S remote control (sold separately) is connected, the unit's front panel buttons (other than the **OPEN/CLOSE**, **CD/CF** and **ST/MONO** buttons) are disabled.
6. After completing the setting, press the **HOME** button to return to the Home Screen.

#### NOTE

- When a remote is not connected, even when this item is set to **RC ONLY**, the panel controls will not lock.
- To unlock the panel, press the **MENU** button, while pressing and holding the **HOME** button. When the "OPERATION PANEL Change to CD+RC?" pop-up message appears, select "Yes" to unlock the panel.
- You can also lock the panel controls by pressing the **MENU** button while pressing and holding the **HOME** button. When the pop-up message appears, select "Yes".
- The panel lock function setting is stored even when the power is turned OFF.

## Monitoring and online playback

This unit has two playback modes: monitoring playback and online playback. The outputs for the two playback modes can be set to be independent of each other.

For example, you can use the monitoring playback mode for broadcast use and on location to cue tracks and playback points in advance to prepare for online playback from those points.

### Monitoring playback

The SYSTEM menu ONLINE FUNCTION item must be set to SWITCH, OK to enable monitoring playback. (See "Setting the online function" on page 42.)

#### NOTE

- If set as above, pushing the PLAY button will output the playback signal to the monitoring destination.
- If set as above, the playback signal will be output to the monitoring destination when jogging and searching.

#### Starting monitoring playback

When stopped, in playback standby or during jog playback, press the MONITOR button.

#### Status of outputs

Output	Status
DIGITAL OUTPUT	Off
LINE OUTPUTS	Off
MONITOR OUTPUTS	On

### Online playback

The SYSTEM menu screen ONLINE FUNCTION item must be set to ALWAYS ON to enable online playback. (See "Setting the online function" on page 42.)

#### Starting online playback

When in playback standby, monitoring playback or during jog playback, press the PLAY button.

#### Status of outputs

Output	Status
DIGITAL OUTPUT	On
LINE OUTPUTS	On
MONITOR OUTPUTS	Off

#### NOTE

Set the SYSTEM menu MON MUTE ONLINE item to OFF to always send the signal through the MONITOR OUTPUTS. (See "Muting monitoring when online" on page 45.)

## Setting the playback mode

Tracks on the current device can be played using one of the following three playback modes.

#### Continuous playback mode (default setting)

- The **CONTINUE** indicator appears in the playback mode area of the Home Screen.
- The tracks on the current device are played in track number order.

#### Single playback mode

- The **SINGLE** indicator appears in the playback mode area of the Home Screen.
- Only the currently selected track is played before playback stops.

#### Program playback mode

- The **PROGRAM** indicator appears in the playback mode area of the Home Screen.
- Tracks will be played in the order programmed in advance. (See "Program playback" on page 29.)

The current playback mode appears in the playback mode area of the Home Screen.

Use the **PLAY MODE** button to set the playback mode.

Press this button to cycle through the playback modes in the following order.

→ CONTINUE mode → SINGLE mode → PROGRAM mode →

#### NOTE

- In this manual, unless otherwise specified, explanations assume that the playback mode is set to CONTINUE (continuous playback mode).
- The playback mode setting is retained even when the power is turned OFF.

## 4 – Playback

### Playing a track once from the beginning

Follow these steps to select and check the desired track (monitoring playback), and then play it through the main outputs (online playback). These procedures assume that all menu items are at their default settings.

1. Press the **PLAY MODE** button to select single mode.
  - Press the **PLAY MODE** button as many times as necessary until the **SINGLE** playback mode indicator appears on the Home Screen.
2. Press the **MENU** button to open the **MENU** screen, and set **AUTO CUE** in the **PLAY** menu to **ON**.
3. Press the **HOME** button to open the Home Screen.
4. Use the **TRACK** |◀◀/▶▶| buttons to select a track for playback.
  - The unit enters playback standby at the position where an audio signal is detected in the selected track (and the **STANDBY** button lights).

#### NOTE

*When the playback mode is set to **CONTINUE** or **SINGLE**, you can use the number buttons (0 through 9) to select tracks. Enter two digits for audio CDs or three digits for data CDs or CF cards. (For example, press the 0 button followed by the 2 button to select track 2 on an audio CD.)*

5. To check the playback signal, press the **MONITOR** button to start monitoring playback (the **MONITOR** button lights).
  - In addition to using an external monitoring system, you can also monitor the playback signal using headphones connected to the unit's **PHONES** jack.
6. After checking the signal, press the **STANDBY** button.
  - The playback position is set to the point where the track starts and the unit enters playback standby mode (the **STANDBY** button lights).
7. Press the **PLAY** button to start online playback.
  - When the track ends, the unit re-enters playback standby.
  - Press the **STOP** button to stop playback immediately.

### Playing a track from the middle

Follow these steps to find a point in the middle of a track and start playback from the main outputs from that point.

1. When stopped or during playback standby, you can search within a track using the **SEARCH** ◀◀/▶▶ buttons to locate a desired point and put the unit in playback standby there. (See "Searching within tracks" on page 23.)
2. At the desired playback point, press the **MONITOR** button to start monitoring playback and check it.
3. After checking, press the **STANDBY** button to return to the point set earlier and start online playback standby (**STANDBY** button lights).
  - To adjust the set point, return to step 1.
4. Press the **PLAY** button to start online playback.  
When the track ends, the unit will enter playback standby mode.

#### NOTE

*Press the **STOP** button to stop playback immediately.*

### Automatic cue point memory (last cue)

When you start monitoring playback from a stopped or playback standby state, the starting position is automatically memorized as a cue point.

The most recently added cue point is the "last cue point". Press the **STANDBY** button to locate to the last cue point (where monitoring playback last started) and enter playback standby.

#### NOTE

- *When using a **TASCAM RC-9010/RC-9010S** remote control (sold separately), you can assign automatic cue points to the number (0–9) buttons.*
- *In jog mode, pressing the **STANDBY** button saves the current position as a cue point.*

## Setting the playback point

### Selecting tracks

Use the **TRACK** **◀◀/▶▶** buttons to select tracks.

#### ◀◀ button

Press to move to the start of the current track when the elapsed time of the current track is greater than one second. When the elapsed time is less than one second, press this to skip to the beginning of the previous track.

#### ▶▶ button

Press to skip to the beginning of the next track. Press again to skip to the beginning of the track after that.

#### NOTE

- *When in program playback mode, tracks will be skipped in the program order.*
- *When at the beginning of the first track, press the ◀◀ button to skip to the beginning of the last track. When at the beginning of the last track, press the ▶▶ button to skip to the beginning of the first track.*

## Operation after selection of a track

When the **TRACK** **◀◀/▶▶** buttons are used to select a track, what happens next depends on the unit's status and auto cue function setting. (See "Auto cue function" on page 23.)

#### When Auto Cue is ON

The unit enters playback standby at the first position within the track where the signal reaches the level set using the **PLAY** menu **AUTO CUE LEVEL** item.

#### When Auto Cue is OFF

The unit enters playback standby at the beginning of the track.

## Searching within tracks

When playback is stopped, the unit is in playback standby, or during monitoring or jog playback, press and hold the **SEARCH** **◀◀/▶▶** buttons to search for a cue point.

While pressing one of the **SEARCH** **▶▶** or **◀◀** buttons to search within a track, you can change the search speed by pressing the other **SEARCH** **◀◀/▶▶** button.

## Auto cue function

If the auto cue function is ON, and you select a track for playback, any "silence" at the beginning of the track will be skipped, and the unit will enter playback standby at the first point where the track's "signal" is audible. As a result, sound will be heard immediately when playback starts.

#### NOTE

- *When using the cue function, the Auto Cue function is disabled.*
- *If a track is selected when AUTO CUE is ON, the unit enters playback standby at the first point where the track is audible.*
- *The AUTO CUE function setting is retained even when the power is turned OFF.*

You can specify the threshold level (**AUTO CUE LEVEL**) used to detect the audio signal when the Auto Cue function is activated. In other words, any signal higher than the **AUTO CUE LEVEL** will be treated as "signal," and any signal lower than this level will be treated as "silence."

1. Press the **MENU** button to open the **MENU** screen.
2. Open the **PLAY** menu.
3. Select **AUTO CUE**.

MENU	
1	<b>AUTO CUE</b> OFF
2	<b>AUTO CUE LEVEL</b> -24 dB
3	<b>AUTO READY</b> OFF
4	<b>INCREMENTAL PLAY</b> OFF
5	<b>ONLINE BACK CUE</b> OFF
6	<b>PLAY KEY FUNCTION</b> NORMAL

4. Press the **DATA** dial to move the cursor right to select the setting.
5. Turn the **DATA** dial to set the value to **ON** (default is **OFF**).
6. Press the **DATA** dial to move the cursor to the left, and return to menu item selection.
7. Select **AUTO CUE LEVEL**.

MENU	
1	<b>AUTO CUE</b> OFF
2	<b>AUTO CUE LEVEL</b> -24 dB
3	<b>AUTO READY</b> OFF
4	<b>INCREMENTAL PLAY</b> OFF
5	<b>ONLINE BACK CUE</b> OFF
6	<b>PLAY KEY FUNCTION</b> NORMAL

8. Press the **DATA** dial to move the cursor right to select the setting.
9. Turn the **DATA** dial to set the desired auto cue level.
  - Values: -24 dB to -72 dB (6 dB steps, default -24 dB)
10. After setting the value, press the **HOME** button to return to the Home Screen.

## 4 – Playback

### Auto ready function

If the auto ready function is ON, when a track finishes playing, playback standby will occur at the beginning of the next track.

1. Press the **MENU** button to open the **MENU** screen.
2. Open the **PLAY** menu screen.
3. Select **AUTO READY**.

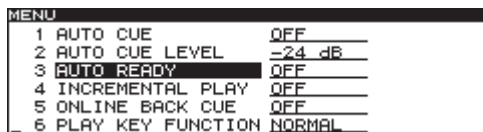

MENU		
1	AUTO CUE	OFF
2	AUTO CUE LEVEL	-24 dB
3	AUTO READY	OFF
4	INCREMENTAL PLAY	OFF
5	ONLINE BACK CUE	OFF
6	PLAY KEY FUNCTION	NORMAL

3. Press the **DATA** dial to move the cursor right to select the setting.
4. Turn the **DATA** dial to set the value to **ON** (default is **OFF**).
5. After setting the value, press the **HOME** button to return to the Home Screen.

#### NOTE

- If the auto cue function is set to **ON**, the unit enters playback standby at the point where sound starts in the next track rather than at the very beginning of the track.
- The auto ready function setting is retained even when the power is turned **OFF**.

### Incremental playback function

When the incremental playback function is **ON**, and the unit is playing back, you can use the **PLAY** button to start playback from the beginning of the next track or the **STOP** button to enter playback standby at the beginning of the next track.

1. Press the **MENU** button to open the **MENU** screen.
2. Open the **PLAY** menu screen.
3. Select **INCREMENTAL PLAY**.

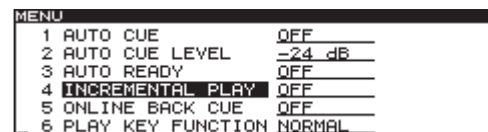

MENU		
1	AUTO CUE	OFF
2	AUTO CUE LEVEL	-24 dB
3	AUTO READY	OFF
4	INCREMENTAL PLAY	OFF
5	ONLINE BACK CUE	OFF
6	PLAY KEY FUNCTION	NORMAL

4. Press the **DATA** dial to move the cursor right to select the setting.
5. Turn the **DATA** dial to set the value to **ON** (default is **OFF**).
6. After setting the value, press the **HOME** button to return to the Home Screen.

#### NOTE

- When the incremental playback function is set to **ON** and the unit is in playback standby mode, pressing the **PLAY** button will start playback from that position. In playback standby, pressing the **STOP** button will stop playback.
- When the last track of the current device is being played, pressing **PLAY** starts playback of the first track on the current device media. Pressing **STOP** pauses at the beginning of the first track on the current device.
- The incremental playback function setting is retained even when the power is turned **OFF**.



## ONLINE BACK CUE function

If this function is on, when the **ON LINE** button is turned OFF on a connected TASCAM RC-9010/RC-9010S remote control (sold separately), the unit immediately enters playback standby at the last cue point (the last point where monitoring playback started).

1. Press the **MENU** button to open the MENU screen.
2. Open the **PLAY** menu screen
3. Select **ONLINE BACK CUE**.

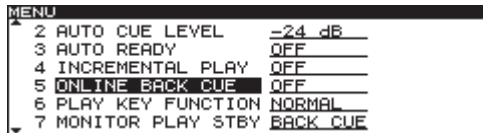

4. Press the **DATA** dial to move the cursor right to select the setting.
5. Turn the **DATA** dial to set the value to **ON** (default is OFF).
6. After setting the value, press the **HOME** button to return to the Home Screen.

### NOTE

The **ONLINE BACK CUE** function setting is retained even when the power is turned OFF.

## PLAY KEY FUNCTION setting

When the **ON LINE** button is turned OFF on a connected TASCAM RC-9010/RC-9010S remote control (sold separately), the **PLAY** button operates as described below.

### When set to Normal

Pressing the **PLAY** button during playback has no effect. If **INCREMENTAL PLAY** is set to **ON**, however, pressing the **PLAY** button during playback allows incremental playback.

### When set to Back Cue

If the incremental play function is OFF, pressing the **PLAY** button skips to the last cue point and continues playback. Pressing the **PLAY** button in this case activates monitoring playback (monitoring outputs ON, line outputs OFF).

1. Press the **MENU** button to open the MENU screen.
2. Open the **PLAY** menu screen.
3. Select **PLAY KEY FUNCTION**.



4. Press the **DATA** dial to move the cursor right to select the setting.
5. Turn the **DATA** dial to set the function when online playback mode is OFF (default is OFF).  
Values are **NORMAL** (default value) and **BACK CUE**.
6. After setting the value, press the **HOME** button to return to the Home Screen.

### NOTES

- Similar operation is possible using the **MONITOR** button.
- The **PLAY KEY FUNCTION** setting is retained even when the power is turned OFF.

# 4 – Playback

## MONITOR PLAY STBY function

You can set how the **STANDBY** button functions during monitoring playback.

1. Press the **MENU** button to open the **MENU** screen.
2. Open the **PLAY** menu screen
3. Select **MONITOR PLAY STBY**.

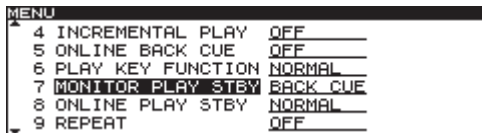

4. Press the **DATA** dial to move the cursor right to select the setting.
5. Turn the **DATA** dial to set the **STANDBY** button function during monitoring playback.
  - **NORMAL**: Start playback standby at that point
  - **BACK CUE** (default value): Pause and enter playback standby mode at the last cue point
6. After setting the value, press the **HOME** button to return to the Home Screen.

### NOTE

The **MONITOR PLAY STBY** setting is retained even when the power is turned **OFF**.

## ONLINE PLAY STBY function

You can set how the **STANDBY** button functions during online playback.

1. Press the **MENU** button to open the **MENU** screen.
2. Open the **PLAY** menu screen
3. Select **ONLINE PLAY STBY**.

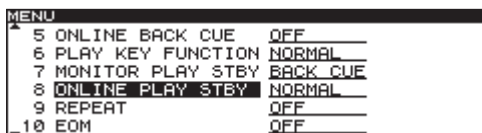

4. Press the **DATA** dial to move the cursor right to select the setting.
5. Turn the **DATA** dial to set the function of the **STANDBY** button during online playback
  - **NORMAL** (default value): If the playback mode is **CONTINUE** or **SINGLE**, start playback standby at that point. If the playback mode is **PROGRAM**, start playback standby at the beginning of the next track.
  - **BACK CUE**: Pause and start playback standby at the last cue point.
6. After setting the value, press the **HOME** button to return to the Home Screen.

### NOTE

The **ONLINE PLAY STBY** setting is retained even when the power is turned **OFF**.

## Repeat playback

You can repeatedly play back all tracks on the media in the current device.

### Ordinary repeat playback

When the repeat playback function is **ON**, depending on the current playback mode, the following will occur:

- **CONTINUE**: the entire disc is played back repeatedly
- **SINGLE**: the current track is played back repeatedly
- **PROGRAM**: the entire program is played back repeatedly

1. Press the **MENU** button to open the **MENU** screen.
2. Open the **PLAY** menu screen.
3. Select **REPEAT**.

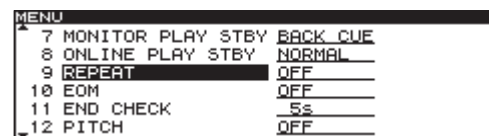

4. Press the **DATA** dial to move the cursor right to select the setting.
5. Turn the **DATA** dial to set the value to **ON** (default is **OFF**).
6. After completing the setting, press the **HOME** button to return to the Home Screen.

### To turn repeat playback OFF

- Set the **PLAY** menu **REPEAT** item to **OFF**.

### NOTE

The **repeat playback** setting is retained even when the power is turned **OFF**.

## EOM functions

You can set the unit to output EOM tally signals from the **CONTROL I/O PARALLEL** connector when the remaining time on the track is less than the time set here using the EOM function.

### Setting EOM tally output trigger

Set the track remaining time that triggers output of an EOM tally signal.

1. Press the **MENU** button to open the **MENU** screen.
2. Open the **PLAY** menu screen.
3. Select **EOM**.

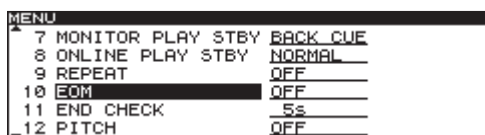

4. Press the **DATA** dial to move the cursor right to select the setting.
5. Turn the **DATA** dial to set the track remaining time to trigger the EOM tally.
  - Options: **OFF** (default value), **0s**, **5s–35s** (in 5-second increments)

#### NOTE

If **EOM TRACK** is set to **0s**, when the track ends, a pulse of about **100 ms** will be output.

5. After completing the setting, press the **HOME** button to return to the Home Screen.

#### NOTE

The **EOM** function setting is retained even when the power is turned **OFF**.

## How to use the EOM

1. Connect the device that will receive the EOM tally signal to the **REMOTE (PARALLEL)** connector.
2. Turn **ON** the power of this unit and the receiving device.
3. Begin playback from this unit.
  - When the remaining time of the current track falls below the specified time, an EOM tally signal is output from the **REMOTE (PARALLEL)** connector.

While the EOM tally signal is being output, the ":" in the Home Screen track time display (main display area) blinks.

## Checking the ends of tracks

To check how tracks end, turn the **END CHECK** function **ON**.

### Setting the amount of time checked

Set the time before the end of the track when checking starts.

1. Press the **MENU** button to open the **MENU** screen.
2. Open the **PLAY** menu screen.
3. Select **END CHECK**.

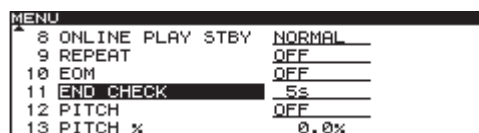

4. Press the **DATA** dial to move the cursor right to select the setting.
5. Turn the **DATA** dial to set the time before the end of the track that checking starts.
  - Options: **5** (default value) –**35** (in 5 second increments)
6. After completing the setting, press the **HOME** button to return to the Home Screen.

#### NOTE

The **END CHECK** function setting is retained even when the power is turned **OFF**.

## How to use the end check function

When using a **TASCAM RC-9010/RC-9010S** remote control (sold separately), press the **TRACK/[END CHK]** button while pressing and holding the **SHIFT** button to locate to a point at the set number of seconds before the end of the currently selected track and start monitoring playback.

After playback of the last part of the track completes, the unit enters playback standby mode at the last cue point.

# 4 – Playback

## Pitch control playback

You can modify the pitch and speed of the playback, following the procedures here.

### Turning pitch control playback ON/OFF

1. Press the **MENU** button to open the **MENU** screen.
2. Open the **PLAY** menu screen.
3. Select **PITCH**.

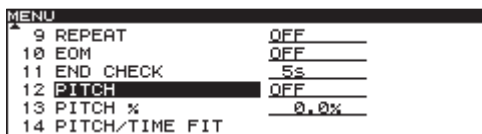

4. Press the **DATA** dial to move the cursor right to select the setting.
5. Turn the **DATA** dial to set pitch control **ON** or **OFF** (default is **OFF**).
6. After completing the setting, press the **HOME** button to return to the Home Screen.

#### NOTE

When you turn pitch control playback **ON** or **OFF** during playback, the playback sound may be momentarily interrupted.

### Setting the pitch control value

1. Press the **MENU** button to open the **MENU** screen.
2. Open the **PLAY** menu screen.
3. Select **PITCH %**.

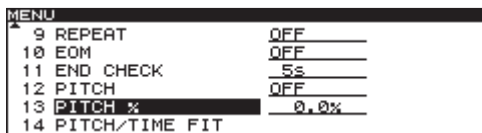

4. Press the **DATA** dial to move the cursor right to select the setting.
5. Turn the **DATA** dial to set the pitch control value.
  - You can set the pitch control to  $\pm 12.5\%$  of normal.
6. After completing the setting, press the **HOME** button to return to the Home Screen.

#### NOTE

- Even when the pitch control function is turned **OFF**, the pitch control value set above is stored and will be used when the pitch control function is turned **ON** again.
- The pitch step setting is retained even when the power is turned **OFF**.

## PITCH/TIME FIT function

You can adjust the time remaining of the current track to a defined value and play it back.

The possible setting range corresponds to a pitch control value range of  $\pm 12.5\%$ .

This setting can be made when stopped or in playback standby.

1. Press the **MENU** button to open the **MENU** screen.
2. Open the **PLAY** menu screen.
3. Select **PITCH/TIME FIT**.

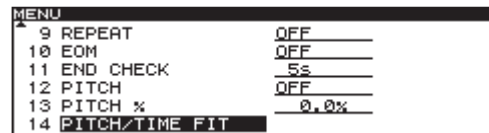

4. Press the **DATA** dial to open the **PITCH/TIME FIT** screen.

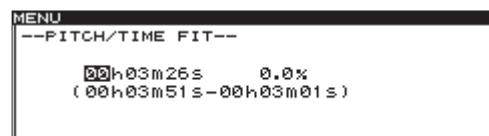

5. Set the playback time as follows:
  - The current track remaining time is shown initially.
  - Turn the **DATA** dial to change the selected item.
  - Press the **DATA** dial to select the playback time units in hours, minutes and seconds order. The permissible range (maximum and minimum) is shown beneath the input line.
6. After completing the setting, press the **DATA** dial to confirm the setting.

The setting is saved and reflected in the pitch control value, and the **PLAY** menu screen re-opens.
7. Press the **HOME** button to return to the Home Screen.

# 5 – Program and cue playback

## Program playback

You can create a program in advance to play up to 99 tracks you want in the desired order.

### Program menu operation

Select PROGRAM EDIT and press the DATA dial to open the PROGRAM screen (program list). Select the desired item, and press the DATA dial to open the PROGRAM MENU pop-up with the following options.

#### ADD PROGRAM

Adds the highlighted track to the program.

#### DELETE ALL PROGRAM

Removes all tracks from the program.

#### DELETE PROGRAM

Removes the selected program track.

#### MOVE

Move the selected program track to a different position in the program order.

#### CANCEL

Close the PROGRAM MENU without conducting any operation and return to the PROGRAM screen.

## Adding tracks to a program

Follow these procedures to set up a program.

1. With playback stopped, press the PLAY MODE button and set the playback mode to PROGRAM (See "Setting the playback mode" on page 21.)
2. Press the MENU button to open the MENU screen.
3. Open the PROGRAM/CUE menu.

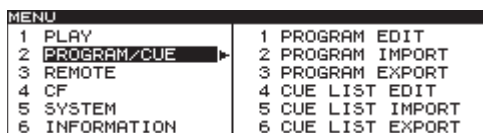

4. Select PROGRAM EDIT.



5. Press the DATA dial to open the PROGRAM screen.



6. Turn the DATA dial to select the number in the program where a track will be added, and press the DATA dial to open the PROGRAM menu.

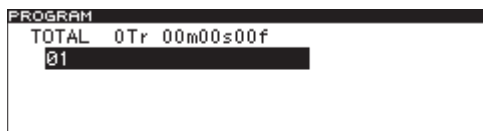

7. Turn the DATA dial to select ADD PROGRAM.

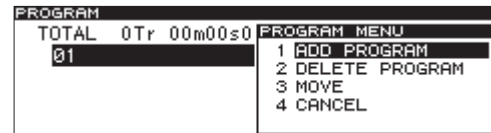

8. Press the DATA dial to open the BROWSE (ADD PROGRAM) screen.

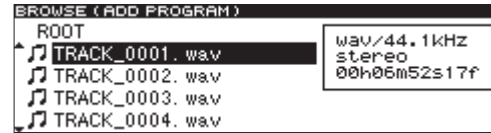

9. Turn the DATA dial to program to select a track, and press the DATA dial to add the track to the program.

### NOTE

You can create programs that include tracks from both a CD and a CF card. Press the CD/CF button when the BROWSE (ADD PROGRAM) screen is open to switch devices. A program can only include tracks from one CD and one CF card.

10. Repeat steps 6–9 to add more tracks to the program as desired.

The screen shows the number of tracks in the program and the total program time.

### NOTES

- You can add the same track to the program more than once.
- You can add a maximum of 99 tracks to a program. If you try to program a 100th track, a PROGRAM FULL warning message pop-up appears.
- If the total time of the programmed tracks exceeds 99 hours 59 minutes, 59 seconds, "--:--:--" appears on the display.
- A program can only include tracks from one CD and one CF card. After tracks have been added to a program from one CD (CF card), if you try to add a track using a different CD (CF card), a "--Cannot Program--" message will appear and the track will not be added.

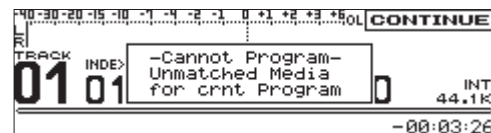

11. When you have finished entering tracks to the program, press the HOME button to return to the Home Screen.
12. Press the MONITOR button or PLAY button to start program playback.

### NOTES

- If you set PROGRAM playback mode but no tracks have been added to the program, the setting will change to CONTINUE when playback starts.
- Program settings are retained even when the power is turned OFF.
- If you try to start program playback when a CD (CF card) that is different from the one used by the program, a "--Can't Play Program--" message will appear and playback will not start.



# 5 – Program and cue playback

## Clearing a program

1. Press the **MENU** button to open the **MENU** screen.
2. Open the **PROGRAM/CUE** menu screen
3. Select **PROGRAM EDIT**.
4. Press the **DATA** dial to open the **PROGRAM** screen.
5. Turn the **DATA** dial to select **TOTAL**.
6. Press the **DATA** dial to open the **PROGRAM** menu.
7. Turn the **DATA** dial to select **DELETE ALL PRGRM**.

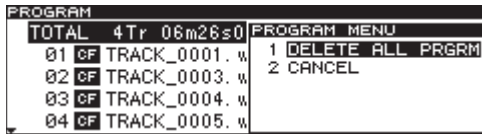

8. Press the **DATA** dial to clear the entire program. When the program has been cleared, the **PROGRAM** screen reopens and **TOTAL 0Tr 00m00s00f** appears.



9. Press the **HOME** button to return to the Home Screen.

## Removing tracks from a program

1. Press the **MENU** button to open the **MENU** screen.
2. Open the **PROGRAM/CUE** menu screen
3. Select **PROGRAM EDIT**.
4. Press the **DATA** dial to open the **PROGRAM** screen.
5. Turn the **DATA** dial to select the track you want to remove.
6. Press the **DATA** dial to open the **PROGRAM** menu.
7. Turn the **DATA** dial to select **DELETE PROGRAM**.

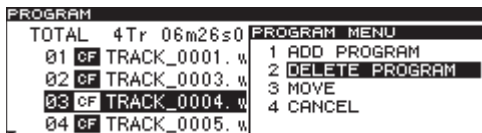

8. Press the **DATA** dial to remove the selected track.  
After the track is removed, the **PROGRAM** screen reopens.

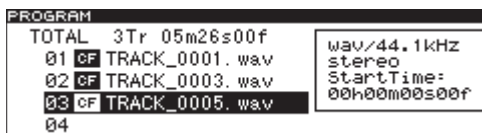

9. Press the **HOME** button to return to the Home Screen.

## Moving tracks within a program

1. Press the **MENU** button to open the **MENU** screen.
2. Open the **PROGRAM/CUE** menu screen
3. Select **PROGRAM EDIT**.
4. Press the **DATA** dial to open the **PROGRAM** screen.
5. Turn the **DATA** dial to select the track to move
6. Press the **DATA** dial to open the **PROGRAM** menu.
7. Turn the **DATA** dial to select **MOVE**.

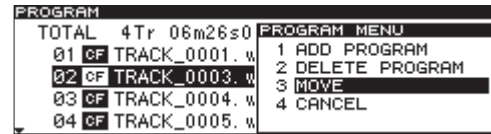

8. Press the **DATA** dial. The track to be moved blinks.

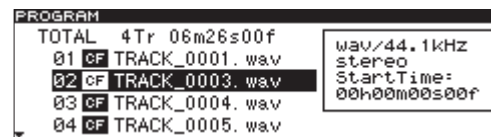

9. Turn the **DATA** dial to move the track to the desired position.

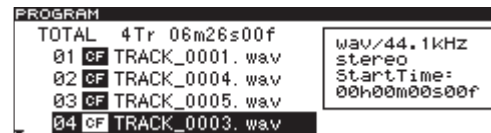

10. Press the **DATA** dial to confirm the new position. When the track move is confirmed, the **PROGRAM** screen reopens.

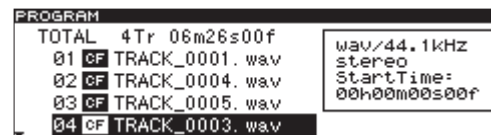

11. Press the **HOME** button to return to the Home Screen.

## Importing programs

1. Insert a CF card containing a program list into the CF card slot.
2. Press the **MENU** button to open the **MENU** screen.
3. Open the **PROGRAM/CUE** menu screen
4. Select **PROGRAM IMPORT**.



5. Press the **DATA** dial. A confirmation pop-up message appears.



6. Press the **DATA** dial once more to start importing the program.
7. When the program import is complete, the pop-up disappears and the **PROGRAM/CUE** menu reopens.
8. Press the **HOME** button to return to the Home Screen.

## Exporting programs

1. Insert the CF card on which the exported program list will be saved into the CF card slot.
2. Press the **MENU** button to open the **MENU** screen.
3. Open the **PROGRAM/CUE** menu screen
4. Select **PROGRAM EXPORT**.



5. Press the **DATA** dial. A confirmation pop-up message appears.



6. Press the **DATA** dial again to start exporting the program.
7. When the program export is complete, the pop-up disappears and the **PROGRAM/CUE** menu screen reopens.
8. Press the **HOME** button to return to the Home Screen.

## Cue point playback

You can locate to and play back from cue points you have set earlier. You can set up to nine cue points for each CD and CF card. CD cue points can be save for up to 500 discs. CF card cue points are saved on the card itself, so there is no limit to the number of cards with saved cue points.

### Using the cue menu

Select **CUE LIST EDIT** and press the **DATA** dial to open the **CUE** screen (cue list). Select the desired item, and press the **DATA** dial to open the **CUE MENU** pop-up.

#### ADD CUE

Add a cue point at the current playback position.

#### DELETE ALL CUE

Clear all cue points from the cue list.

#### DELETE CUE

Clear the selected cue point.

#### EDIT CUE TITLE

Open the **EDIT CUE TITLE** screen where you can edit the name of the selected cue point. (See "Editing cue point names" on page 33.)

#### CANCEL

Close the **CUE** menu without performing any operation, and return to the **CUE** screen.

### Adding cue points

Follow these procedures to add cue points.

1. Press the **MENU** button to open the **MENU** screen.
2. Open the **PROGRAM/CUE** menu screen and select **CUE LIST EDIT**.



3. Press the **DATA** dial to open the **CUE** list screen.



4. Turn the **DATA** dial to select the cue point number to add.
5. Press the **DATA** dial to open the **CUE** menu.



6. Turn the **DATA** dial to select **ADD CUE**.

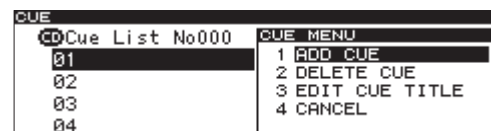

# 5 – Program and cue playback

7. Press the **DATA** dial to add the cue point. The current time of the track being played back (or in standby) will be added as a cue point to the cue list.
8. Repeat steps 5–7 to add cue points as desired.  
The screen shows the track numbers and cue points.
9. When you are done adding cue point, press the **HOME** button to return to the Home Screen.

### NOTE

*CUE settings are retained even when the power is OFF.*

## Clearing the cue list

1. Press the **MENU** button to open the **MENU** screen.
2. Open the **PROGRAM/CUE** menu screen and select **CUE LIST EDIT**.
3. Press the **DATA** dial to open the **CUE** screen.
4. Turn the **DATA** dial to select **Cue List**.
5. Press the **DATA** dial to open the **CUE** menu.
6. Turn the **DATA** dial to select **DELETE ALL CUE**.

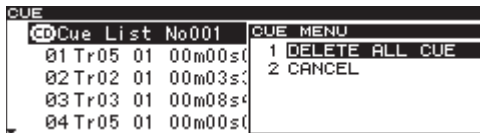

7. Press the **DATA** dial to clear all cue points in the cue list.  
After the cue points have been cleared, the **CUE** list screen reopens.



8. Press the **HOME** button to return to the Home Screen.

## Clearing a cue point

1. Press the **MENU** button to open the **MENU** screen.
2. Open the **PROGRAM/CUE** menu screen and select **CUE LIST EDIT**.
3. Press the **DATA** dial to open the **CUE** list screen.
4. Turn the **DATA** dial to select the cue point to be cleared
5. Press the **DATA** dial to open the **CUE** menu.
6. Turn the **DATA** dial to select **DELETE CUE**.

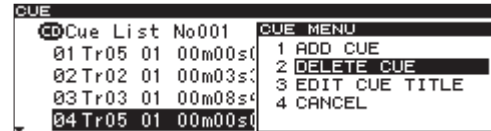

7. Press the **DATA** dial to clear the highlighted cue point.  
After the cue point has been cleared, the **CUE** list screen reopens.

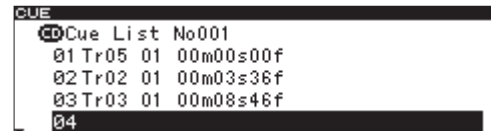

8. Press the **HOME** button to return to the Home Screen.



## Editing cue point names

1. Press the **MENU** button to open the **MENU** screen.
2. Open the **PROGRAM/CUE** menu screen
3. Select **CUE LIST EDIT**.
4. Press the **DATA** dial to open the **CUE** screen.
5. Turn the **DATA** dial to select the cue point with the name to be edited, and press the **DATA** dial to open the **CUE** menu.
6. Turn the **DATA** dial to select **EDIT CUE TITLE**.

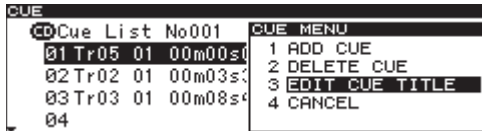

7. Press the **DATA** dial to open the **EDIT CUE TITLE** screen.



8. Edit the cue point name. See "Editing text" below for instructions
9. When you are done editing the name, press the **BROWSE** button to confirm the name change and return to the **CUE** list screen.

### NOTE

- Names containing characters other than the letters of the alphabet, numbers and symbols cannot be edited.
- The following symbols and punctuation marks cannot be used in names.  
¥/:;,\*?"<>|
- Cue point names can be up to six single-byte characters in length.
- You can connect a USB computer keyboard to the **KEYBOARD** connector on the rear panel of the unit and use it to edit text. (See "9 – Operation using a computer keyboard" on page 47.)

## Editing text

Edit text using the following operations.

**To move the editing (cursor) position**  
Use the **SEARCH** ◀◀/▶▶ buttons.

**To change the character at the cursor position**  
Turn the **DATA** dial.

**To confirm the character at the cursor position**  
Press the **DATA** dial.

**To insert an empty space**  
Press the **TRACK** ▶▶| button.

**To delete a character**  
Press the **TRACK** |◀◀ button.

**To confirm and end editing**  
Press the **BROWSE** button.

# 5 – Program and cue playback

## Importing cue lists

1. Insert a CF card containing a cue list into the CF card slot.
2. Press the **MENU** button to open the **MENU** screen.
3. Open the **PROGRAM/CUE** menu screen
4. Select **CUE LIST IMPORT**.



5. Press the **DATA** dial and a confirmation pop-up message appears.



6. Press the **DATA** dial again to start importing the cue list.
7. When the cue list has finished importing, the pop-up disappears and the **PROGRAM/CUE** menu screen reopens.
8. Press the **HOME** button to return to the Home Screen.

## Exporting cue lists

1. Insert the CF card where the cue list will be exported into the CF card slot.
2. Press the **MENU** button to open the **MENU** screen.
3. Open the **PROGRAM/CUE** menu screen.
4. Select **CUE LIST EXPORT**.



5. Press the **DATA** dial and a confirmation pop-up message appears.



6. Press the **DATA** dial again to start exporting the cue list.
7. When the cue list has finished exporting, the pop-up disappears, and the **PROGRAM/CUE** menu screen reopens.
8. Press the **HOME** button to return to the Home Screen.

## Automatic cue point loading options

Usually when a disc for which cue points have already been saved is loaded, the previous cue points are automatically loaded. Sometimes, though, you might not want to use the memorized cue points.

You can set whether or not memorized cue points are automatically loaded.

1. Press the **MENU** button to open the **MENU** screen.
2. Open the **PROGRAM/CUE** menu screen.
3. Select **CUE POINT LOAD**.



4. Press the **DATA** dial to move the cursor to the right and select the setting.



5. Turn the **DATA** dial to change the setting for memorized cue point loading.
  - **LOAD** (default): Automatically load previously memorized cue points
  - **UNLOAD**: Do not load memorized cue points
  - **SELECT**: Every time the power is turned ON, a pop-up menu appears that lets you decide whether or not to load cue points. The setting you select stays active until the power is turned OFF again.

Pop-up that appears when set to **SELECT**

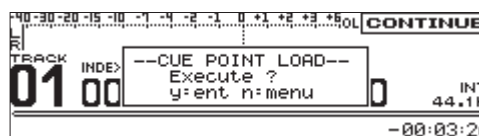

6. Press the **DATA** dial again to set the cue list load setting, and return to the **PROGRAM/CUE** menu screen.
7. Press the **HOME** button to return to the Home Screen.

### NOTE

When set to **UNLOAD** (or when set to **SELECT** and you chose not to load cue points), the unit will function as follows.

- New cue points that are added will not be saved.
- When the active device is changed, all cue points will be cleared.
- When the setting is changed from **UNLOAD** to **LOAD** (and vice versa), the change will become effective the next time the unit is turned ON again. (The cue list will not be loaded immediately when set to **LOAD**.)
- When set to **UNLOAD**, exporting the cue points will not export the recently added ones. (It will export the points added when last set to **LOAD**.)

# 6 – Working with files and folders

Using the **BROWSE** screen, you can manage audio files on CF cards in a folder structure. You can also manage WAV files on a data CD in a folder structure. You can select folders and files, and then enter folders and work with files.

When working with CF cards, you can create folders, edit the names of folders and files, and delete folders and files, for example.

## NOTE

*You cannot use this screen with unfinalized data CDs containing WAV files.*

## TIP

*By using a card reader or other interface connected to a computer to read files on a CF card, you can modify the folder structure, edit folder and file names, and delete folders and files using the computer. If you perform this type of editing from your computer, be aware that the playback order of the files on the unit may change.*

## Opening the BROWSE screen

The following operations assume that a CF card or a data CD containing WAV files is loaded.

When stopped, in playback standby or playing back, press the **BROWSE** button to open the **BROWSE** screen.



When in playback standby, the **BROWSE** screen for the folder containing the currently selected file opens and that file is highlighted.

## Navigating the BROWSE screen

When the **BROWSE** screen is open, use the **DATA** dial to select folders and files.

- Press the **DATA** dial to open the **BROWSE MENU** pop-up for that file or folder. (See “File operations” on page 35 and “Folder operations” on page 36.)
- When the **BROWSE** menu is open, press the **BROWSE** button to close the **BROWSE** menu.
- When a folder or file is selected, press the **BROWSE** button to scroll through folder and file names.
- When the **BROWSE** screen is open, press the **HOME** button to return to the Home Screen.
- When a file or folder is selected, press the **PLAY** button to return to the Home Screen and play that file or folder.
- When a file or folder is selected, press the **STANDBY** button to return to the Home Screen and put that file or folder into playback standby.

## Icons on the BROWSE screen

The icons that appear on the **BROWSE** screen have the following meanings.

### Folder (📁)

Folders are shown with this icon.

### Audio file (🎵)

The names of music files appear next to these icons.

Track titles are shown when CD-TEXT is available.

## File operations

Select the desired audio file on the **BROWSE** screen, and press the **DATA** dial to open the file **BROWSE MENU** pop-up.

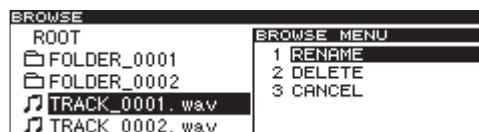

Turn the **DATA** dial to select the desired item, and press the **DATA** dial to execute one of the following operations.

### RENAME

Opens the **RENAME** screen where you can edit the selected file name. (See “Editing file names (CF cards)” on page 37.)

### DELETE

Deletes the selected file. (See “Deleting folders and files (CF cards)” on page 37.)

### CANCEL

Cancels any operation with the selected file, closes the **BROWSE MENU** and returns to the **BROWSE** screen.

# 6 – Working with files and folders

## Folder operations

Select the desired folder on the BROWSE screen, and press the DATA dial to open the folder BROWSE MENU pop-up.

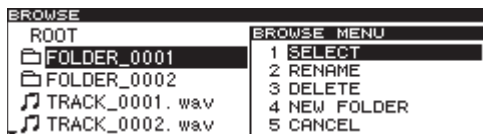

Turn the DATA dial to select the desired item, and press the DATA dial to execute one of the following operations.

### NOTE

All the BROWSE MENU functions can be used with CF cards. Only some of the functions can be used with data CDs with WAV files.

### SELECT

Opens the selected folder.

### RENAME (CF card)

Opens the RENAME screen where you can edit the selected folder name. (See "Editing folder names (CF cards)" on page 36.)

### DELETE (CF card)

Deletes the selected item. (See "Deleting folders and files (CF cards)" on page 37.)

### NEW FOLDER (CF card)

Creates a new folder. (See "Creating new folders (CF cards)" on page 38.)

### CANCEL

Cancels any operation with the selected folder, closes the BROWSE MENU and returns to the BROWSE screen.

## Editing folder names (CF cards)

1. Select the folder that you want to edit, and turn the DATA dial to select RENAME.
2. Press the DATA dial to open the RENAME screen.



3. Edit the folder name. Follow the instructions in "Editing text" on page 33.
4. When you have finished editing the folder name, press the BROWSE button to confirm the change.

The words -- FILE ACCESS -- and a progress bar appear in a pop-up while the folder name is being changed.

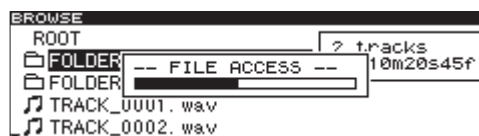

After the folder name has been changed, the BROWSE screen reopens.

### NOTE

- Names containing characters other than the letters of the alphabet, numbers and symbols cannot be edited (the name will not appear when the RENAME function is being used).
- The following symbols and punctuation marks cannot be used in names.  
¥ / : ; , \* ? " < > |
- Folder names can be up to 52 characters (single-byte) long. The full path on the BROWSE screen cannot exceed 255 characters (system limitation). So, the maximum number of characters for a subfolder within a folder, including the names of all folders above it and separators, is 255.
- You can connect a USB computer keyboard to the KEYBOARD connector on the rear panel of the unit and use it to edit text. (See "9 – Operation using a computer keyboard" on page 47.)

## 6 – Working with files and folders

### Editing file names (CF cards)

1. Select the folder that you want to edit, and turn the **DATA** dial to select **RENAME**.
2. Press the **DATA** dial to open the **RENAME** screen.



3. Edit the file name. Follow the instructions in "Editing text" on page 33.
4. When you have finished editing the file name, press the **BROWSE** button to confirm the change.

The words **-- FILE ACCESS --** and a progress bar appear in a pop-up while the file name is being changed.



After the file name has been changed, the **BROWSE** screen reopens.

#### NOTE

- You can also directly access CF cards from a computer to change the names of files, but doing so could change the previous playback order of the files.
- Changing file names using the procedures above will reorder the files by character code and might cause the playback order to change.
- Names that contain characters other than the letters of the alphabet, numbers and symbols cannot be edited (the name will not appear when the **RENAME** function is being used).
- The following symbols and punctuation marks cannot be used in names.  
¥/:;,\*? "<>|
- File names can be up to 52 characters (single-byte) long. The full path on the **BROWSE** screen cannot exceed 255 characters (system limitation). So, the maximum number of characters for a file within a folder, including the names of all folders above it and separators, is 255.
- You can connect a USB computer keyboard to the **KEYBOARD** connector on the rear panel of the unit and use it to edit text. (See "9 – Operation using a computer keyboard" on page 47.)

### Deleting folders and files (CF cards)

You can delete folders and files from CF cards. If you delete a folder, all the files in it will also be deleted.

1. Select the folder or file to delete, and turn the **DATA** dial to select **DELETE**.



2. Press the **DATA** dial and a confirmation pop-up message appears.



To cancel the deletion, press the **MENU** button.

3. To confirm the deletion, press the **DATA** dial.

The words **-- FILE ACCESS --** and a progress bar appear in a pop-up while the item is being deleted from the card.



After deletion is complete, the **BROWSE** screen reopens.

#### NOTE

If you try to delete a file that has been added to a program, a "P.LIST Registered DELETE Execute?" confirmation message will appear.

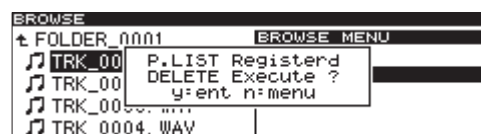

# 6 – Working with files and folders

## Creating new folders (CF cards)

1. Select the folder where you want to create a new subfolder, and turn the **DATA** dial to select **NEW FOLDER**.

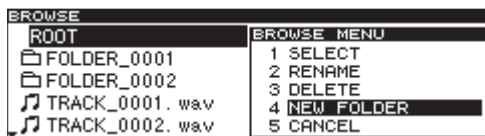

2. Press the **DATA** dial to open the **NEW FOLDER** screen.



3. Input the name for the new folder. Follow the instructions in "Editing text" on page 33.
4. After you have completed entering the folder name, press the **BROWSE** button to confirm it.

The words **-- FILE ACCESS --** and a progress bar appear in a pop-up while the folder is created and the new folder is created.



After creation is complete, the **BROWSE** screen reopens.

### NOTE

- Names containing characters other than the letters of the alphabet, numbers and symbols cannot be edited (the name will not appear when the **RENAME** function is being used).
- The following symbols and punctuation marks cannot be used in names.  
 ¥/:;,\*?"<>|
- A maximum of 52 characters (single-byte) can be used for folder names. Moreover, due to limitations of the system, the full path on the **BROWSE** screen cannot exceed 255 characters. For example, the maximum number of characters for a file or subfolder within a folder, including the folders above it and separators, is 255.
- Up to 255 folders can be created on a single CF card.
- When using media with a capacity of 2 GB or less, the maximum number of folders created in the root folder might be less than 255 (file system limitations). A maximum of 255 folders, including subfolders, can be created.
- You can connect a USB computer keyboard to the **KEYBOARD** connector on the rear panel of the unit and use it to edit text. (See "9 – Operation using a computer keyboard" on page 47.)

## File and folders on CF cards and data CDs

Some CF cards and data CDs store files inside folders in the same way that ordinary computers do. In addition, several folders can be stored inside another folder, creating a multilevel structure.

This unit assigns a folder number to each folder to manage them. Folder numbers are assigned sequentially starting with the folders at the highest level followed by the folders (subfolders) inside them.

If the root folder of a CF card or data CD contains one or more audio files, it will be numbered as the first folder.

Each audio file is also assigned a number. File numbers are assigned in order starting from those in the lowest numbered folder.

During ordinary playback of CF cards and data CDs, tracks are played back in the assigned numerical order just like those on audio CDs.

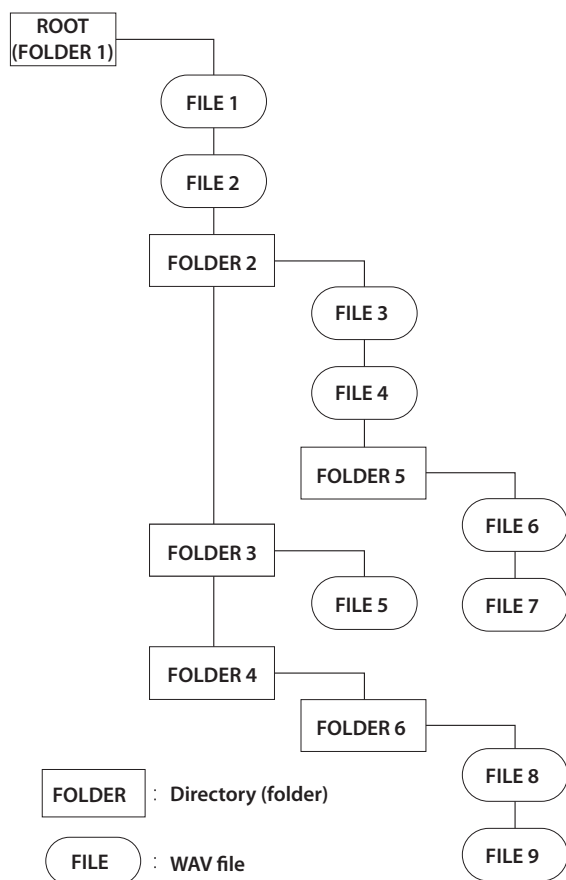

Data CD structure

# 7 – Managing CF cards

## Formatting CF cards quickly

Use **FORMAT (Quick)** to format a CF card in a short amount of time.

Formatting a CF card erases all the data on it.

1. Press the **CD/CF** button to activate the CF card. The **CF** indicator above the **CD/CF** button lights when it is active.
2. Press the **MENU** button to open the **MENU** screen.
3. Open the **CF** menu screen.
4. Select **FORMAT (Quick)**.



5. Press the **DATA** dial and a confirmation pop-up message appears.



6. Press the **DATA** dial again to start formatting.  
The words **--FORMAT--** and a progress bar appear in a pop-up while the card is being formatted.
  - Select **n=menu** to cancel formatting.
- 7.. When formatting is complete, the pop-up disappears and the Home Screen reopens.

## Formatting CF cards (full format)

Use the **FORMAT (Full)** item to format a CF card completely. Formatting a CF card will erase all the data on it.

Full formatting checks the CF card's memory for errors while formatting, so the process takes more time than quick formatting.

1. Press the **CD/CF** button to activate the CF card. The **CF** indicator above the **CD/CF** button lights when it is active.
2. Press the **MENU** button to open the **MENU** screen.
3. Open the **CF** menu screen.
4. Select **FORMAT (Full)**.



5. Press the **DATA** dial and a confirmation pop-up message appears.

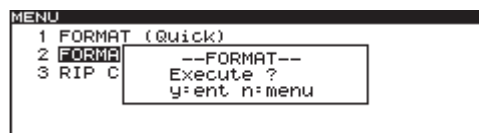

6. Press the **DATA** dial again to start formatting.  
The words **--FORMAT--** and a progress bar appear in a pop-up while the card is being formatted.
  - Select **n=menu** to cancel formatting.
7. When formatting is complete, the pop-up disappears and the Home Screen reopens.

# 7 – Managing CF cards

## Ripping CD tracks to CF cards

You can rip (convert and copy) audio from audio CDs to CF cards. The audio from CDs is converted into and written as WAV files. The following procedures assume that the current device is set to CD, and the CD with the track that you want to copy and a CF card are loaded.

1. Press the **MENU** button to open the **MENU** screen.
2. Open the **CF** menu screen.
3. Select **RIP CD**.



4. Press the **DATA** dial.  
The words **--MEDIA READING--** and a progress bar appear in a pop-up.



### NOTE

If a CF is not loaded, after **MEDIA READING**, **--ERROR--** and **CF READ** appear in a pop-up. Insert a CF card.

5. After a CF card has been completely loaded, the **RIP SOURCE SELECT** screen opens.



6. Turn the **DATA** dial to select the source track to be copied. Select **CD-DA DISC** to select the entire disc as the source. The remaining available space on the CF card is shown at the top right of the screen.



7. After selecting the tracks to copy, press the **DATA** dial to confirm the selection.

The **RIP TARGET SELECT** screen opens where you can select the destination for the copied tracks opens.

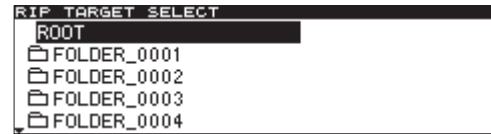

### NOTE

When selecting source files, if the size of the ripped data would exceed the remaining capacity of the CF card, or the number of source tracks would cause the number of files to exceed the CF card limit, **CAPACITY OVER** or **TRACK FULL** will appear and you will not be able to continue to step 8.

8. On the **RIP TARGET SELECT** screen, turn the **DATA** dial to select the destination for the copied tracks (a folder) and press the **DATA** dial to open it. Then turn the **DATA** dial and select **-RIP HERE-** in the first line of a folder to select it as the destination folder.



9. With **-RIP HERE-** selected, press the **DATA** dial to confirm the destination. A confirmation pop-up message appears.



10. Press the **DATA** dial again to start writing to the CF card. During this process, **-- RIPPING --** and a progress bar appear in a pop-up.



When writing is complete, the CD menu screen reopens.



# 8 – Other settings and information display

## Setting the digital reference level

You can set the digital headroom (number of dB below maximum analog output reference level (full scale)).

1. Press the **MENU** button to open the **MENU** screen.
2. Open the **SYSTEM** menu.
3. Select **DIGITAL REF LVL**.

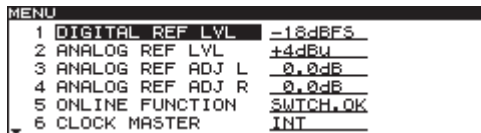

4. Press the **DATA** dial to move the cursor right to select the setting.
5. Turn the **DATA** dial to set the digital reference level.
  - Options: -20dBFS, -18dBFS (default value), -16dBFS, -14dBFS, -9dBFS
6. After completing the setting, press the **HOME** button to return to the Home Screen.

### NOTE

The digital reference level setting is retained even when the power is turned OFF.

## Setting the analog reference level

You can set the analog output reference level.

The analog audio output reference level settings that are possible depend on the digital reference level setting.

1. Press the **MENU** button to open the **MENU** screen.
2. Open the **SYSTEM** menu.
3. Select **ANALOG REF LVL**.

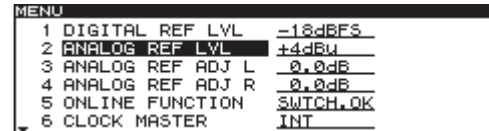

4. Press the **DATA** dial to move the cursor right to select the setting.
5. Turn the **DATA** dial to set the analog reference level. The analog reference setting value options depend on the **DIGITAL REF LVL** setting.

DIGITAL REF LVL setting	ANALOG REF LVL setting
-9dBFS	+6dBu only
Settings other than -9dBFS	-20dBu, +4dBu (default value)

6. After completing the setting, press the **HOME** button to return to the Home Screen.

### NOTE

- The -20dBu setting does not effect the **MONITOR OUTPUTS**. When this setting is selected, the output from the **MONITOR OUTPUTS** will be +4 dBu unless the digital reference level is set to -9 dBFS.
- This analog reference level setting is retained even when the power is turned OFF.

## 8 – Other settings and information display

### Adjusting R/L analog reference levels

You can adjust the analog output reference level separately for the left and right channels.

1. Press the **MENU** button to open the MENU screen.
2. Open the **SYSTEM** menu
3. Select **ANALOG REF ADJ L** or **ANALOG REF ADJ R**.

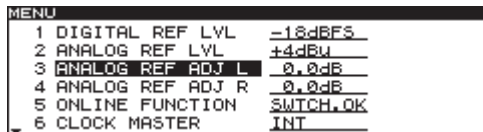

MENU	
1	DIGITAL REF LVL -18dBFS
2	ANALOG REF LVL +4dBu
3	ANALOG REF ADJ L 0.0dB
4	ANALOG REF ADJ R 0.0dB
5	ONLINE FUNCTION SWITCH_OK
6	CLOCK MASTER INT

4. Press the **DATA** dial to move the cursor right to select the setting.
5. Turn the **DATA** dial to adjust the analog reference level.
  - Setting range:  $\pm 6.0$  dB (default value: 0dB, 0.1dB increments)
6. After completing the setting, press the **HOME** button to return to the Home Screen.

#### NOTE

The analog reference level settings are retained even when the power is turned OFF.

### Setting the online function

You can set whether or not to use the online function.

1. Press the **MENU** button to open the MENU screen.
2. Open the **SYSTEM** menu.
3. Select **ONLINE FUNCTION**.

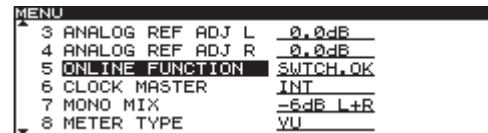

MENU	
3	ANALOG REF ADJ L 0.0dB
4	ANALOG REF ADJ R 0.0dB
5	ONLINE FUNCTION SWITCH_OK
6	CLOCK MASTER INT
7	MONO MIX -6dB L+R
8	METER TYPE VU

3. Press the **DATA** dial to move the cursor right to select the setting.
4. Turn the **DATA** dial to set the online function.
  - **SWITCH\_OK** (default value): Online playback mode can be controlled through the parallel remote connector, the serial remote connector, and by a TASCAM RC-9010/RC-9010S remote controller (sold separately). When this unit is used alone, online playback mode is ON by default.
  - **AlwaysON**: Online playback mode is always ON and cannot be switched.
6. After completing the setting, press the **HOME** button to return to the Home Screen.

#### NOTE

The online function setting is retained even when the power is turned OFF.

# 8 – Other settings and information display

## Setting the master word clock

You can set the source to use for word synchronization.

1. Press the **MENU** button to open the **MENU** screen.
2. Open the **SYSTEM** menu.
3. Select **CLOCK MASTER**.

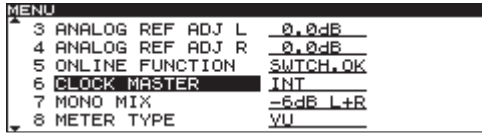

4. Press the **DATA** dial to move the cursor right to select the setting.
5. Turn the **DATA** dial to set the master word clock.
  - **INT** (default value): Use the unit's internal clock
  - **EXT**: Synchronize with the word clock input through the **WORD SYNC IN** connector
  - **44.1K FIX**: Regardless of the file sampling frequency, digital audio is always output at 44.1k FS.
6. After completing the setting, press the **HOME** button to return to the Home Screen.

### NOTE

- The master clock setting is retained even when the power is turned OFF.
- Depending on the combination of master clock and playback file sampling frequency settings, the digital output sampling frequency will differ. (See "Master clock and digital output combinations" below.)

## Mono mix setting

You can set the mono mix output for when the **STEREO/MONO** button is used to set the output to mono. The setting state is shown to the left of the level meters.

1. Press the **MENU** button to open the **MENU** screen.
2. Open the **SYSTEM** menu.
3. Select **MONO MIX**.

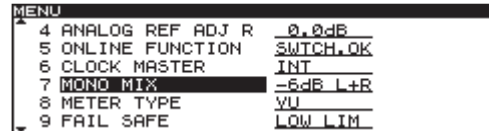

4. Press the **DATA** dial to move the cursor right to select the setting.
5. Turn the **DATA** dial to set the mono mix.

-6dB L+R (default value)	The left and right channels of the stereo audio track are each attenuated by -6 dB, summed and then output.
-3dB L+R	The left and right channels of the stereo audio track are each attenuated by -3 dB, summed and then output.
L Mono	The left channel of the stereo audio track is output from both L and R outputs.
R Mono	The right channel of the stereo audio track is output from both L and R outputs.

6. After completing the setting, press the **HOME** button to return to the Home Screen.

### NOTE

The mono mix setting is retained even when the power is turned OFF.

## Master clock and digital output combinations

Depending on the combination of the master clock setting and the playback file sampling frequency, the digital output sampling frequency varies. This table shows the combinations.

Master clock	Master clock setting	Playback file sampling frequency	SRC (automatic)	Digital output sampling frequency	Notes
Internal	INT	44.1 kHz	OFF	44.1 kHz	The whole system uses 44.1kHz internal clock
	44.1kHz FIX	44.1 kHz	OFF	44.1 kHz	Digital output is always 44.1 kHz
	44.1kHz FIX	48 kHz	ON	44.1 kHz	Digital output is always 44.1 kHz
	INT	48 kHz	OFF	48 kHz	The whole system uses 48kHz internal clock
External (44.1kHz)	EXT	44.1 kHz	OFF	44.1 kHz	The whole system uses 44.1kHz external clock
External (48kHz)	EXT	44.1 kHz	ON	48 kHz	While syncing to 48kHz external clock, the system uses 44.1kHz internal clock
	EXT	48 kHz	OFF	48 kHz	The whole system uses 48kHz external clock

### NOTE

- The sampling rate converter (SRC) function is turned ON and OFF automatically.
- If the clock is interrupted when synchronized with a 48kHz external clock, the unit will switch to internal clock, the sampling rate converter (SRC) function will turn ON and output will continue at 48 kHz.

# 8 – Other settings and information display

## Setting the level meter display type

You can change the type of the playback level meters on the Home Screen.

1. Press the **MENU** button to open the **MENU** screen.
2. Open the **SYSTEM** menu.
3. Select **METER TYPE**.

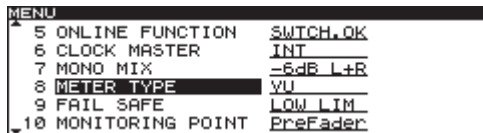

4. Press the **DATA** dial to move the cursor right to select the setting.
5. Turn the **DATA** dial to set the type of level meters shown.
  - **PEAK**: Peak meters shown
  - **VU** (default value): VU meters shown.
6. After completing the setting, press the **HOME** button to return to the Home Screen.

### NOTE

The level meter type setting is retained even when the power is turned OFF.

## Fail safe function setting

The fail safe function prevents the accidental operation of buttons. Different buttons are disabled during playback and online playback. See the table below for details

1. Press the **MENU** button to open the **MENU** screen.
2. Open the **SYSTEM** menu.
3. Select **FAIL SAFE**.

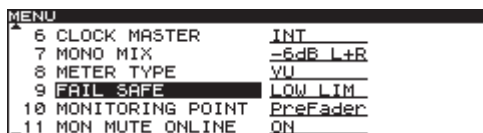

4. Press the **DATA** dial to move the cursor (selected area) right to select the setting.
5. Turn the **DATA** dial to set the fail safe function.
 

Options: **LOW LIM** (default value), **UP LIM**, **OFF**
6. After completing the setting, press the **HOME** button to return to the Home Screen.

### NOTE

The fail safe setting is retained even when the power is turned OFF.

Buttons disabled according to fail safe setting

Fail safe setting	Disabled buttons during playback standby	Disabled buttons during online playback
LOW LIM	None	CD/CF button
		ST/MONO button
		BROWSE button
		PLAY MODE button
		MENU button
		ENTER button
		OPEN/CLOSE button
		TRACK I◀◀/▶▶ buttons
		SEARCH ◀◀/▶▶ buttons
		MONITOR button
UP LIM	CD/CF button	CD/CF button
	ST/MONO button	ST/MONO button
	BROWSE button	BROWSE button
	---	PLAY MODE button
	MENU button	MENU button
	ENTER button	ENTER button
	OPEN/CLOSE button	OPEN/CLOSE button
	---	STANDBY button
	TRACK I◀◀/▶▶ buttons	TRACK I◀◀/▶▶ buttons
	SEARCH ◀◀/▶▶ buttons	SEARCH ◀◀/▶▶ buttons
---	MONITOR button	
OFF	None	None

## 8 – Other settings and information display

### Monitoring point setting

You can set whether the monitoring output signal is from before or after the Online fader.

1. Press the **MENU** button to open the MENU screen.
2. Open the **SYSTEM** menu.
3. Select **MONITORING POINT**.

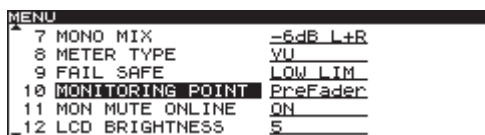

4. Press the **DATA** dial to move the cursor right to select the setting.
5. Turn the **DATA** dial to set the monitoring point.
  - **PreFader** (default value): Monitor the signal before the Online fader
  - **PstFader**: Monitor the signal after the Online fader
6. After completing the setting, press the **HOME** button to return to the Home Screen.

#### NOTE

The monitoring point setting is retained even when the power is turned OFF.

### Muting monitoring when online

You can set whether or not monitoring output is automatically muted during online playback.

1. Press the **MENU** button to open the MENU screen.
2. Open the **SYSTEM** menu.
3. Select **MON MUTE ONLINE**.

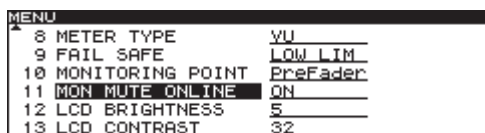

4. Press the **DATA** dial to move the cursor right to select the setting.
5. Turn the **DATA** dial to set whether monitoring output muting during online playback is ON or OFF.
  - Options: OFF, ON (default value)
6. After completing the setting, press the **HOME** button to return to the Home Screen.

#### NOTE

The monitor mute online setting is retained even when the power is turned OFF.

### Importing menu settings

You can import settings that have been saved on a CF card and use them as the unit's menu settings.

Load a CF card containing saved menu settings.

1. Press the **MENU** button to open the MENU screen.
2. Open the **SYSTEM** menu.
3. Select **MENU IMPORT**.

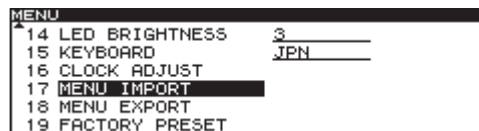

3. Press the **DATA** dial to open a confirmation pop-up message.

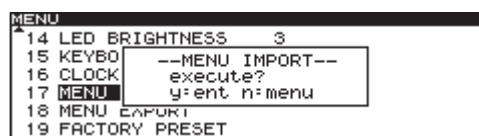

4. Press the **DATA** dial again to import settings from the CF card.
5. When importing completes, the pop-up disappears and the **SYSTEM** menu screen reopens.
6. Press the **HOME** button to return to the Home Screen.

#### NOTE

The LCD CONTRAST, LCD BRIGHTNESS and LED BRIGHTNESS settings of the SYSTEM menu are not imported.

### Exporting menu settings

You can save the unit's MENU screen settings to a CF card.

1. Press the **MENU** button to open the MENU screen.
2. Open the **SYSTEM** menu.
3. Select **MENU EXPORT**.

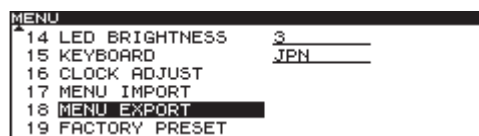

3. Press the **DATA** dial to open a confirmation pop-up message.



4. Press the **DATA** dial again to export the settings to the CF card.
5. When exporting complete, the pop-up disappears and the **SYSTEM** menu screen reopens.
6. Press the **HOME** button to return to the Home Screen.

#### NOTE

The LCD CONTRAST, LCD BRIGHTNESS and LED BRIGHTNESS settings of the SYSTEM menu are not exported.

# 8 – Other settings and information display

## Restoring the factory settings

You can restore all the settings that are stored in the unit's backup memory to the values when shipped from the factory. Follow these steps to restore the settings.

### NOTE

*The factory settings cannot be restored if media is loaded in the current device. Change the current or remove the media from it and conduct the operation again.*

1. Press the **MENU** button to open the **MENU** screen.
2. Open the **SYSTEM** menu.
3. Select **FACTORY PRESET**.

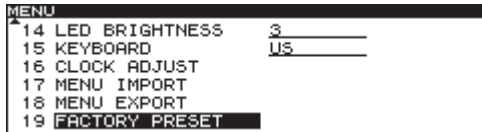

4. Press the **DATA** dial to open a confirmation pop-up message.

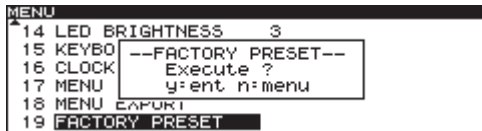

5. Press the **DATA** dial again to restore all settings to their factory defaults. **COMPLETE** appears as a pop-up message when done and the Home Screen automatically reopens.

## Viewing media information

You can view information about the media in the current device. Follow these steps to access this information.

1. Press the **CD/CF** button to select the device containing the media you want to check.  
The indicator above the **CD/CF** button lights.
2. Press the **MENU** button to open the **MENU** screen.
3. Open the **INFORMATION** menu screen.
4. Select **MEDIA INFO**.



5. Press the **DATA** dial to show information about the media in the current device, including its used space and amount of free space.

CD INFORMATION screen example

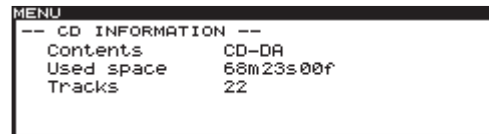

CF INFORMATION screen example

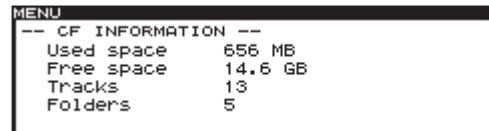

6. When you are finished checking, press the **HOME** button to return to the Home Screen.

## Viewing system information

You can view information about the system. Follow these steps to access this information.

1. Press the **MENU** button to open the **MENU** screen.
2. Open the **INFORMATION** menu screen.
3. Select **SYSTEM INFO**.

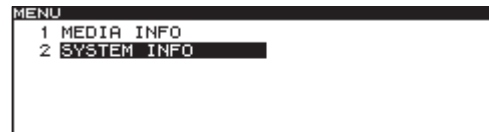

4. Press the **DATA** dial to show the **SYSTEM INFORMATION** screen, where you can check system versions and operating time.

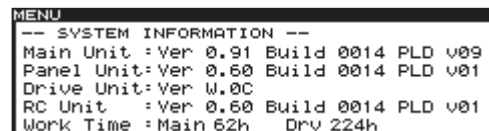

5. When you are finished checking, press the **HOME** button to return to the Home Screen.

# 9 – Operation using a computer keyboard

You can connect a USB computer keyboard to the **KEYBOARD** connector on the rear panel to input text efficiently.

## Setting the keyboard language

Set the keyboard language according to the one you are connecting.

1. Press the **MENU** button to open the **MENU** screen.
2. Open the **SYSTEM** menu.
3. Select **KEYBOARD**.

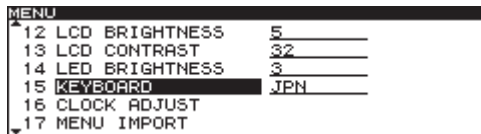

4. Press the **DATA** dial to move the cursor right to select the setting.
5. Turn the **DATA** dial to set the connected keyboard type to **US** (US English-language keyboard) or **JPN** (Japanese-language keyboard).
  - Options: **US**, **JPN** (default value)
6. After completing the setting, press the **HOME** button to return to the Home Screen.

### NOTE

The **KEYBOARD** setting is retained even when the power is turned OFF.

## Using a keyboard to input text

You can edit or enter a folder name or track name in the same manner as when typing text on a computer.

To edit the name of a file or folder, from the **BROWSE** screen, open the **BROWSE MENU** and select **RENAME** to open the **RENAME** screen.

### To select the case

As when using a computer, use the Shift and Caps Lock keys to change the case of characters.

### To input text

Use the number, letter and symbol keys for direct input.

### To move the cursor

Use the keyboard's ↑/↓/←/→ arrow keys.

### To delete a character

Delete key: Deletes the character at the cursor location.

Backspace key: Deletes the character to the left of the cursor location.

### To insert a character

Press the Insert key at the desired location.

### To edit a character

Move the cursor to the character and overwrite it.

### NOTE

- The following symbols and punctuation marks cannot be used in names.

¥/;/; \*?"<>|

- Japanese katakana cannot be used.

# 10 – Using the remote connectors

## Using the serial connector

Using the **REMOTE (SERIAL)** connector (15-pin, D-sub, RS-232C standard), you can control the unit using a TASCAM RC-9010/RC-9010S remote control (sold separately), a computer or other external device.

Use the menu to make communication-related settings.

## Fader use setting

Set whether or not the use of a fader on a TASCAM RC-9010/RC-9010S remote control (sold separately) is enabled.

1. Press the **MENU** button to open the **MENU** screen.
2. Open the **REMOTE** menu screen.
3. Select **FADER MODE**.

MENU		
1	FADER MODE	DISABLE
2	FADER START MODE	DISABLE
3	FADER STOP MODE	DISABLE
4	FADER STOP ACT	STANDBY
5	FADER SCALE	0dB MAX
6	OPERATION PANEL	RC ONLY

4. Press the **DATA** dial to move the cursor right to select the setting.
5. Turn the **DATA** dial to enable or disable fader use.
  - Options: **ENABLE**, **DISABLE** (default value)

### NOTE

When set to **DISABLE**, the internal fader is fixed at 0 dB.

6. After making the setting, press the **HOME** button to return to the Home Screen.

### NOTE

The fader mode setting is retained even when the power is turned OFF.

## Fader start function setting

Fader start allows playback to start by moving the fader of a connected TASCAM RC-9010/RC-9010S remote control (sold separately) from ∞ when the unit is in playback standby.

Enable or disable this function when fader starting is also enabled on the remote.

1. Press the **MENU** button to open the **MENU** screen.
2. Open the **REMOTE** menu screen.
3. Select **FADER START MODE**.

MENU		
1	FADER MODE	DISABLE
2	FADER START MODE	DISABLE
3	FADER STOP MODE	DISABLE
4	FADER STOP ACT	STANDBY
5	FADER SCALE	0dB MAX
6	OPERATION PANEL	RC ONLY

4. Press the **DATA** dial to move the cursor right to select the setting.
5. Turn the **DATA** dial to set enable or disable the fader start function.
  - Options: **ENABLE**, **DISABLE** (default value)
6. After completing the setting, press the **HOME** button to return to the Home Screen.

### NOTE

The fader start mode setting is retained even when the power is turned OFF.

## Fader stop function setting

The fader stop function that allows playback to be stopped or paused (playback standby) by moving the fader of a connected TASCAM RC-9010/RC-9010S remote control (sold separately) to ∞. Set whether or not this function is enabled when fader starting is also enabled on the remote.

### NOTE

If you set both the **FADER START MODE** and **FADER STOP MODE** to **DISABLE**, the fader start function of the TASCAM RC-9010/RC-9010S remote control (sold separately) will be turned OFF automatically, and its **FADER START** button indicator will be unlit. In this state, if you press the **FADER START** button on the remote control, the pop-up message "Can't Change Now, Fixed in crnt mode" appears.

1. Press the **MENU** button to open the **MENU** screen.
2. Open the **REMOTE** menu screen.
3. Select **FADER STOP MODE**.

MENU		
1	FADER MODE	DISABLE
2	FADER START MODE	DISABLE
3	FADER STOP MODE	DISABLE
4	FADER STOP ACT	STANDBY
5	FADER SCALE	0dB MAX
6	OPERATION PANEL	RC ONLY

4. Press the **DATA** dial to move the cursor right to select the setting.
5. Turn the **DATA** dial to enable or disable the fader stop start function.
  - Options: **ENABLE**, **DISABLE** (default value)
6. After completing the setting, press the **HOME** button to return to the Home Screen.

### NOTE

The fader stop mode setting is retained even when the power is turned OFF.



# 10 – Using the remote connectors

## Fader stop action setting

When the fader start function is ON, you can set whether using the fader stop function (lowering the fader to ∞) on a TASCAM RC-9010/RC-9010S remote control (sold separately) causes playback to stop or pause (playback standby).

1. Press the **MENU** button to open the **MENU** screen.
2. Open the **REMOTE** menu screen.
3. Select **FADER STOP ACT.**

MENU	
1 FADER MODE	DISABLE
2 FADER START MODE	DISABLE
3 FADER STOP MODE	DISABLE
4 FADER STOP ACT	STANDBY
5 FADER SCALE	0dB MAX
6 OPERATION PANEL	RC ONLY

4. Press the **DATA** dial to move the cursor right to select the setting.
5. Turn the **DATA** dial to set the action when fader stop occurs.
  - Options: STOP, STANDBY (default value)
6. After completing the setting, press the **HOME** button to return to the Home Screen.

### NOTE

- Depending on the **PLAY** menu screen **MONITOR PLAY STBY** item and **ONLINE PLAY STBY** settings, **BACK CUE** operation might take place.
- The fader stop act setting is retained even when the power is turned OFF.

## Setting the fader scale used

You can set whether to use the scale shown on the left or right side of the fader on a TASCAM RC-9010/RC-9010S remote control (sold separately). The indicator above the active scale lights.

1. Press the **MENU** button to open the **MENU** screen.
2. Open the **REMOTE** menu screen.
3. Select **FADER SCALE.**

MENU	
2 FADER START MODE	DISABLE
3 FADER STOP MODE	DISABLE
4 FADER STOP ACT	STANDBY
5 FADER SCALE	0dB MAX
6 OPERATION PANEL	RC ONLY
7 P.PORT P3/13 ASGN	STANDBY

4. Press the **DATA** dial to move the cursor right to select the setting.
5. Turn the **DATA** dial to set the fader scale used.
  - Options: 10dB MAX (left scale), 0dB MAX (right scale, default value)
6. After completing the setting, press the **HOME** button to return to the Home Screen.

### NOTE

The fader scale setting is retained even when the power is turned OFF.

## Transmission speed setting

You can set the transmission speed (baud rate) used with a TASCAM RC-9010/RC-9010S remote control (sold separately) or other remote control using serial protocol.

### NOTE

The following serial transmission values are fixed: 8 data bits, No parity bit, 1 stop bit.

1. Press the **MENU** button to open the **MENU** screen.
2. Open the **REMOTE** menu screen.
3. Select **SERIAL BAUD RATE.**

MENU	
3 FADER STOP MODE	DISABLE
4 FADER STOP ACT	STANDBY
5 FADER SCALE	0dB MAX
6 OPERATION PANEL	RC ONLY
7 P.PORT P3/13 ASGN	STANDBY
8 SERIAL BAUD RATE	RC

4. Press the **DATA** dial to move the cursor right to select the setting.
5. Turn the **DATA** dial to set the baud rate used to communicate with external remotes.
  - Options: 9600bps, 19200bps, 38400bps, RC (for TASCAM RC-9010/RC-9010S, default value)
6. After completing the setting, press the **HOME** button to return to the Home Screen.

### NOTE

The serial baud rate setting is retained even when the power is turned OFF.

# 10 – Using the remote connectors

## Using the parallel connector

Using the **REMOTE (PARALLEL)** connector, you can control this unit with an external controller.

The pin assignments are as follows.

Pin	Function	IN/OUT
1	ON LINE PLAY IN	IN
2	MONITOR PLAY IN	IN
3	STANDBY IN/PAUSE (JOG ON) IN**	IN
4	STANDBY IN	IN
5	STOP IN	IN
6	TRACK SEARCH REV IN [I◀◀]	IN
7	N.C	-
8	TRACK SEARCH FWD IN [▶▶I]	IN
9	SEARCH REV IN [◀◀]	IN
10	SEARCH FWD IN [▶▶]	IN
11	MONITOR PLAY TALLY	OUT
12	STANDBY TALLY	OUT
13	STANDBY TALLY/ PAUSE (JOG ON) TALLY**	OUT
14	STOP TALLY	OUT
15	INDEX SEARCH REV IN [←]	IN
16	INDEX SEARCH FWD IN [→]	IN
17	ON LINE PLAY TALLY	OUT
18	CUE UP	IN
19	ON LINE IN	IN
20	EOM OUT	OUT
21	FADER START/STOP IN	IN
22	ON LINE TALLY	OUT
23	TEN KEY 0	IN
24	TEN KEY 1	IN
25	TEN KEY 2	IN
26	TEN KEY 3	IN
27	TEN KEY 4	IN
28	TEN KEY 5	IN
29	TEN KEY 6	IN
30	TEN KEY 7	IN
31	TEN KEY 8	IN
32	TEN KEY 9	IN
33	CD_TALLY	OUT
34	CF_TALLY	OUT
35	CUE UP_TALLY	OUT
36	GND	-
37	+5V*	-

**IN:** Active low external command reception (operates when at ground 50 ms or longer)

**OUT:** Signal for tally output display by open collector (50V maximum voltage, 100mA maximum current)

\*100mA maximum supplied current

\*\*Use the P.PORT P3/13 ASGN item on the REMOTE menu screen to set their functions. (See "Parallel port 3-pin/13-pin setting" below.)

The following is an example of a connection for playback control of this unit using fader start/stop.

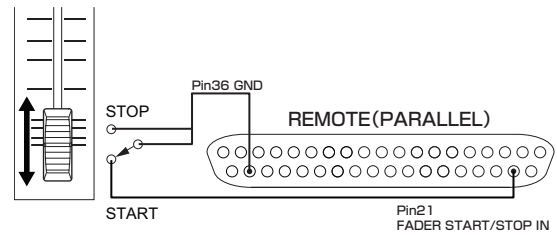

## Parallel port 3-pin/13-pin setting

You can set the functions of the unit's **REMOTE (PARALLEL)** connector 3-pin and 13-pin.

1. Press the **MENU** button to open the MENU screen.
2. Open the **REMOTE** menu screen.
3. Select **P.PORT P3/13 ASGN**.

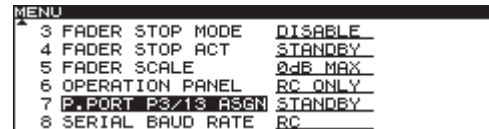

4. Press the **DATA** dial to move the cursor right to select the setting.
5. Turn the **DATA** dial to set the **REMOTE (PARALLEL)** connector 3-pin and 13-pin functions.  
Options: PAUSE, STANDBY (default value)

Pin number	P.PORT P3/13 ASGN setting	
	PAUSE	STANDBY
3	PAUSE (JOG ON) IN	STANDBY IN
13	PAUSE (JOG ON) TALLY	STANDBY TALLY

6. After completing the setting, press the **HOME** button to return to the Home Screen.

### NOTE

The pin assignment setting is retained even when the power is turned OFF.

# 11 – Message list

## Error messages

If one of the following error messages appears in a pop-up, press the **DATA** dial to close the message. Then try to resolve the issue. If the error message continues to appear frequently, please contact the store where you purchased this unit or a TASCAM customer support service.

	1st line	2nd line	Meaning
1	- error -	DECODE	Failed to play WAV file.
2	- error -	MIX DISC	The disc has both WAV format files and audio CD format files on it.
3	- error -	MEMORY READ	Ripping cannot be executed because media is not loaded in the selected device.
4	- error -	TRACK	Playback is not possible because the file on the CD is of an unplayable format.
5	- error -	CF WRITE	Failed to write to the CF card.

## Warning messages

When an operation cannot be conducted, one of the following pop-up warning messages will appear on the display. After appearing for about two seconds, warning messages automatically disappear.

	1st line	2nd line	Meaning
1	- caution -	MEDIA FULL	Ripping is not possible because the media does not have enough open space.
2	- caution -	TRACK FULL	Ripping is not possible because the maximum number of tracks (999) has been reached.
3	- caution -	NOT EXECUTE	Failed to execute the editing operation.
4	- caution -	CAN'T EDIT	Editing was not possible due to system limitations.
5	- caution -	CAN'T SELECT	Selection/execution was not possible due to system limitations.
6	- caution -	TRK PROTECT	Editing was not possible because the track is protected.
7	- caution -	NAME FULL	The maximum number of characters for the name (text field) has been reached.
8	- caution -	PROGRAM FULL	The track cannot be added because the maximum number of tracks in a program has been reached.
9	- caution -	SAME NAME	An item with the same name already exists.

## Operation messages

As necessary, the following messages will appear in the time display area.

	1st line	Meaning
1	CLOSE	The disc tray is closed.
2	DEVICE ERROR	The device cannot be detected. Please contact TASCAM customer support.
3	MEDIA ERROR	The media is not playback media.
4	MEDIA READING	Now reading from media.
5	NO MEDIA	Media is not loaded in the current device.
6	OPEN	The disc tray is open.
7	POWER ON	The system is starting up and initializing.
8	RIPPING	The CD contents are being converted and copied to the CF card.
9	UNKNOWN	The media is in a format other than FAT. Format the media with the unit in order to use them together. The disc is an incompatible format (DVD, non-hybrid SACD, etc.). Use an audio CD, or data CD with WAV files.

# 12 – Troubleshooting

If the unit is not functioning properly, please check the following items before calling for service. If these measures do not solve the problem, please contact the store where you purchased this unit or TEAC customer support service (see the back cover).

## ■ Power does not turn on

Confirm that the power plug is inserted completely.

## ■ Media is not detected

Confirm that the CD or CF media is loaded properly. Stop playback or recording once.

## ■ Unit cannot be controlled

Confirm that the panel lock function is not on.

## ■ Unable to playback a file

If it is a WAV file, confirm that it uses a sampling frequency (44.1 kHz or 48 kHz) and a bit rate (16 or 24) that are supported by this unit.

## ■ No sound

Confirm the connections with the monitoring system and check the volume of the amplifier.

## ■ Changed settings are not saved

This unit backs up settings whenever you change them. This backup could fail if you turn off the power while this data is being written, so do not turn the power off immediately after changing a setting.

## ■ I hear noise

Check if any connecting cable might have a bad connection.

## ■ When editing text, "Name Full" appears

Due to limitations of the system, folder names can be a maximum of 52 characters (single-byte) long. A full path on the **BROWSE** screen cannot exceed 255 characters. For example, for a file or folder within a subfolder, the maximum number of characters is 255, including folders above it and all separators.

---

## Media and file formats

---

### Supported media

CF card (512MB – 32GB, Type I only)  
CD, CD-R (CD-DA audio discs, ISO9660 Level1/Joliet/Romeo data discs)

### Playback file formats

WAV: 44.1/48kHz, 16/24-bit, Maximum file size 2GB  
CD-DA: 44.1kHz, 16-bit

### Number of channels

2 (stereo)  
1 (mono)

---

## Inputs and outputs

---

### Analog audio inputs and outputs

#### MIX INPUTS (BALANCED)

Connector: XLR-3-31 (1: GND, 2: HOT, 3: COLD)  
Input impedance: 10 k $\Omega$   
Nominal input level: +4 dBu (1.23 Vrms)  
Maximum input level: +24 dBu (12.28 Vrms)

#### LINE OUTPUTS (BALANCED)

Connector: XLR-3-32 (1: GND, 2: HOT, 3: COLD)  
Output impedance: 200  $\Omega$   
Nominal output level: +4 dBu (1.23 Vrms)  
Maximum output level: +24 dBu (12.28 Vrms)

#### MONITOR OUTPUTS (BALANCED)

Connector: XLR-3-32 (1: GND, 2: HOT, 3: COLD)  
Output impedance: 200  $\Omega$   
Nominal output level: +4 dBu (1.23 Vrms)  
Maximum output level: +24 dBu (12.28 Vrms)

#### PHONES

Connector: 6.3mm (1/4") standard stereo jack  
Maximum output level: 45 mW+45 mW  
(THD+N 0.1%, 32  $\Omega$ )

---

## Digital audio output

#### DIGITAL OUT

Connector: BNC  
Format: AES3-2003/AES-3id-2001/IEC60958-4 (AES/EBU)  
Output impedance: 75  $\Omega$

---

## Control inputs and outputs

#### WORD IN

Connector: BNC  
Input voltage: 5V TTL equivalent  
Input impedance: 75  $\Omega$   
Permissible frequency variation during external synchronization:  $\pm$ 100 ppm  
Switchable clock terminator

#### WORD THRU

Connector: BNC  
Output voltage: 5V TTL equivalent  
Output impedance: 75  $\Omega$

#### REMOTE IN (SERIAL)

Connector: D-sub 15-pin

#### REMOTE IN (PARALLEL)

Connector: D-sub 37-pin  
Maximum input voltage: +5.5 V  
High-level minimum input voltage: +3.75 V  
Low-level maximum input voltage: +1.25 V  
Output format: open drain (withstand voltage 50 V, maximum 100 mA)  
Low-level maximum output voltage: 0.5 V  
+5V power maximum supplied current: 100 mA

#### KEYBOARD

Connector: USB A-type 4-pin  
Protocol: USB 1.1 Low Speed (1.5 Mbps)  
+5V power maximum supplied current: 500 mA

---

## Audio performance

---

#### Frequency response

20 Hz–20 kHz:  $\pm$ 0.5 dB

#### Distortion

0.005% or less

#### S/N ratio

100 dB or more

#### Dynamic range

95 dB or more

#### Channel separation

95 dB or more

#### NOTE

*All audio performance ratings are for playback according to JEITA CP-2150 standards*

# 13 – Specifications

## Backup memory

The following settings are backed up even when the power is turned OFF.

- Playback mode settings
- Program playback settings
- Cue playback settings (for up to 500 CDs)
- Menu item settings: auto cue, auto ready, incremental playback, online back cue, play key function, monitor playback standby, online playback standby, repeat playback, EOM, end check, pitch control value, external remote, jog playback, RS-232C, digital output, analog output, online, master clock, mono mix playback, level meter display, fail safe, monitoring point, online monitor muting, display and indicator brightness, display contrast, keyboard type

## General

### Power

AC 100-240 V, 50-60 Hz

### Power consumption

18 W

### Dimensions (width × height × depth)

220 x 136.8 x 385.2 mm

### Weight

6 kg

### Operating temperature range

5–35° C (41–95° F)

### Installation angle

5° or less

## Dimensional drawings

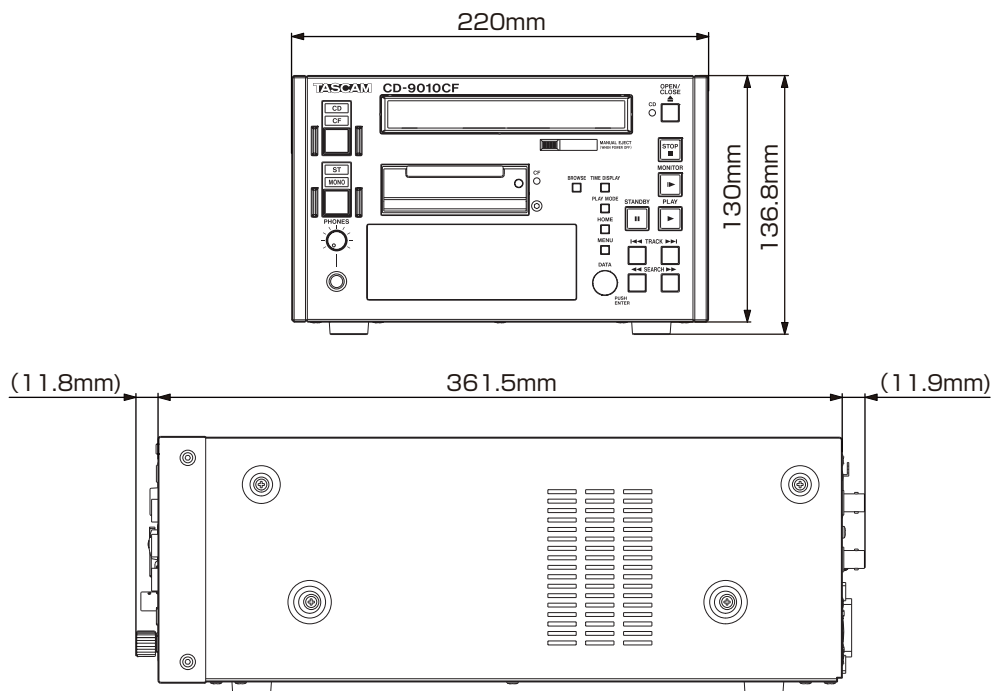



# TASCAM

# CD-9010CF

## TEAC CORPORATION

Phone: +81-42-356-9143

1-47 Ochiai, Tama-shi, Tokyo 206-8530 Japan

<https://tascam.jp/jp/>

---

## TEAC AMERICA, INC.

Phone: +1-323-726-0303

1834 Gage Road, Montebello, California 90640 USA

<http://tascam.com/>

---

## TEAC MEXICO, S.A. de C.V.

Phone: +52-55-5010-6000

Río Churubusco 364, Colonia Del Carmen, Delegación Coyoacán, CP 04100, México DF, México

<http://teacmexico.net/>

---

## TEAC UK LIMITED

Phone: +44-8451-302511

2 Huxley Road, Surrey Research Park, Guildford, GU2 7RE, United Kingdom

<http://tascam.eu/>

---

## TEAC EUROPE GmbH

Phone: +49-611-71580

Bahnstrasse 12, 65205 Wiesbaden-Erbenheim, Germany

<http://tascam.eu/>

---

## TEAC SALES & TRADING(SHENZHEN) CO., LTD

Phone: ++86-755-88311561~2

Room 817, Block A, Hailrun Complex, 6021 Shennan Blvd., Futian District, Shenzhen 518040, China

<http://tascam.cn/>