

**4U Rackmount
DVD/CD Duplicator
User's Manual**

Models:

TASCAM DV-W14R

TASCAM[®]

Safety Precautions

Rackmount DVD/CD Duplicators are high-precision electronic devices. Do not use them in any manner other than as specified in this manual. Please read this manual in its entirety before you begin the installation procedure. Use of controls, adjustments, or performance of procedures other than those specified herein may result in hazardous laser exposure.

To prevent fire or shock, do not expose the unit to moisture or rain.

To prevent electrical shock, do not attempt to disassemble the DVD/CD Duplicator. Refer servicing to authorized personnel.

Rackmount DVD/CD Duplicators drives utilize a laser beam that can be harmful to your eyes. Do not disassemble the cabinet or unit. Do not attempt to look through the front panel or into the unit while the power is turned on.

Elevated Operating Ambient: If the unit is installed in a closed or multi-unit rack assembly, the operating ambient temperature of the rack environment may be greater than the room ambient temperature. Therefore, consideration should be given to installing the equipment in an environment compatible with the maximum ambient temperature (T_{ma}) specified by the manufacturer.

Reduced Air Flow: Installation of the equipment in a rack should be such that the amount of air flow required for safe operation of the equipment is not compromised.

Mechanical Loading: Mounting of the equipment in the rack should be such that a hazardous condition is not achieved due to uneven mechanical loading.

Circuit Overloading: Consideration should be given to the connection of the equipment to the supply circuit and the effect that overloading of the circuits might have on over-current protection and supply wiring. Appropriate consideration of equipment nameplate ratings should be used when addressing this concern.

Reliable Earthing: Reliable earthing of rack-mounted equipment should be maintained. Particular attention should be given to supply connections other than direct connections to the branch circuit (e.g. use of power strips).

A user who changes or modifies the unit or operating procedures specified herein without expressed written approval from the manufacturer will void user authority to operate the equipment.

Specifications and features subject to change without notice or obligation.

Copyright and Trademark Information

© Copyright 2008 TEAC America, Inc. All rights reserved.

TEAC America, Inc. reserves the right to modify product offerings or specifications without advanced notice. No part of this publication may be reproduced in any format without the expressed written permission of TEAC America, Inc.

TEAC and TASCAM are trademarks of TEAC Corporation. All other trademarks and registered trademarks are the property of their respective owners.

Piracy Statement

Copying or duplicating copyrighted materials—including audio compact discs (CDs) and DVD movies—without the permission of the copyright holder constitutes theft of intellectual property. It is a serious crime and a violation of Federal law.

Do not use the TEAC or TASCAM Rackmount DVD/CD Duplicator (or any equipment) to copy or duplicate copyrighted digital audio, video, photographs, images, text, software or other digital information without the permission of the copyright holder.

TEAC and TASCAM accept no responsibility for copyright infringement or misuse of this equipment. It is the sole responsibility of the user to use the equipment within the limits prescribed by law and to respect the legal copyrights of all copyright owners.

FCC Radio Frequency Interference Regulations

Warning: This equipment generates, uses, and can radiate radio frequency energy and if not installed and used in accordance with the instructions contained in this manual, may cause harmful interference to radio and television communications. This equipment has been tested and found to comply with the limits for a Class B digital device pursuant to Subpart B of Part 15 of the FCC Rules. These limits are designed to provide reasonable protection against harmful interference in a residential installation. However, there is no guarantee that interference will not occur in a particular installation.

If this equipment does cause harmful interference to radio or television reception (which can be determined by turning the equipment off and on), the user may try to correct the interference by one or more of the following measures:

- Reorient or relocate the receiving antenna.
- Move the device and the receiver further apart.
- Connect the equipment to an electrical outlet on a different circuit than the receiver.
- Consult the dealer or an experienced audio television technician.

Also, the following booklet may prove helpful: *How to Identify and Resolve Radio-TV Interference Problems*. It is available from the U.S. Government Printing Office, Washington, D.C. 20402, stock number 004-000-00345-4.

The user is cautioned that any changes or modifications not expressly approved by TEAC America, Inc. could void the user's warranty.

Table of Contents

Safety Precautions	i
Copyright and Trademark Information	i
Piracy Statement	ii
FCC Radio Frequency Interference Regulations	ii
List of Figures	v
About This Manual	v
Chapter 1. Introduction	1
Rackmount DVD/CD Duplicator Package Contents	2
Front Panel	3
Rear Panel	5
Chapter 2. Using the Rackmount DVD/CD Duplicator	7
Setup	7
Basic Operation	9
1x4 Mode: Copying from the Optical Source Drive	9
1x5 Mode: Copying from the Internal Hard Disk Drive	11
Chapter 3. Rackmount DVD/CD Duplicator Functions	15
1 Copy	15
2 Test	15
3 Test & Copy	15
4 Verify	15
5 Compare	16
6 Prescan	16
7 Disc Info	16
8 Select Source	16
Selecting 1x4 Mode (one source and four target drives)	16
Selecting 1x5 Mode (one source and five target drives)	17
9 Image	18
9.1 Load	18
9.2 Delete Image	18
9.3 Image Info	18
9.4 Compare Image	18
9.5 Select Image	18
9.6 Image Src Drive	19
9.7 Image Format Info	19
10. Edit Track (for CD only)	19
10.1 CD to CD Edit	19
10.2 CD to HDD	23
10.3 Play Audio Track	23
10.4 Close Session	24
11 Setup	24
11.1 Language	24
11.2 CD Burn Speed	24
11.3 DVD Burn Speed	24
11.4 Read Speed	24

11.5 Auto Start Drive	24
11.6 Startup Menu	25
11.7 Auto Verify	25
11.8 Auto Compare	25
11.9 Auto Prescan	25
11.10 Eject Disc	25
11.11 Burn on the Fly	25
11.12 Burn Mode	26
11.13 Display Time	26
11.14 Button Sound	26
11.15 Device Info	26
11.16 System Info	26
11.17 Quick Erase	26
11.18 Full Erase	26
11.19 Auto Close Tray	26
11.20 Quick Compare	27
11.21 Audio Burn Speed	27
12 Advanced Setup (Adv Setup)	27
12.1 UnderRun Protect	27
12.2 Overburn	27
12.3 Read Error Skip	28
12.4 Format HDD	28
12.5 Verify HDD	28
12.6 Burn-in	28
12.7 Update Firmware	28
12.8 Compare Firmware	29
12.9 H/W Diagnostic	29
12.10 Load Default	29
12.11 CD+G	30
12.12 ISRC & MCN	30
12.13 USB Option	30
12.14 CD-Text	30
Appendix A. List of Functions	31
Appendix B. LCD Messages	32
Normal Conditions	32
Audio Editing	33
Appendix C. Frequently Asked Questions (FAQ)	34
FAQ	35
Appendix D. About DVD±R and DVD±RW Discs	37
Handling Discs	37
Loading and Ejecting Discs	38
Appendix E. Specifications	39
Appendix F. Technical Support	40

List of Figures

Figure 1. Rackmount DVD/CD Duplicator Package Contents	2
Figure 2. Front Panel of Rackmount DVD/CD Duplicator	3
Figure 3. LCD Control Panel	3
Figure 4. Rear Panel of the Rackmount DVD/CD Duplicator	5
Figure 5. Installing the DVD/CD Duplicator in a Rack	7
Figure 6. Copy Function on LCD Panel	8
Figure 7. How to Handle Compact Discs (including DVD±R and DVD±RW)	37
Figure 8. Ejecting the Disc Tray	38

About This Manual

This *4U Rackmount DVD/CD Duplicator User's Manual* explains how to operate the Rackmount DVD/CD Duplicator. It is divided into the following chapters:

Chapter 1: Introduction

This chapter describes the shipping package contents and introduces the Rackmount DVD/CD Duplicator.

Chapter 2: Using the Rackmount DVD/CD Duplicator

This chapter explains how to set up the Rackmount DVD/CD Duplicator. It also describes a basic copy operation.

Chapter 3: Rackmount DVD/CD Duplicator Functions

This chapter explains all available functions of the Rackmount DVD/CD Duplicator.

Appendix A: List of Functions

Appendix A includes a complete list of all Rackmount DVD/CD Duplicator functions.

Appendix B: LCD Messages

Appendix B lists all messages that may appear on the LCD display.

Appendix C: Frequently Asked Questions (FAQ)

Appendix C can help you to resolve technical difficulties that you might encounter.

Appendix D: About DVD±R and DVD±RW Discs

Appendix D contains information about handling, loading, and ejecting discs.

Appendix E: Specifications

Appendix E includes technical specifications for the Rackmount DVD/CD Duplicator.

Appendix F: Technical Support

Appendix F explains how to contact technical support for your Rackmount DVD/CD Duplicator.

Chapter 1. Introduction

Thank you for purchasing a TEAC or TASCAM 4U Rackmount DVD/CD Duplicator.

Note: *This User's Manual is intended for both TEAC and TASCAM branded Rackmount DVD/CD Duplicators. Operational instructions for both models are essentially the same. The primary differences between the models are the TEAC or TASCAM logo on the LCD control panel and the name plate on the rear panel.*

The Rackmount DVD/CD Duplicator is a stand-alone disc-to-disc DVD/CD Duplicator system that does not require connection to a computer. It can duplicate a single master DVD±R to DVD±R media at up to 20X speeds, resulting in an exact replica of a 4.7GB disc. It can duplicate discs to CD-R/CD-RW media at up to 48X/32X speeds respectively. It can also duplicate discs to DVD±R DL media.

The Rackmount DVD/CD Duplicator is designed to perform DVD and CD copying quickly and accurately. The Rackmount DVD/CD Duplicator automatically identifies source DVD formats and replicates the content as required.

The Rackmount DVD/CD Duplicator performs continuous copying with no waiting. It is an ideal DVD/CD Duplicator for the advanced user who requires speed and accuracy.

You can set up your Rackmount DVD/CD Duplicator very quickly and easily. There is no need to install any software. There is no need to attach any cables to your computer. The Rackmount DVD/CD Duplicator functions entirely as a stand-alone unit.

Caution: *Your Rackmount DVD/CD Duplicator can operate on either 115VAC or 220VAC voltage. Before you turn on the power to the unit, be certain to select the correct voltage for your region by setting the AC Voltage Selector on the rear panel. Failure to do so can result in damage to the unit. For more information, refer to page 5.*

Rackmount DVD/CD Duplicator Package Contents

Your Rackmount DVD/CD Duplicator package includes the following items (see Figure 1).

- TEAC or TASCAM Rackmount DVD/CD Duplicator unit
- AC power cable
- Rackmount DVD/CD Duplicator System User's Manual* (this booklet)
- Warranty card (not shown)
- Optional rubber feet (not shown)

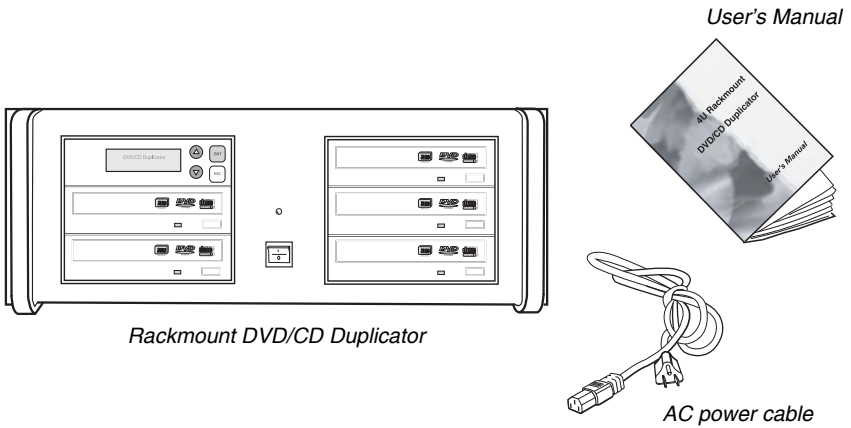

Figure 1. Rackmount DVD/CD Duplicator Package Contents

Note: *If any of the items above is missing from your package upon purchase, please contact your vendor immediately.*

Front Panel

Figure 2 illustrates the front panel of the Rackmount DVD/CD Duplicator.

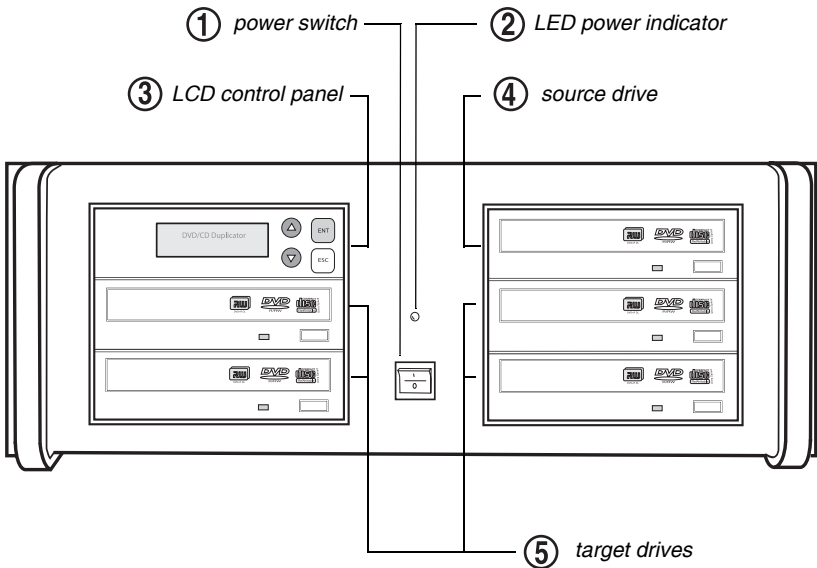

Figure 2. Front Panel of Rackmount DVD/CD Duplicator

- ① **power switch:** Use the power switch to turn the power to the DVD/CD Duplicator unit on or off.
- ② **LED power indicator:** The LED power indicator will be continuously lit when the DVD/CD Duplicator power is on.
- ③ **LCD control panel:** Use the control panel buttons to navigate through the various functions viewed on the LCD display.

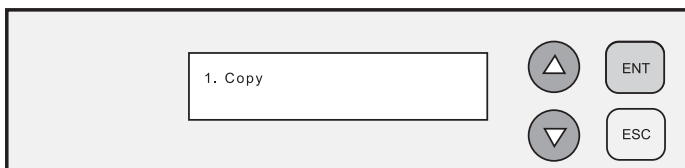





Figure 3. LCD Control Panel

The DVD/CD Duplicator control panel features an LCD display and four buttons. These buttons are described in the following table:

	Press the Up arrow button to scroll up functions or menus.
	Press the Down arrow button to scroll down functions or menus.
	Press the ENT (Enter) button to execute a selected function.
	Press the ESC (Escape) button to cancel a selected function or to return to the main menu.

- ④ **source drive:** This drive is the source drive when the DVD/CD Duplicator is being used in 1x4 mode (one source drive and four target drives). In 1x5 mode (one source drive and five target drives), this drive serves as an additional target drive and the internal hard disk drive functions as the source drive. (Refer to Chapter 2 “Using the Rackmount DVD/CD Duplicator” on page 7 for more details.)

Insert the disc to be copied into the source drive. Use the disc tray to load a DVD or CD into the drive. You can open the tray by pressing the Load/Eject button (if the tray fails to open, you can use the emergency eject mechanism). You can close the tray by pressing the Load/Eject button.

***Note:** It is strongly recommended that you do not push the tray in to close it. Please press the Load/Eject button to eject or retract the tray. See Figure 8 on page 38.*

- ⑤ **target drives:** In 1x4 mode, there is one (1) source drive and four (4) target drives. In 1x5 mode, there is one (1) source drive and five (5) target drives. (Refer to Chapter 2 “Using the Rackmount DVD/CD Duplicator” on page 7 for more details.)

Insert a blank disc into each target drive to make a copy of the source disc. You can open the tray by pressing the Load/Eject button (if the tray fails to open, you can use the emergency eject mechanism). You can close the tray by pressing the Load/Eject button.

***Note:** It is strongly recommended that you do not push the tray in to close it. Please press the Load/Eject button to eject or retract the tray. See Figure 8 on page 38.*

Rear Panel

Figure 4 illustrates the rear panel of the Rackmount DVD/CD Duplicator.

The unit features an AC Power In connector, an AC voltage selector and cooling fans.

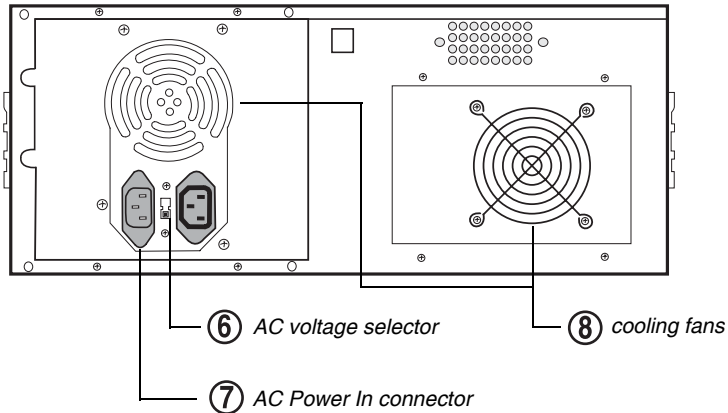

Figure 4. Rear Panel of the Rackmount DVD/CD Duplicator

- ⑥ **AC voltage selector:** Use this switch to select either 115VAC or 220VAC.

Caution: Before you turn on the power to the Rackmount DVD/CD Duplicator, make sure the correct voltage is selected. Otherwise, you risk damage to the unit. The default setting is 115VAC.

- ⑦ **AC Power In connector:** Connect the included AC power cable to this input connector. Plug the other end of the power cable into a three-prong receptacle AC power outlet.

Caution: Do not attempt to bypass the grounding plug. Otherwise, you risk electrical shock or damage to the unit.

Note: To ensure proper operation, use only the original AC power cable with your DVD/CD Duplicator.

- ⑧ **cooling fan:** Ball-bearing fans cool the Rackmount DVD/CD Duplicator.

Chapter 2. Using the Rackmount DVD/CD Duplicator

This chapter explains how to set up the Rackmount DVD/CD Duplicator. It also explains basic operation and menu functions.

Note: The following instructions are applicable to TEAC and TASCAM branded Rackmount DVD/CD Duplicators. The primary differences between models are the TEAC or TASCAM logo on the LCD Control Panel and the model number on the corresponding nameplate label. Please refer to “Specifications” on page 39 for detailed information on your model.

Setup

1. Carefully remove the DVD/CD Duplicator unit, AC power cord, warranty card, optional rubber feet and user’s manual from the shipping box.

Note: Please keep the original box and packaging materials for use in the event of future storage or transportation of the unit.

2. If the unit will not be mounted onto a rack, you may wish to affix the four included rubber feet to the bottom of the Rackmount DVD/CD Duplicator. Then skip Step 3 and proceed directly to Step 4.
3. To rack mount the DVD/CD Duplicator, leave a 1U of space above it and 4 inches (10cm) or more of space at the rear. Use a rack-mounting kit (not included) to mount the unit in a standard 19-inch equipment rack, as illustrated below. If rubber feet are currently affixed to the bottom of the unit, remove the rubber feet before you attempt to mount the unit in a rack.

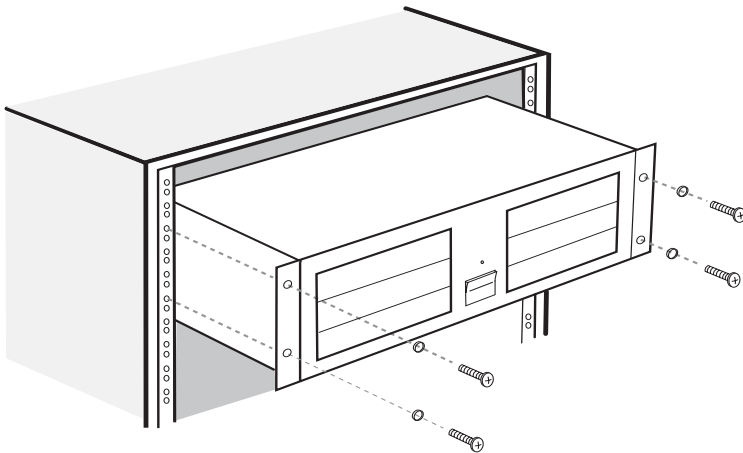

Figure 5. Installing the DVD/CD Duplicator in a Rack

4. Connect one end of the included power cable to the back of the DVD/CD Duplicator. Connect the other end of the power cable to a three-prong receptacle AC outlet.

Caution: Do not attempt to bypass the grounding plug. Otherwise, you risk damage to the unit and electrical shock.

5. Turn on the power to the DVD/CD Duplicator by pressing the power button on the lower front-center of the unit.

During initialization, the DVD/CD Duplicator performs a self-test in which the unit's internal buffer is tested, source and target drives are detected, and the LCD display is tested. Once the initialization is complete, the DVD/CD Duplicator is ready for use.

The LCD initially displays the Copy function by default.

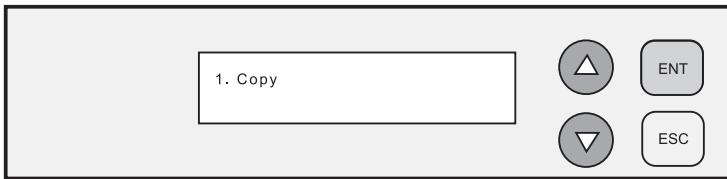

Figure 6. Copy Function on LCD Panel

Basic Operation

The Rackmount DVD/CD Duplicator offers two modes of operation:

- ❑ 1x4 mode (one source optical drive and four target optical drives)
- ❑ 1x5 mode (one source hard disk drive and five target optical drives)

The 1x4 mode of operation is the factory default setting.

You can switch from 1x4 to 1x5 mode of operation (and vice-versa) by changing the source drive setting using menu option 8, the Select Source function (for more information, see section “8 Select Source” on page 16).



This section explains these two modes of operation for the Rackmount DVD/CD Duplicator.

1x4 Mode: Copying from the Optical Source Drive

This is the factory default mode of operation. You can start copying DVD/CD discs by following the instructions below.

1. Place your DVD/CD source disc in the disc tray of the source drive.

The source drive is located in the upper-right corner of the unit. (Refer to Figure 2 on page 3.)

2. Switch to function [1 Copy] by pressing the  /  buttons (if necessary).

Refer to Figure 6 on page 8.

3. Place a blank DVD/CD disc into as many of the target drives as you desire, then press the  (ENT) button to start copying.

Note: The type and capacity of the target disc(s) must match that of the source disc. For example, if the source disc is a CD-ROM, then the blank target disc(s) must be CD-R disc(s). If the source disc is a 4.7GB DVD-ROM disc, then the blank target disc(s) must be 4.7GB DVD±R. If the source disc is an 8.5GB Dual Layer (DL) disc, then the blank target disc(s) must be 8.5GB DVD±R DL.

You do not need to insert a DVD disc into every available target drive. You can make fewer copies if you prefer. The internal controller will automatically detect inserted discs and issue the record command to only those target drives that contain a blank disc.

When the copy operation is complete, the DVD/CD disc in each of the target drives will be ejected automatically.

Notes:

- ❑ *With the default setting, after a source disc has been successfully copied, the DVD/CD Duplicator automatically ejects the target DVD/CD discs.*
- ❑ *With the default setting, if the copy operation fails, the failed target DVD/CD disc remains in the target drive. To remove the failed DVD/CD disc, press the eject button on the target drive and retrieve the disc. Press the eject button again to retract the disc tray. You can change the default settings by using the [Advanced Setup] menu. (For more information, see “12 Advanced Setup (Adv Setup)” on page 27.)*

1x5 Mode: Copying from the Internal Hard Disk Drive

In this mode of operation, you can copy from the internal hard disk drive to up to five (5) optical target drives. The following procedure explains how to use the DVD/CD Duplicator in 1x5 duplication mode.

During initialization (see Step 3 on page 8), the DVD/CD Duplicator performs a self-test to detect source drives. The upper-right DVD-RW drive and the hard disk drive will be detected as available source drives. The upper-right DVD-RW drive is the default source drive.



The internal hard disk drive was formatted and partitioned at the factory. Each partition occupies 5GB of hard disk space. The number of partitions depends on the capacity of the hard disk drive. Partitions are arranged alphabetically and initially contain no data. A set of data loaded into a partition on the hard disk drive is called an “image file.”

To use the hard disk drive as the source drive in 1x5 mode, you must first load an image file from a DVD onto a partition on the hard disk drive, select the partition that contains the data you want to copy, specify the hard disk drive as the source drive, then execute the copy function.



1. Insert a source DVD into the source drive.

This disc (DVD-ROM or DVD) contains the data that you wish to copy to the partition on the internal hard disk drive.

Selecting a Partition (to which you will copy data)

2. Press the  /  buttons to select function menu [9 Image], then press the  (ENT) button.

The Image menu includes the Load, Delete Image, Image Info, Compare Image, Select Image, Image Src Drive and ImageFormat Info functions.



3. Press the  /  buttons to select function [9-5 Select Image], then press the  (ENT) button to access the Select a Partition submenu.

The Select a Partition submenu enables you to select a partition (A, B, C, etc.) into which to load an image file on the hard disk drive. (When the unit is shipped from the factory, the partitions on the hard disk drive contain no data.)

The LCD will display a message similar to the following for each corresponding partition:

Select a Partition

No image in A

4. Press the  /  buttons to select the desired partition letter.

The LCD will display partition A as the first option, but you can select any partition letter at any time.





5. Press the  (ENT) button to confirm the desired partition.

The LCD will display a message similar to the following:

Set Partition To A

(If you selected partition B, the LCD will display the message:
Set Partition To B, and so on.)

Loading Data to the Selected Partition

6. Press the  (ESC) button to return to function menu [9 Image].
7. Press the  /  buttons to select function [9-1 Load], then press the  (ENT) button to transfer data from the DVD to the specified partition on the hard disk drive.

The data (image file) on the DVD in the source drive will be copied onto the partition you selected in Step 5.



Note: *To help you quickly locate your data in the future, it is recommended that you keep track of the data that you load into each partition.*

8. Once the data is loaded successfully, remove the source disc from the optical drive.
9. Repeat Steps 1 through 8 to load additional image files from other DVDs to other partitions, if desired.



At this point, the selected partition is the same as the one you selected in Step 5 above. If you want to copy from this partition, skip to Step 12.

If you want to copy an image file from another partition into which you have already loaded data, continue with Step 10.

Selecting a Partition (from which data will be copied to discs)

10. Press the  /  buttons to select function [9-5 Select Image], then press the  (ENT) button to access the Select a Partition submenu.



The Select a Partition submenu also enables you to select a partition (A, B, C, etc.) from which you want to copy an image file.

11. Press the  /  buttons to select the partition you wish to copy from, then press the  (ENT) button.

The data will be copied from the selected partition when you specify the hard disk drive as the source and execute the copy function as described in Steps 13 through 16.



12. Press the  (ESC) button twice to exit to the DVD/CD Duplicator's main menu.

Selecting a Source Drive

13. Press the  /  buttons to select the [8 Select Source] function.

The LCD displays the following message:

8. Select Source

14. Press the  (ENT) button, then press the  /  buttons to select the DVD Writer source, as shown below.

Src: HDD
01 IDE1 Master

15. Press the  (ENT) button.



The LCD displays the following message:

HDD Selected!

The hard disk drive is now designated as the source drive.

16. Press the  (ESC) button to go back to the main menu.

Copying Data from the Hard Drive to Target Discs

17. Press the  /  buttons to switch to function [1 Copy].

The LCD will display a message similar to the following:

1 Copy. P: A

This message indicates that the data will be copied from the hard disk drive's partition "A" (which was selected in Step 11).

(If you selected partition B, the LCD will display the message:
“1 Copy. P: B,” and so on.)

18. Place a blank DVD±R disc into each of the target drives, then press the



(ENT) button to start copying.

Notes:

- ❑ *With the default setting, after source data has been successfully copied to the target DVD discs, the DVD/CD Duplicator automatically ejects the discs.*
- ❑ *With the default setting, if the copy operation fails, the failed target DVD disc remains in the target drive. To remove the failed DVD disc, press the eject button on the target drive and retrieve the disc. Then press the eject button again to retract the disc tray. You can change the default settings by using the [Advanced Setup] menu. (See “12 Advanced Setup (Adv Setup)” on page 27.)*

Chapter 3. Rackmount DVD/CD Duplicator Functions

The DVD/CD Duplicator features 12 functions: Copy, Test, Test & Copy, Verify, Compare, Prescan, Disc Info, Select Source, Image, Edit Track, Setup, and Advanced Setup. Each function is explained below.

1 Copy

The Copy function enables you to copy data from a source DVD or CD disc or a partition on the internal hard disk drive. For more detailed information, refer to “Basic Operation” on page 9.

Note: You can use DVD±RW discs that already contain data (i.e., DVD±RW discs that are not fully blank) as target discs. However, the data stored on the DVD±RW disc will be erased automatically before the new data is copied. No special setting or procedure is required to erase the old data.

2 Test

The Test function simulates writing to the target disc. Discs will remain blank after the test is complete. This function is recommended if you are using unsupported media. This function enables the target drive to adjust its laser to the proper intensity.

Note: Unexpected termination or cancellation of a test will not affect a target DVD±R disc. The target DVD±R disc will remain blank and available for use. However, DVD±RW discs that contain data may be damaged and the data they contained may be rendered unrecoverable. It may be necessary to re-start the DVD/CD Duplicator if the target drive hangs during a sudden termination.

3 Test & Copy

The Test & Copy function performs the test simulation and the copy process in one step.

The copy process is performed only if the simulation detects no problems. If the simulation fails, the copy process is cancelled.

4 Verify

The Verify function verifies that the target disc was written completely and with no errors.

5 Compare

The Compare function compares data on the source and target discs after the copy process is complete.

Note: This function works only with data discs.

6 Prescan

The Prescan function is performed on the source drive. This function scans the disc to determine the maximum data/audio extraction speed.

7 Disc Info

The Disc Info function displays detailed information about the source disc, including sessions, tracks, capacity, etc.



8 Select Source

The Select Source function enables you to select a drive (DVD Writer or hard disk drive) as the source from which to copy.

If you select the DVD Writer as the source, the unit will work as a 1x4 DVD/CD Duplicator (one source optical drive and four target optical drives).



If you select the internal hard disk drive, the unit will work as a 1x5 DVD/CD Duplicator (one source hard disk drive and five target optical drives).

Selecting 1x4 Mode (one source and four target drives)

1. Press the  /  buttons to select the [8 Select Source] function.

The LCD displays the following message:

8. Select Source

2. Press the  (ENT) button, then press the  /  buttons to select the DVD Writer source, as shown below.



Src: Super Multi
00 IDE0 Master

Be sure to select drive 00 IDE0. (This is the drive in the upper-right corner of the unit.)

3. Press the  (ENT) button.

The LCD displays the following message:

S-Multi Selected



4. Press the  (ESC) button to return to the main menu, then press the  /  buttons to select the [1. COPY] function.

The LCD displays the following message:

1. COPY



Please refer to Chapter 2, “Using the Rackmount DVD/CD Duplicator” on page 7 for more information.

Selecting 1x5 Mode (one source and five target drives)

1. Press the  /  buttons to select the [8 Select Source] function.

The LCD displays the following message:

8. Select Source



2. Press the  (ENT) button, then press the  /  buttons to select the DVD Writer source, as shown below.

Src: HDD
01 IDE1 Master

3. Press the  (ENT) button.

The LCD displays the following message:

HDD Selected!

4. Press the  (ESC) button to go back to the main menu, then press the  /  buttons to select the [1. COPY] function.

The LCD displays the following message:

1. COPY	P: A
----------------	-------------

<i>Note: P: A means Partition A. To copy from this partition, you must first load an image (data). Please refer to the section “Basic Operation” on page 9 in Chapter 2 for more information.</i>
--

9 Image

The Image menu consists of seven functions (9.1 through 9.7). The Image menu includes Load, Delete Image, Image Info, Compare Image, Select Image, Image Src Drive, and Image Format Info functions. The data loaded onto the hard disk drive is called an “image file.”

9.1 Load

The factory-installed hard disk drive was partitioned and formatted at the factory. An alphabetical letter identifies each partition. Each partition is approximately 5GB in capacity. The number of partitions depends on the capacity of the hard disk drive. The Load function enables you to transfer data from the source DVD Writer drive to the current partition of the hard disk drive. (Note: P:A stands for partition A.) You can load as many disc images as the number of partitions available on the hard disk drive.

9.2 Delete Image

Use the Delete Image function to delete an image stored in a particular partition.

9.3 Image Info

Use the Image Info function to display basic information for an image file stored in a particular partition.

9.4 Compare Image

Use the Compare Image function to compare the contents of a disc in the source DVD Writer with the image file in the partition.

9.5 Select Image

The internal hard disk drive was partitioned and formatted at the factory. An alphabetical letter identifies each partition. Each partition is approximately 5GB in capacity. The number of partitions depends on the capacity of the hard disk drive. Use the Select Image function to select an image file that is stored in a specific partition on the hard disk drive.

9.6 Image Src Drive

Use the Image Src Drive function to select the DVD Writer drive as the source from which you can load data into a particular partition as an image file.

9.7 Image Format Info

The partitions on the hard disk drive can be configured to store a CD (1GB), DVD (5GB), or a Double Layer (DL) (10GB) image. The factory partitions the hard disk drive for DVD images at (5GB per partition). Use the Image Format Info function to verify this setting.

10. Edit Track (for CD only)

The Edit Track functions enable you to create and copy a collection of songs from different audio discs.



***Note:** The CD+G value must be set to OFF before you can use the Track Extraction feature. For more information, refer to “12 Advanced Setup (Adv Setup)” on page 27.*

10.1 CD to CD Edit

You can use this function to copy tracks from one or more discs and burn them to a CD-R. This function works only in the 1x4 mode of operation.

The CD to CD Edit function enables you to select specific tracks from various audio discs, combine them to create a collection of songs, and copy the collection to blank CD-R/CD-RW discs.

***Note:** CD-R discs support up to 80 minutes of audio. Therefore, the number of tracks that can be copied onto a single disc depends on the length of each individual track.*

1. Insert a source disc into the source optical drive and a blank CD-R disc into the target drive.
2. Switch to function [10.1 CD to CD] by pressing the  button.
3. Press the  (ENT) button.

The LCD panel displays the following:

10-01. Edit Track
CD to CD Edit

Selecting a Track from the First CD

4. Press the  (ENT) button again.

The LCD panel displays the following:

Select Track:
1/10 03:25

In this example, the indicator “1/10” refers to the first (1) of 10 tracks. The value “03:25” indicates the duration of the track.

You can press the  button to display (2) for the second (2) song, and so on.

In this example, we will choose to include the first track on our mix CD.

5. Select the first track, then press the  (ENT) button.



A plus sign (+) will be displayed next to the “1/10” indicator as shown below.

Select Track:
+1/10 03:25

Note: Pressing the  (ENT) button again will cancel your selection.

6. Press the  button to display End in the LCD panel, as shown below.

Select Track:
End 1Trk03:25

7. Press the  (ENT) button to finish CD editing.
8. Press the  /  buttons to display Yes.

**End edit disc
and burn? Yes**

Copying the Track

9. Press the  (ENT) button.

The system starts copying the track and displays the copying information as follows:

Copying - 24X Edit
1/10 -> 1/1

In the display above, the “1/1” indicator refers to the first track selected (1) out of the total number of tracks selected (1).

When the copy process is complete, the LCD panel displays the following message:

Burn Complete!
OK: 01

The system will ask if you want to keep editing.

10. To continue editing, press the  /  buttons to display Yes, as shown below.

Continue edit
next Disc? Yes

If you choose not to continue, select No, then skip to Step 18.

Selecting a Track from the Second CD

11. Press the  (ENT) button.

The current source CD will eject automatically, and the system will ask you to insert another source CD:

Insert next disc

12. Insert a different source CD, then press the  (ENT) button to begin the track selection process.

On this disc, we will select the second track.



13. Press the down arrow  to display Track 2 on the LCD panel, then press the  (ENT) button.

The LCD panel will display a plus sign (+) beside the 2/10 indicator as shown below.

Select Track:
+2/10 04:25

14. Press the up arrow  to display End in the LCD panel, as shown below.

Select Track:
End 1Trk04:25

15. Press the  (ENT) button to finish the CD editing, and then press the  /  buttons to display Yes.

**End edit disc
and burn? Yes**

Copying the Track

16. Press the  (ENT) button.

The system starts copying the track and displays the following copying information:

Copying - 24X Edit
2/10 -> 2/2

The indicator “2/2” represents the second (2) of the two (2) tracks we selected from different discs.

When the copy process is complete, the LCD panel displays the following message:

Burn Complete!
OK: 01

The system will then ask if you want to continue editing.

**Continue edit
next Disc? No**

In this example, we will choose not to continue.



17. Press the down arrow  to display “No.”

Closing the Session

18. Press the  (ENT) button.

The system will ask if you want to close the session for the CD.

**Close all disc's
session? Yes**

19. Press the  /  arrow buttons to display Yes, then press the  (ENT) button.

Once you indicate that you wish to close the session, the LCD panel will display the message as follows.

**Closing Session
Please wait...**

Note: You must close the session for the CD before you can play the CD.

10.2 CD to HDD

The CD to HDD function enables you to select one or more tracks from an audio CD-ROM disc and copy them to a specific partition on the hard disk drive.

Note: CD-R discs support up to 80 minutes of audio. Therefore, the number of tracks that can be copied onto a single disc depends on the length of each individual track.

10.3 Play Audio Track

This function is not available.

10.4 Close Session

This function finalizes your CD-R disc. Once the CD-R disc is finalized, no more audio can be added to that disc.

11 Setup

The Setup menu includes a list of options that enable you to change the original default configuration. Various settings are available under the Setup menu that control the operation of the DVD/CD Duplicator. However, it is recommended that you use the original default settings for optimal operation.

11.1 Language

The DVD/CD Duplicator LCD panel can display text in English and Spanish. The Language function enables you to select the display language. English is the default option.

11.2 CD Burn Speed

The CD Burn Speed setting controls the writing speed of the target drive when recording onto CD-R/CD-RW media. The default value is AUTO, which writes at the highest speed allowed by the media.

11.3 DVD Burn Speed

The DVD Burn Speed setting controls the writing speed of the target drive when recording onto DVD±RW media. The default value is MAXIMUM, which writes at the highest speed available on the target drive. On occasion, using the maximum writing speed will cause copy failure due to poor quality DVD±RW discs. In this case, it is recommended that you reduce the writing speed.

11.4 Read Speed

The Read Speed function enables you to set the reading speed of the target drive. MAXIMUM is the default setting.

11.5 Auto Start Drive

The Auto Start Drive setting enables the DVD/CD Duplicator to auto-start the copy or test process as soon as a blank disc is inserted into the target drive. The default setting is OFF.

11.6 Startup Menu

The Startup Menu setting enables you to select a menu item to be displayed as the first menu item when you turn on the DVD/CD Duplicator. COPY is the default.

11.7 Auto Verify

The Auto Verify setting controls auto verification of discs after a copy operation. The default setting is OFF.

11.8 Auto Compare

The Auto Compare setting controls auto-comparison of data between source and target discs after a copy operation. The default setting is OFF.

11.9 Auto Prescan

The Auto Prescan setting controls automatic prescan of the source disc whenever a data/audio disc is inserted in the optical source drive (1x4 mode of operation). The default setting is OFF.

11.10 Eject Disc

The Eject Disc setting controls the ejection of discs by the target drive. Three options are available:

- Eject Good Only – This option ejects only successfully copied discs. This is the default setting
 - Eject All Disc – This option ejects successful and failed copy discs.
 - Do Not Eject – With this option, all discs remain in the target drive. Manual ejection is required after every copy operation.
-

11.11 Burn on the Fly

The Burn on the Fly function enables you to control the copy operation. When the setting is ON, data is copied directly from the source DVD to the target DVDs. When the setting is OFF, the DVD/CD Duplicator first loads the data into a partition on the hard disk drive, then copies the data to the target DVDs.

11.12 Burn Mode

The Burn Mode setting enables you to select from two writing methods for CD-R media:

- Disc At Once (DAO)
- Track At Once (TAO)

DAO is the default setting.

11.13 Display Time

The Display Time function displays the total time of each copy operation. The default setting is OFF.

11.14 Button Sound

The Button Sound setting turns the button sound on or off. The default setting is ON.

11.15 Device Info

The Device Info function displays information for both the source and target drives.

11.16 System Info

The System Info function displays information for the interface board.

11.17 Quick Erase

The Quick Erase function performs a Quick Erase on DVD±RW discs.

11.18 Full Erase

The Full Erase function performs a Full Erase on DVD±RW discs. This function takes longer than the Quick Erase.

11.19 Auto Close Tray

The Auto Close Tray setting function closes the DVD writer's tray automatically after the recording is completed and the disc has been ejected. It is related to function 11.5 Auto Start Drive.

If you have not set any DVD writer to copy using function 11.5, the Auto Close Tray function will be invalid. If function 11.5 is valid, you can set for the writer's tray to close automatically after copying finishes. You can specify tray closure to occur within 5 to 50 seconds.

11.20 Quick Compare

With the Quick Compare function, you can specify a comparison of the source and the copied target discs in increments of 1byte through 100MB.



11.21 Audio Burn Speed



Use the Audio Burn Speed function to specify the write speed at which audio CDs will be recorded.

12 Advanced Setup (Adv Setup)

The Advanced Setup functions enable you to modify the system configuration. You should make changes only after you become completely familiar with the functions in this menu.

To enter Advanced Setup mode, press the  (ESC) button for two (2) seconds until you hear a beep.

Then use the down arrow button  to scroll through the various Advanced functions. Press the  (ENT) button to execute any of the Advanced functions.

To exit Advanced Setup mode, press the  (ESC) button twice, then press the down arrow button . The [1 Copy] command will appear on the LCD display.

12.1 UnderRun Protect

The UnderRun Protect setting turns Buffer UnderRun Protection on or off. The default setting is ON.

12.2 Overburn

The Overburn setting turns the Overburn function in the target drive on or off. The default setting is OFF.

For more information about Overburn discs, see item 5 in the FAQ on page 35.

12.3 Read Error Skip

The Read Error Skip setting controls error skipping during reading of the source disc.

If the setting is OFF and an error is detected, the target drive stops and displays the read error message.

If the setting is ON, no messages will be displayed if an error occurs. The copy operation will be completed and the copy will include all errors detected during the process.

The default setting is OFF.

12.4 Format HDD

(For factory use only; please do NOT use this function.)

<p>Warning! Do not run this function. It will erase all data already loaded into disk partitions. This function is reserved for factory use only.</p>
--

The factory-installed hard disk drive has already been partitioned and formatted and is ready for use.

12.5 Verify HDD

(For factory use only; please do NOT use this function.)

<p>Warning! Do not run this function. It will erase all data already loaded into disk partitions. This function is reserved for factory use only.</p>
--

The factory-installed hard disk drive has already been partitioned and formatted and is ready for use.

12.6 Burn-in

The Burn-in function runs an emulate writer function continuously. The disc in the target drive is ejected and re-inserted automatically between each test cycle. This function can be prepared to run continuously or specified to run from 1 to 1000 times.

12.7 Update Firmware

The Update Firmware function updates the firmware of the interface board via a CD or DVD disc. The disc must contain the required data file and be inserted in the source drive. The DVD/CD Duplicator will locate the data and update its firmware automatically. During the update, do not turn off the power to the unit. The update process is complete after the system resets automatically and displays the main menu.

12.8 Compare Firmware



The Compare Firmware function compares the current firmware version in the interface board to the update version in the CD or DVD disc.

12.9 H/W Diagnostic

The H/W Diagnostic function detects the devices connected to the interface board, confirms functionality, and displays information about the hardware on the LCD.

12.10 Load Default



The Load Default function resets all settings to factory default values. It is recommended that you reset to the default values if the DVD/CD Duplicator fails to function properly after you make changes to the original configuration. To execute the Load Default function, follow the steps below:

1. Press and hold down the  (ESC) button for two (2) seconds until you hear a beep.
2. Press the down arrow  to display 12.10 Load Default.
3. Press the  (ENT) button.

The system displays the message: Load Default Config? Yes.

4. Press the  (ENT) button.

The system starts loading the default data. When the loading operation is complete, the system displays the message: Load Default OK.

5. Press the  (ESC) button twice, then press the down arrow  to return to the main menu.

The system displays 1.Copy P:A.

Note: P:A means Partition A. Therefore, the default setting for the Duplicator is 1x5 mode (one source hard disk drive and five target optical drives). If there is no data in Partition A, change the setting to 1x4 mode (one source optical drive and four target optical drives). Please refer to the Select Source function on page 16.

12.11 CD+G

The CD+G function enables or disables CD+G (karaoke CD) format support. The default setting is OFF.

Note: The CD+G value must be set to OFF before you can use the Track Extraction features.

For more information about CD+G discs, see item 7 in the FAQ on page 35

12.12 ISRC & MCN

The ISRC & MCN function enables or disables ISRC and MCN format support. The default setting is OFF.

12.13 USB Option

The USB Option function is not applicable to Rackmount DVD/CD Duplicators.

12.14 CD-Text

The CD-Text function enables or disables the copying of CD-Text discs. The default setting is OFF.

For more information about CD-Text discs, see item 8 in the FAQ on page 35.

Appendix A. List of Functions

- 1 Copy
- 2 Test
- 3 Test & Copy
- 4 Verify
- 5 Compare
- 6 Prescan
- 7 Disc Info
- 8 Select Source

- 9 Image
 - 9.1 Load
 - 9.2 Delete Image
 - 9.3 Image Info
 - 9.4 Compare Image
 - 9.5 Select Image
 - 9.6 Image Src Drive
 - 9.7 ImageFormat Info

- 10 Edit Track (for CD only)
 - 10.1 CD to CD Edit
 - 10.2 CD to HDD
 - 10.3 Play Audio Track
 - 10.4 Close Session

- 11 Setup
 - 11.1 Language (Default is English.)
 - 11.2 CD Burn Speed (Default is Auto.)
 - 11.3 DVD Burn Speed (Default is Maximum.)
 - 11.4 Read Speed (Default is Maximum.)
 - 11.5 Auto Start Drive (Default is Off.)
 - 11.6 Startup Menu (Default is Copy.)
 - 11.7 Auto Verify (Default is Off.)
 - 11.8 Auto Compare (Default is Off.)
 - 11.9 Auto Prescan (Default is Off.)
 - 11.10 Eject Disc (Default is Eject Good Only.)
 - 11.11 Burn on the Fly (Default is On.)
 - 11.12 Burn Mode (Default is DAO.)
 - 11.13 Display Time (Default Off.)
 - 11.14 Button Sound (Default is On.)
 - 11.15 Device Info
 - 11.16 System Info
 - 11.17 Quick Erase
 - 11.18 Full Erase
 - 11.19 Auto Close Tray
 - 11.20 Quick Compare
 - 11.21 Audio Burn Speed

- 12 Advanced Setup (Adv Setup)
 - 12.1 UnderRun Protect (Default is On)
 - 12.2 Overburn (Default is Off)
 - 12.3 Read Error Skip (Default is Off)
 - 12.4 Format HDD (factory use only)
 - 12.5 Verify HDD (factory use only)
 - 12.6 Burn-in
 - 12.7 Update Firmware
 - 12.8 Compare Firmware
 - 12.9 H/W Diagnostic
 - 12.10 Load Default
 - 12.11 CD+G (Default is Off)
 - 12.12 ISRC & MCN (Default is Off)
 - 12.13 USB Option
 - 12.14 CD-Text (Default is Off)

Appendix B. LCD Messages

This appendix explains the messages that may appear on the LCD panel.

Normal Conditions

Message	Meaning
Initialize SDRAM	Initialize system memory.
Detect drives	Detect the drives connected to the system.
User Abort	Cancel a job during operation.
Analyzing	Analyze the source disc.
Source Drive Not Ready	Source drive is not ready to read.
Target Drive Not Ready	Target drive is not ready to write.
Erasing disc	The system is erasing the data on the disc.
Source Disc Not Ready	Source disc is not ready to be read.
Target Disc Not Ready	Target disc is not ready to be written into.
Fail to get Drive Info!	Drive information cannot be obtained.
Fail to get SRC Disc Info!	Information about a source disc cannot be obtained.
Save new config Fail!	The new configuration settings cannot be saved.
Load Default Config?	Do you want to load the default settings?
Src&Tgt can't in the same channel	During comparison, the source and target discs cannot occupy the same channel.
Preparing	The system is preparing to record.
Check Target Please Wait	The system is checking the target device.
Audio Disc!!!Can't compare!	The system cannot compare the audio disc.
Identical	Comparison results are identical.
Read disc error	During a comparison, the disc could not be read.
Cannot read TOC	The system cannot read the contents of the disc.
TOC not match	Comparison results are not identical.
Source Disc Empty!!!	The source disc contains no data.
Target overflow	The target disc capacity is insufficient to store new data.
Target Disc Not Empty!!!	The target disc still contains data.
Press a Key to Eject Good Disc	Press any key to eject a disc after copying. (Copy successful.)
Press a key to Eject Fail Disc	Press any key to eject a disc after copying. (Copy failed.)
DVD-RW does not Support the Func	DVD-RW does not support this function.
Hold ESC to exit	Press ESC for one second to terminate the test.
All data will be lost, erase?	All data on the disc will be lost. Confirm erasure request.
Erase Finished	The erasing of the data is complete.
No Erasing to Disc in DVD-RW!!	The disc in the DVD-RW drive is not rewritable.

Message	Meaning
HDD not Format!	The hard disk has not been formatted.
Format HDD?	Do you want to format the hard disk?
All data will be lost, format?	All data on the hard disk will be lost. Confirm the format request.
Format HDD OK!	Formatting of the hard disk is complete.
Image load OK	The image has been successfully loaded from DVD to the hard disk.
Image load Fail	The image has not been loaded successfully from DVD to the hard disk.
HDD too small to handle image!	The hard disk capacity is insufficient to store the data image (at least 5Gbytes is required).
No Valid HDD!	The system cannot locate a hard disk.
HDD too small	The hard disk capacity is too small.
No Image in Partition xx	There is no data image in the specified partition.
Image Exists Overwrite?	The current partition contains a data image. Confirm the overwriting request.
Delete Image in Partition xx?	Confirm the request to delete the data image in the specified partition.
Partition Damage	The partition is damaged.
Verify Disk Or Partition?	Do you want to verify the entire hard disk or only a partition?
Verify Hard Disk OK!	The hard disk has been verified successfully.
Verify the Hard Disk Fail!	The hard disk has not been verified successfully.
Verify Partition Header!	Verify the partition header.
Select HDD First!	First select a formatted hard disk.

Audio Editing

Message	Meaning
Lost selected Tracks?	Abort and delete the selected tracks.
End edit disc and burn?	Finish the music disc editing and start to copy.
Continue edit next Disc?	Do you want to continue the music disc editing?
Target Overflow Re-Select	The disc capacity is insufficient to store the selected tracks. Please select fewer tracks.
Close all disc's session?	Confirm the closing of disc sessions.
Can't edit HDD	The hard disk cannot be edited as a source audio disc.
NO AUDIO track in this disc	The source disc contains no audio tracks.
Insert next disc	Insert the next audio disc.
Sessions were closed already!	The disc sessions have already been closed.
Burn or Move to partition?	Do you want to copy the data directly to disc or transfer the data to a hard disk partition?
Tgt overflow, del last trk?	Disc capacity is insufficient to store the selected tracks. Do you want to delete the last track?
Ins empty disc Continue?	Do you want to insert a blank disc and continue copying?

Appendix C. Frequently Asked Questions (FAQ)

The following FAQ section may help you to resolve some common problems.

1. How do I reset the unit to its factory settings?

Refer to function “12.10 Load Default” on page 29. Carefully follow the step-by-step instructions.

2. When I tried to copy a disc, the LCD displayed Source Disc Empty!!! and the target drive’s tray was ejected simultaneously. What should I do?

The factory settings may have been changed. Reset the duplicator to the factory default settings. Refer to function “12.10 Load Default” on page 29. Carefully follow the step-by-step instructions.

3. What does the Target Drive Not Ready error message mean?

This message is displayed when one of the target drives is not ready to record because, for example, a blank disc is dirty or scratched. Clean the target disc. If it has been scratched, replace it with a new one.

Try using a different brand of disc to make sure that the failure is not related to disc specifications or quality.

You may also encounter this problem if you try to use a disc that is not blank. (The Rackmount DVD/CD Duplicator accepts only blank DVD/CD discs in the target drives).

This message may also be displayed if the source disc is copy-protected. In such a case, insert a disc that is not copy-protected. In accordance with applicable laws, the Duplicator is designed to be unable to bypass any copy-protection technology that may be encoded on the source disc.

If the error message continues to appear even with different target or source discs, contact our Technical Support Group.

4. What does the Source Drive Not Ready message mean?

This message is displayed when the source (upper) drive is not ready to read because, for example, the master disc is dirty or scratched. Clean the source disc. If it is scratched, use a different source disc.

The message may also be displayed if the source disc is empty. Be sure to insert a data/music/video disc in the source drive.

This message may also be displayed if the source disc is copy-protected. In such a case, insert a disc that is not copy-protected. In accordance with applicable laws, the duplicator unit is designed to be unable to bypass any copy-protection technology that may be encoded on the source disc.

If the error message continues to appear even with different source discs, contact our Technical Support Group.

5. What does the Target Overflow message mean?

This message may be displayed when the source master CD disc contains data/music in excess of the 700MB/80min disc capacity.

These types of discs are often called “Overburn” discs. Attempting to copy an Overburn disc might generate read errors at the end of the disc, making the disc unreadable in regular CD readers. Although this type of recording is not recommended, this unit is capable of duplicating Overburn discs.

Refer to “12 Advanced Setup (Adv Setup)” on page 27 for more information.

Then, execute function “12.2 Overburn” on page 27 to change the setting to the ON state. Follow the instructions to exit the Advanced Setup first, and then execute the [1.Copy function]. This time, the unit will again display the message and prompt you to continue. Press the  (ENT) button to create an Overburn copy.

This message may be displayed when a source DVD disc is copy-protected, such as a purchased/rented DVD movie/game. There is no Duplicator on the market that can copy these discs, as doing so is a violation of Federal law. Replace the source DVD disc with a non-copy protected disc.

This message may also be displayed if the Source DVD disc has a capacity larger than the DVD disc in the target drive. Make sure that both source and target discs have the same capacity. For example, if the source DVD disc is an 8.5GB capacity disc, make sure the target DVD disc is also an 8.5GB disc.

6. What media is recommended?

For best results, brand-name media is recommended (for example: Memorex, Imation, TDK, Verbatim, Fuji-Film, etc.)

7. How do I copy a CD+G (Karaoke) disc?

The CD+G feature is set to OFF as a default.

Refer to “12 Advanced Setup (Adv Setup)” on page 27 for more information. Then execute function “12.11 CD+G” on page 30 to change the setting to the ON state. Follow the instructions to exit the Advance Setup first, and then execute the [1.Copy] function.

8. How do I copy a CD Text disc?

The CD Text feature is set to “OFF” as a default. Refer to “12 Advanced Setup (Adv Setup)” on page 27.

Then execute function “12.14 CD-Text” on page 30 to change the setting to the ON state. Follow the instructions to exit the Advance Setup first, and then execute the [1.Copy] function.

9. How do I extract audio tracks from different CD discs to create a compilation audio CD?

On the main menu, go to function [10 Edit Track] and press the  (ENT) button.

Press the  (ENT) button to execute the [10.1 CD to CD Edit] function. Follow the step-by-step instructions described on page 19.

Appendix D. About DVD±R and DVD±RW Discs

This appendix explains how to handle, load, and eject compact discs, including DVD±R and DVD±RW discs.

Handling Discs

- ❑ Handle compact discs (including DVD±R and DVD±RW discs) only by their edges to avoid getting fingerprints on the surface of the disc. Do not touch the disc's data surface (unlabeled side).
- ❑ Do not place discs in direct sunlight or in locations subject to high humidity, high temperatures, or dusty conditions.
- ❑ If it becomes necessary to clean a disc due to erratic operation, visible dust, or smudges, gently wipe the surface of the disc from the center to the outside edge. Do not use benzene, alcohol, thinner or other solvents.

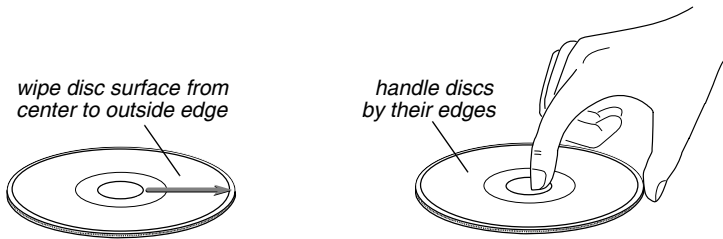

Figure 7. How to Handle Compact Discs (including DVD±R and DVD±RW)

Loading and Ejecting Discs

To load a disc into the source or a target drive, first open the disc tray by pressing the Load/Eject button on the front of the drive. Place the disc on the disc tray with its label side facing up. Then press the Load/Eject button again to retract the disc tray back into the drive.

To eject a disc from the source or a target drive, press the Load/Eject button on the front of the drive to extend the disc tray. Remove the disc from the disc tray and place it in its protective case. Then press the Load/Eject button again to retract the disc tray back into the drive.

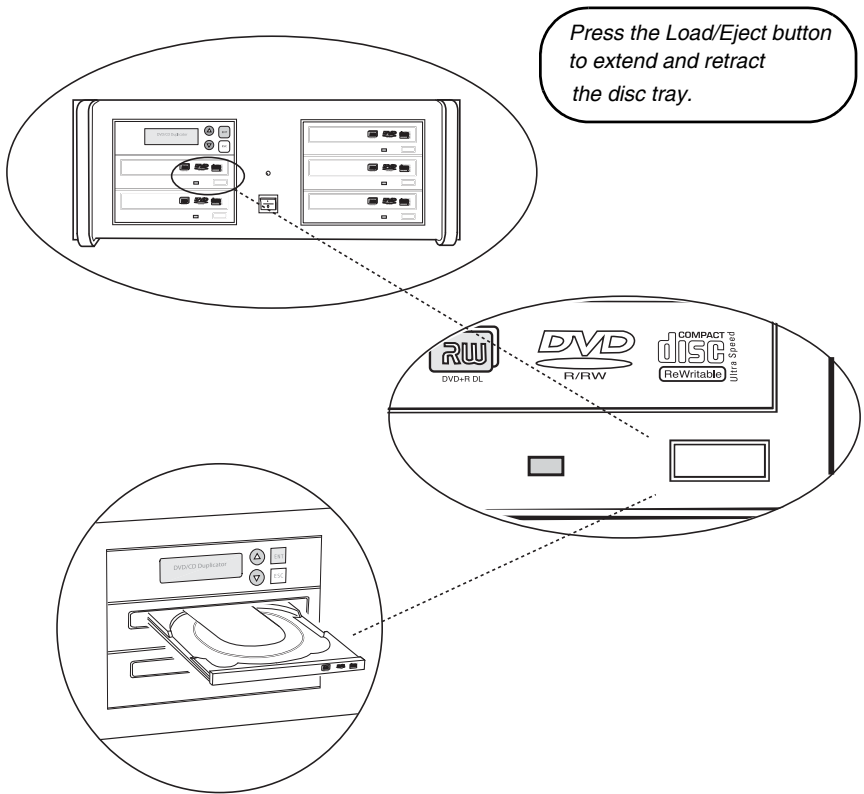

Figure 8. Ejecting the Disc Tray

Appendix E. Specifications

The following table lists the product specifications for the Rackmount DVD/CD Duplicator.

MODEL >		DV-W14R
LCD Panel Logo		TASCAM
HDD Capacity	160GB	
DVD Recorders	20X DVD±RW	
Read Speed	DVD: 16x; CD: 48x	
Write Speed	DVD: 20x; CD: 48x	
Drive Buffer Size	2MB	
System Buffer Size	128MB	
Supported Discs	DVD+R, DVD+RW, DVD+DL, DVD-R, DVD-RW, DVD-R DL, CD-R and CD-RW	
System Control	Copy and Search Buttons	
System Display	LCD Panel; LED Indicator	
Write Method	Auto Detect (DAO, TAO)	
Operation Mode	Copy, Test, Scan, Compare	
Firmware Upgrade	Via CD-ROM/DVD-ROM	
Weight	50 lbs.	
Dimensions	7 inches H x 17 inches W x 18 inches D	
Environment	5° C to 35° C	
Power Supply	AC Input: 100 - 240V	
Agency Certification	UL and FCC	

Appendix F. Technical Support

For technical support, please contact the TEAC and TASCAM Support Center.

Technical Support

Telephone: (323) 727-4860 • Fax: (323) 869-8751

Monday - Friday 8:00 am to 12:00 pm and 1:00 pm to 5:00 pm PST

<http://www.teac.com/support>

E-mail: dspdtsg@teac.com