

**1x1 DVD Duplicator
User's Manual**

**DVW-D11
DVW-D11H**

TEAC®

Safety Precautions

TEAC DVD Duplicator systems are high-precision electronic devices. Do not use them in any manner other than as specified in this manual. Please read this manual in its entirety before you begin the installation procedure. Use of controls, adjustments, or performance of procedures other than those specified herein may result in hazardous radiation exposure.

To prevent fire or shock, do not expose the unit to moisture or rain.

To prevent electrical shock, do not attempt to disassemble the DVD Duplicator system. Refer servicing to authorized personnel.

TEAC DVD Duplicator drives utilize a laser beam that can be harmful to your eyes. Do not disassemble the cabinet or unit. Do not attempt to look through the front panel or into the unit while the power is turned on.

A user who changes or modifies the unit or operating procedures specified herein without expressed written approval by the manufacturer will void user authority to operate the equipment.

Specifications and features subject to change without notice or obligation.

Copyright and Trademark Information

© Copyright 2005 TEAC America, Inc. All rights reserved.

TEAC America, Inc. reserves the right to modify product offerings or specifications without advanced notice. No part of this publication may be reproduced in any format without the expressed written permission of TEAC America, Inc.

TEAC is a trademark of TEAC Corporation. All other trademarks and registered trademarks are the property of their respective owners.

Piracy Statement

Copying audio, video, or software without the permission of the copyright holder is illegal. TEAC accepts no responsibility for copyright infringement or misuse of this equipment. It is the sole responsibility of the user to ensure that the legal copyrights of the copyright owners are respected.

About This Manual

This *TEAC DVD Duplicator User's Manual* explains how to operate the TEAC DVD Duplicator. It is divided into the following chapters:

Chapter 1: Introduction

This chapter describes the shipping package contents and introduces the TEAC DVD Duplicator.

Chapter 2: Using the DVD Duplicator

This chapter explains how to set up the DVD Duplicator. It also details its basic copy operation.

Chapter 3: DVD Duplicator Functions

This chapter explains all available functions of the DVD Duplicator.

Appendix A: List of Functions

Appendix A includes a complete list of all DVD Duplicator functions.

Appendix B: LCD Messages

Appendix B lists all messages that may appear on the LCD display.

Appendix C: About DVD-R and DVD-RW Discs

Appendix C contains information about handling, loading, and ejecting discs.

Appendix D: Specifications

Appendix D includes technical specifications for the TEAC DVD Duplicator units.

Appendix E: Technical Support and Warranty

Appendix E explains how to contact technical support at TEAC America, Inc. and provides Limited Warranty information.

Table of Contents

Safety Precautions	i
Copyright and Trademark Information	ii
Piracy Statement	ii
About This Manual	ii
List of Figures	v
Chapter 1. Introduction	1
DVD Duplicator Package Contents	2
Front Panel	3
Rear Panel	5
Chapter 2. Using the DVD Duplicator	7
Setup	7
Basic Operation	8
Copying from the Optical (DVD) Source Drive	8
Loading Data to and Copying from the Hard Disk Source Drive	9
Chapter 3. DVD Duplicator Functions	13
1 Copy	13
2 Test	13
3 Test & Copy	14
4 Verify	14
5 Compare	14
6 Prescan	14
7 Disc Info	14
8 Select Source	14
9 Image	15
9.1 Load	15
9.2 Delete Image	15
9.3 Image Info	15
9.4 Compare Image	15
9.5 Select Image	15
9.6 Image Src Drive	15
9.7 Image Format Info	16
10. Edit Track (for CD only)	16
10.1 CD to CD Edit	16
10.2 CD to HDD	16
10.3 Play Audio Track	16
10.4 Close Session	17
11 Setup	17
11.1 Language	17
11.2 CD Burn Speed	17
11.3 DVD Burn Speed	17
11.4 Read Speed	17
11.5 Auto Start Drive	17
11.6 Startup Menu	18
11.7 Auto Verify	18

Table of Contents

11.8 Auto Compare	18
11.9 Auto Prescan	18
11.10 Eject Disc	18
11.11 Burn on the Fly	18
11.12 Burn Mode	19
11.13 Display Time	19
11.14 Button Sound	19
11.15 Device Info	19
11.16 System Info	19
11.17 Quick Erase	19
11.18 Full Erase	19
12 Advanced Setup (Adv Setup)	19
12.1 UnderRun Protect	20
12.2 Overburn	20
12.3 Read Error Skip	20
12.4 Format HDD	20
12.5 Verify HDD	20
12.6 Burn-in	21
12.7 Update Firmware	21
12.8 Compare Firmware	21
12.9 H/W Diagnostic	21
12.10 Load Default	21
12.11 CD+G	21
12.12 ISRC & MCN	21
12.13 CD-Text	22
12.14 Switch USB Mode	22
Appendix A. List of Functions	23
Appendix B. LCD Messages	24
Normal Conditions (for both DVD Duplicator models)	24
Normal Conditions (for the model that features a hard disk drive)	25
Audio Editing	25
Appendix C. About DVD-R and DVD-RW Discs	26
Handling Discs	26
Loading and Ejecting Discs	27
Appendix D. Specifications	28
Appendix E. Technical Support and Warranty	29
Limited Warranty	29

List of Figures

Figure 1. DVD Duplicator Unit Package Contents	2
Figure 2. Front Panel of the DVD Duplicator Unit	3
Figure 3. LCD Control Panel	3
Figure 4. Rear Panel of the DVD Duplicator Unit	5
Figure 5. Copy Function on LCD Panel	7
Figure 6. How to Handle Compact Discs (DVD-R and DVD-RW)	26
Figure 7. Ejecting the Disc Tray	27

Chapter 1. Introduction

Thank you for purchasing a TEAC DVD Duplicator.

Note:

- ❑ *TEAC 1x1 DVD Duplicators are available in various models with or without internal hard disk drives. Please refer to “Specifications” on page 28 for detailed information on the model you purchased.*
- ❑ *This document, the TEAC 1x1 DVD Duplicator User's Manual, is intended for DVD Duplicator models DVW-D11 and DVW-D11H. Operational instructions for both models are essentially the same. The primary difference between models is that the DVW-D11H features an internal hard disk drive, which you can use as an alternative source drive.*

The TEAC DVD Duplicator is a stand-alone disc-to-disc DVD Duplicator system that does not require connection to a computer. It can duplicate a single master DVD to DVD media at up to 16X speeds, resulting in an exact replica of a 4.7GB disc. It can also duplicate discs to CD-R media at up to 48X speeds.

The TEAC DVD Duplicator is designed to perform DVD copying quickly and accurately. The DVD Duplicator automatically identifies source DVD formats and replicates the content as required.

The TEAC DVD Duplicator performs continuous copying with no waiting. It is an ideal DVD Duplicator for the advanced user who requires speed and accuracy.

You can set up your TEAC DVD Duplicator very quickly and easily. There is no need to install any software. There is no need to attach any cables to your computer. The TEAC DVD Duplicator functions entirely as a stand-alone unit.

DVD Duplicator Package Contents

Your TEAC DVD Duplicator package includes the following items (see Figure 1).

- TEAC (1x1) DVD Duplicator unit
- AC power cable
- TEAC DVD Duplicator User's Manual* (this booklet)

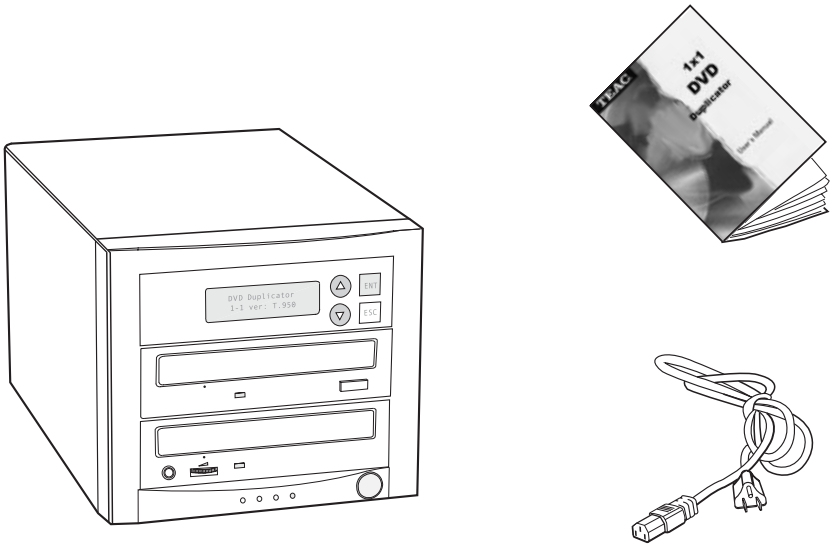

Figure 1. DVD Duplicator Unit Package Contents

Note: If any of the items above is missing from your package upon purchase, please contact your vendor immediately.

Front Panel

Figure 2 illustrates the front panel of the DVD Duplicator unit.

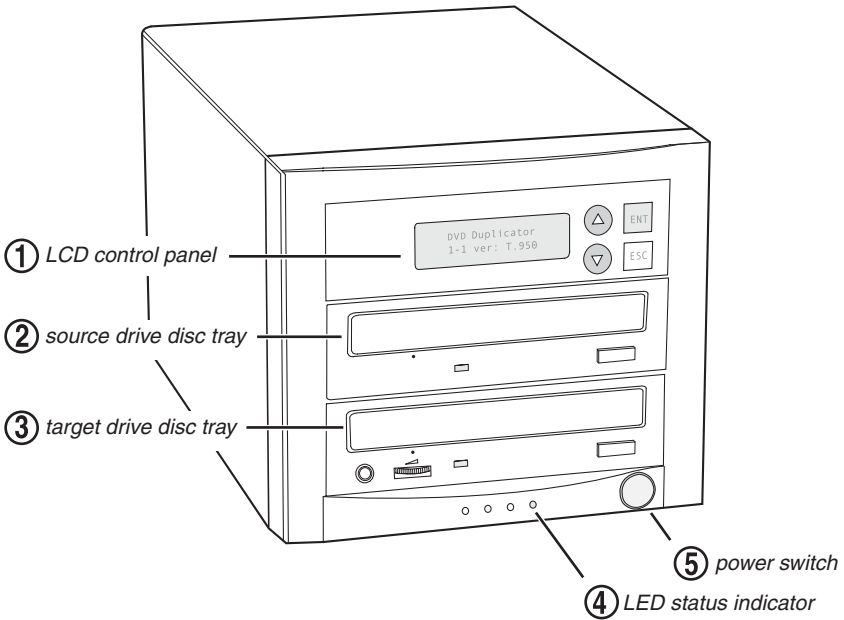

Figure 2. Front Panel of the DVD Duplicator Unit

- ① **LCD control panel:** Use the control panel buttons to navigate through the various functions viewed on the LCD display.

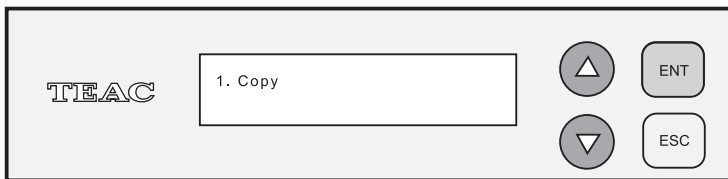





Figure 3. LCD Control Panel

The DVD Duplicator control panel features an LCD display and four buttons. These buttons are described in the following table:

	Press the Up arrow button to scroll up functions or menus.
	Press the Down arrow button to scroll down functions or menus.

	Press the ENT (Enter) button to execute a selected function.
	Press the ESC (Escape) button to cancel a selected function or to return to the main menu.

- ② **source drive disc tray:** Insert the disc to be copied into the source drive. Use the disc tray to load a DVD into the drive. You can open the tray by pressing the eject button (if the tray fails to open, you can use the emergency eject mechanism). You can close the tray by pressing the eject button.

Notes:

- TEAC strongly recommends that you do not push the tray in to close it. Please press the eject button to eject or retract the tray.*
- The DVD Duplicator may include an internal hard disk drive as an alternate source drive. Please refer to “Specifications” on page 28 for detailed information on the model that you purchased.*

- ③ **target drive disc tray:** Insert a blank disc into the target drive to make a copy of the source disc. You can open the tray by pressing the eject button (if the tray fails to open, you can use the emergency eject mechanism). You can close the tray by pressing the eject button.

Note: *TEAC strongly recommends that you do not push the tray in to close it. Please press the eject button to eject or retract the tray.*

- ④ **LED power indicator:** The LED power indicator will be continuously lit when the DVD Duplicator power is on.
- ⑤ **power switch:** Use the power switch to turn the power to the DVD Duplicator unit on and off.

Rear Panel

Figure 4 illustrates the rear panel of the DVD Duplicator unit.

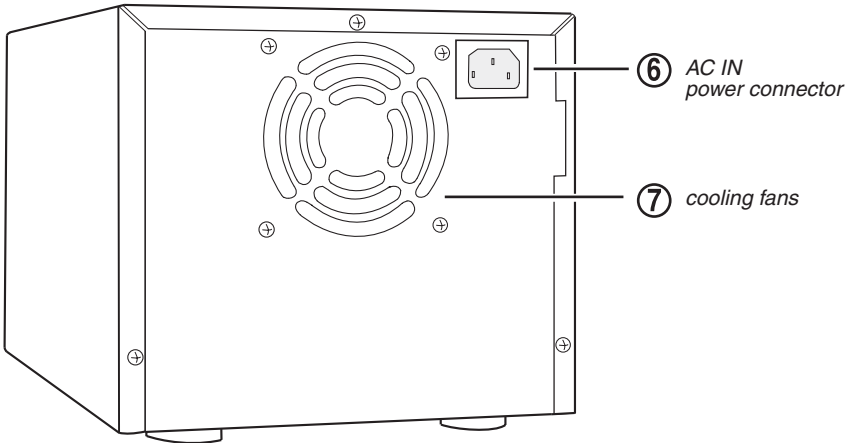

Figure 4. Rear Panel of the DVD Duplicator Unit

- ⑥ **AC IN power connector:** Connect the included AC power cable to this input connector. Plug the other end of the power cable into a three-prong receptacle AC power outlet.

Caution: Do not attempt to bypass the grounding plug. Otherwise, you risk electrical shock or damage to the unit.

Note: To ensure proper operation, use only the original AC power cable with your TEAC DVD Duplicator unit.

- ⑦ **cooling fan:** Ball-bearing fan cools the DVD Duplicator.

Chapter 2. Using the DVD Duplicator

This chapter explains how to set up the DVD Duplicator, as well as basic operation and menu functions.

***Note:** The following instructions are applicable to both DVD Duplicator models DVW-D11 and DVW-D11H. Operational instructions for both models are essentially the same. The primary difference between models is that the DVW-D11H has an internal hard disk drive, which you can use as an alternate source drive.*

Setup

1. **Carefully remove the DVD Duplicator unit, AC power cord and user's manual from the shipping box.**

***Note:** Please keep the original box and packaging materials for use in the event of future storage or transportation of the unit.*

2. **Connect one end of the included power cable to the back of the DVD Duplicator. Connect the other end of the power cable to a three-prong receptacle AC outlet.**

***Caution:** Do not attempt to bypass the grounding plug. Otherwise, you risk damage to the unit and electrical shock.*

3. **Turn on the power to the DVD Duplicator by pressing the power button on the lower right-hand side of the unit.**

During initialization, the DVD Duplicator performs a self-test in which the unit's internal buffer is tested, source and target drives are detected, and the LCD display is tested. Once the initialization is complete, the DVD Duplicator is ready for use.

The LCD initially displays the Copy function by default.

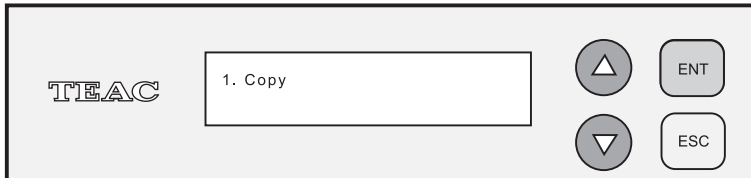



Figure 5. Copy Function on LCD Panel

Basic Operation

This section explains the basic operation of the DVD Duplicator.

Copying from the Optical (DVD) Source Drive

Note: The following instructions apply to both DVD Duplicator models.

1. Place a source disc in the disc tray of the source drive.
2. Switch to function [1 Copy] by pressing the  button (if necessary).
3. Place a blank DVD-R disc into the target drive, then press the  (ENT) button to start copying.

When the copy operation is complete, the DVD disc in the target drives will be ejected automatically.

Note:

- With the default setting, after a source disc has been successfully copied, the DVD Duplicator automatically ejects the target DVD disc.
- With the default setting, if the copy operation fails, the failed target DVD disc remains in the target drive. To remove the failed DVD disc, press the eject button on the target drive and retrieve the disc. Press the eject button again to retract the disc tray. You can change the default settings by using the [Advanced Setup] menu. (For more information, see “12 Advanced Setup (Adv Setup)” on page 19.)

Loading Data to and Copying from the Hard Disk Source Drive

Note: The following instructions apply only to the DVD Duplicator model that features a factory-installed hard disk drive (DVW-D11H).

During initialization (see Step 3 on page 7), the DVD Duplicator performs a self-test to detect source drives. The DVD-ROM drive and hard disk drive will be detected as available source drives. The DVD-ROM drive is the default source drive.

The internal hard disk drive was formatted and partitioned at the factory. Each partition occupies 5GB of hard disk space. The number of partitions depends on the capacity of the hard disk drive. Partitions are arranged alphabetically and initially contain no data. A set of data loaded into a partition on the hard disk drive is called an “image file.”

To use the hard disk drive as the source drive, you must first load an image file from a DVD onto a partition on the hard disk drive, select the partition that contains the data you want to copy, specify the hard disk drive as the source drive, then execute the copy function.

1. Insert a source DVD into the DVD-ROM drive.

This disc (DVD-ROM or DVD) contains the data that you wish to copy to the partition on the internal hard disk drive.

2. Press the / buttons to select function menu [9 Image], then press the (ENT) button.

The Image menu includes the Load, Delete Image, Image Info, Compare Image, Select Image, Image Src Drive and ImageFormat Info functions.

3. Press the / buttons to select function [9-5 Select Image], then press the (ENT) button to access the Select a Partition submenu.

The Select a Partition submenu enables you to select a partition (A, B, C, etc.) into which to load an image file on the hard disk drive. (When the unit is shipped from the factory, the partitions on the hard disk drive contain no data.)

The LCD will display a message similar to the following for each corresponding partition:

Select a Partition

No image in A

4. Press the  /  buttons to select the desired partition letter.

The LCD will display partition A as the first option, but you can select any partition letter at any time.



5. Press the  (ENT) button to confirm the desired partition.

The LCD will display a message similar to the following:

Set Partition To A

(If you selected partition B, the LCD will display the message: Set Partition To B, and so on.)

6. Press the  (ESC) button to return to function menu [9 Image].

7. Press the  /  buttons to select function [9-1 Load], then press the  (ENT) button to transfer data from the DVD to the specified partition on the hard disk drive.

The data (image file) on the DVD in the source drive will be copied onto the partition you selected in Step 5.

Note: To help you quickly locate your data in the future, TEAC recommends that you keep track of the data that you load into each partition.



8. Once the data is loaded successfully, remove the source disc from the DVD-ROM drive.
9. Repeat Steps 1 through 8 to load additional image files from other DVDs to other partitions, if desired.

At this point, the selected partition is the same as the one you selected in Step 5 above. If you want to copy from this partition, skip to Step 12.







If you want to copy an image file from another partition into which you have already loaded data, continue with Step 10.

10. Press the  /  buttons to select function [9-5 Select Image], then press the  (ENT) button to access the Select a Partition submenu.

The Select a Partition submenu also enables you to select a partition (A, B, C, etc.) from which you want to copy an image file.

11. Press the  /  buttons to select the partition you wish to copy from, then press the  (ENT) button.

The data will be copied from the selected partition when you specify the hard disk drive as the source and execute the copy function as described in Steps 13 through 16.

12. Press the  (ESC) button twice to exit to the DVD Duplicator's main menu.
13. Press the  /  buttons to select function menu [8 Select Source], then press the  (ENT) button to access a list of available source drive options.
14. Press the  /  buttons to select the hard disk drive, then press the  (ENT) button.

The hard disk drive is now designated as the source drive.

15. Press the  button to switch to function [1 Copy].

The LCD will display a message similar to the following:

1 Copy. P : A

This message indicates that the data will be copied from the hard disk drive's partition "A" (which was selected in Step 11).

(If you selected partition B, the LCD will display the message: "1 Copy. P : B," and so on.)

16. Place a blank DVD-R disc into the target drive, then press the  (ENT) button to start copying.

Note:

- ❑ *With the default setting, after source data has been successfully copied to the target DVD disc, the DVD Duplicator automatically ejects the disc.*
- ❑ *With the default setting, if the copy operation fails, the failed target DVD disc remains in the target drive. To remove the failed DVD disc, press the eject button on the target drive and retrieve the disc. Then press the eject button again to retract the disc tray. You can change the default settings by using the [Advanced Setup] menu. (See “12 Advanced Setup (Adv Setup)” on page 19.)*

Chapter 3. DVD Duplicator Functions

The DVD Duplicator features 12 functions: Copy, Test, Test & Copy, Verify, Compare, Prescan, Disc Info, Select Source, Image, Edit Track, Setup, and Advanced Setup. Each function is explained below.

1 Copy

The Copy function enables you to copy data from a source DVD or a partition on the internal hard disk (if your DVD Duplicator features a factory-installed hard disk drive). For more information, refer to “Basic Operation” on page 8.

To copy data to one of more DVD-R discs, follow the steps below:

1. **Switch to function [1 Copy] by pressing the  button.**
2. **Insert a source disc in the source drive and a blank DVD-R disc into the target drive.**

(Note: If your DVD Duplicator features a factory-installed hard disk drive and you wish to copy data from a partition on the hard disk, refer to “Loading Data to and Copying from the Hard Disk Source Drive” on page 9.)

3. **Press the  (ENT) button.**

When the copy operation is complete, the target drive ejects the copied disc.

4. **To make additional copies of the same source disc, insert another blank DVD-R disc into the target drive and press the  (ENT) button.**

Otherwise, press  (ESC) to return to the main menu.

***Note:** You can use DVD-RW discs that already contain data (i.e., DVD-RW discs that are not fully blank) as target discs. However, the data stored on the DVD-RW disc will be erased automatically before the new data is copied. No special setting or procedure is required to erase the old data.*

2 Test

The Test function simulates writing to the target disc. Discs will remain blank after the test is complete. This function is recommended if you are using unsupported media. This function enables the target drive to adjust its laser to the proper intensity.

Note: Unexpected termination or cancellation of a test will not affect a target DVD-R disc. The target DVD-R disc will remain blank and available for use. However, DVD-RW discs that contain data may be damaged and the data they contained may be rendered unrecoverable. It may be necessary to re-start the DVD Duplicator if the target drive hangs during a sudden termination.

3 Test & Copy

The Test & Copy function performs the test simulation and the copy process in one step.

The copy process is performed only if the simulation detects no problems. If the simulation fails, the copy process is cancelled.

4 Verify

The Verify function verifies that the target disc was written completely and with no errors.

5 Compare

The Compare function compares data on the source and target discs after the copy process is complete.

Note: This function works only with data discs.

6 Prescan

The Prescan function is performed on the source drive. This function scans the disc to determine the maximum data/audio extraction speed.

7 Disc Info

The Disc Info function displays detailed information about the source disc, including sessions, tracks, capacity, etc.

8 Select Source

The Select Source function enables you to select a drive (DVD-ROM drive, DVD Writer drive, or hard disk drive) as the source from which to copy. You can select a hard disk drive only on those DVD Duplicator systems that feature a factory-installed hard disk drive.

9 Image

The Image menu, which consists of seven functions (9.1 through 9.7), is valid only on 1x1 DVD Duplicator systems that feature a factory-installed hard disk drive. The Image menu includes Load, Delete Image, Image Info, Compare Image, Select Image, Image Src Drive, and Image Format Info functions. The data loaded onto the hard disk drive is called an “image file.”

9.1 Load

The factory-installed hard disk drive was partitioned and formatted at the factory. An alphabetical letter identifies each partition. Each partition is approximately 5GB in capacity. The number of partitions depends on the capacity of the hard disk drive. The Load function enables you to transfer data from the DVD-ROM drive or any DVD Writer drive to the current partition of the hard disk drive. (Note: P:A stands for partition A.) You can load as many disc images as the number of partitions available on the hard disk drive.

9.2 Delete Image

Use the Delete Image function to delete an image stored in a particular partition.

9.3 Image Info

Use the Image Info function to display basic information for an image file stored in a particular partition.

9.4 Compare Image

Use the Compare Image function to compare the contents of a source DVD-ROM disc with the image file in the partition.

9.5 Select Image

The internal hard disk drive was partitioned and formatted at the factory. An alphabetical letter identifies each partition. Each partition is approximately 5GB in capacity. The number of partitions depends on the capacity of the hard disk drive. Use the Select Image function to select an image file that is stored in a specific partition on the hard disk drive.

9.6 Image Src Drive

Use the Image Src Drive function to select the DVD-ROM drive or the DVD Writer drive as the source from which you can load data into a particular partition as an image file.

9.7 Image Format Info

The partitions on the hard disk drive can be configured to store a CD (1GB), DVD (5GB), or a Double Layer (DL) (10GB) image. The factory partitions the hard disc drive for DVD images at (5GB per partition). Use the Image Format Info function to verify this setting.

10. Edit Track (for CD only)

The Edit Track functions enable you to create and copy a collection of songs from different audio discs.

***Note:** The CD+G value must be set to OFF before you can use the Track Extraction feature. For more information, refer to “12 Advanced Setup (Adv Setup)” on page 19.*

10.1 CD to CD Edit

The CD to CD Edit function enables you to select specific tracks from various audio discs, combine them to create a collection of songs, and copy the collection to blank CD-R/CD-RW discs.

***Note:** CD-R discs support up to 80 minutes of audio. Therefore, the number of tracks that can be copied onto a single disc depends on the length of each individual track.*

10.2 CD to HDD



The CD to HDD function enables you to select one or more tracks from an audio CD-ROM disc and copy them to a specific partition on the hard disk drive.

***Note:** CD-R discs support up to 80 minutes of audio. Therefore, the number of tracks that can be copied onto a single disc depends on the length of each individual track.*

10.3 Play Audio Track

This function enables you to use the designated source drive as a music CD player.

If the DVD-ROM drive does not feature a headphone jack, change the source drive designation to the DVD-RW drive using function [8 Select Source] (see page 14.)

You can connect standard multimedia speakers to the audio jack of the designated source drive. The volume knob on the front of the drive controls the audio volume level. The arrow buttons   on the LCD panel enable you to skip to the next track (forward or back).

10.4 Close Session

This function finalizes your CD-R disc. Once the CD-R disc is finalized, no more audio can be added to that disc.

11 Setup

The Setup menu includes a list of options that enable you to change the original default configuration. Various settings are available under the Setup menu that control the operation of the DVD Duplicator. However, TEAC recommends that you use the original default settings for optimal operation.

11.1 Language

The DVD Duplicator LCD panel can display text in English and Spanish. The Language function enables you to select the display language. English is the default option.

11.2 CD Burn Speed

The CD Burn Speed setting controls the writing speed of the target drive when recording onto CD-R/CD-RW media. The default value is **MAXIMUM**, which writes at the highest speed available on the target drive.

11.3 DVD Burn Speed

The DVD Burn Speed setting controls the writing speed of the target drive when recording onto DVD±RW media. The default value is **MAXIMUM**, which writes at the highest speed available on the target drive. On occasion, using the maximum writing speed will cause copy failure due to poor quality DVD±RW discs. In this case, TEAC recommends that you reduce the writing speed.

11.4 Read Speed

The Read Speed function enables you to set the reading speed of the target drive. **MAXIMUM** is the default setting.

11.5 Auto Start Drive

The Auto Start Drive setting enables the DVD Duplicator to auto-start the copy or test process as soon as a blank disc is inserted into the target drive. The default setting is **OFF**.

11.6 Startup Menu

The Startup Menu setting enables you to select a menu item to be displayed as the first menu item when you turn on the DVD Duplicator. COPY is the default.

11.7 Auto Verify

The Auto Verify setting controls auto verification of discs after a copy operation. The default setting is OFF.

11.8 Auto Compare

The Auto Compare setting controls auto-comparison of data between source and target discs after a copy operation. The default setting is OFF.

11.9 Auto Prescan

The Auto Prescan setting controls automatic prescan of the source disc whenever a data/audio disc is inserted in the source drive. The default setting is OFF.

11.10 Eject Disc

The Eject Disc setting controls the ejection of discs by the target drive. Three options are available:

- Eject Good Only – This option ejects the disc only if it has been successfully copied. This is the default setting
 - Eject All Disc – This option ejects the disc regardless of whether the copy was successful or failed.
 - Do Not Eject – With this option, the disc remains in the target drive. Manual ejection is required after every copy operation.
-

11.11 Burn on the Fly

The Burn on the Fly function enables you to control the copy operation. When the setting is ON, data is copied directly from the source DVD to the target DVD. When the setting is OFF, the DVD Duplicator first loads the data into a partition on the hard disk drive, then copies the data to the target DVD.

This function is valid only on DVD Duplicators that feature an internal hard disk drive.

11.12 Burn Mode

The Burn Mode setting enables you to select from two writing methods for CD-R media:

- Disc At Once (DAO)
- Track At Once (TAO)

DAO is the default setting.

11.13 Display Time

The Display Time function displays the total time of each copy operation. The default setting is OFF.

11.14 Button Sound

The Button Sound setting turns the button sound on or off. The default setting is ON.

11.15 Device Info

The Device Info function displays information for both the source and target drives.

11.16 System Info

The System Info function displays information for the interface board.

11.17 Quick Erase

The Quick Erase function performs a Quick Erase on DVD-RW discs.

11.18 Full Erase

The Full Erase function performs a Full Erase on DVD-RW discs. This function takes longer than the Quick Erase.

12 Advanced Setup (Adv Setup)

The Advanced Setup functions enable you to modify the system configuration. You should make changes only after you become completely familiar with the functions in this menu. To enter Advanced Setup mode, press the ESC button for two (2) seconds.

12.1 UnderRun Protect

The UnderRun Protect setting turns Buffer UnderRun Protection on or off. The default setting is ON.

12.2 Overburn

The Overburn setting turns the Overburn function in the target drive on or off. The default setting is OFF.

12.3 Read Error Skip

The Read Error Skip setting controls error skipping during reading of the source disc.

If the setting is OFF and an error is detected, the target drive stops and displays the read error message.

If the setting is ON, no messages will be displayed if an error occurs. The copy operation will be completed and the copy will include all errors detected during the process.

The default setting is OFF.

12.4 Format HDD

(For factory use only; please do NOT use this function.)

Warning! Do not run this function. It will erase all data already loaded into disk partitions. This function is reserved for factory use only.

The Format HDD option is valid only on DVD Duplicators that feature a factory-installed hard disk drive. The factory-installed hard disk drive has already been partitioned and formatted and is ready for use.

12.5 Verify HDD

(For factory use only; please do NOT use this function.)

Warning! Do not run this function. It will erase all data already loaded into disk partitions. This function is reserved for factory use only.

The Verify HDD option is valid only on DVD Duplicators that feature a factory-installed hard disk drive. The factory-installed hard disk drive has already been partitioned and formatted and is ready for use.

12.6 Burn-in

The Burn-in function runs an emulate writer function continuously. The disc in the target drive is ejected and re-inserted automatically between each test cycle. This function can be prepared to run continuously or specified to run from 1 to 1000 times.

12.7 Update Firmware

The Update Firmware function updates the firmware of the interface board via CD or DVD disc. The disc must contain the required data file and be inserted in the source drive. The DVD Duplicator will locate the data and update its firmware automatically. During the update, do not turn off the power to the unit. The update process is complete after the system resets automatically and displays the main menu.

12.8 Compare Firmware

The Compare Firmware function compares the current firmware version in the interface board to the update version in the disc.

12.9 H/W Diagnostic

The H/W Diagnostic function detects the devices connected to the interface board, confirms functionality, and displays information about the hardware on the LCD.

12.10 Load Default

The Load Default function resets all settings to factory default values. It is recommended that you reset to the default values if the DVD Duplicator fails to function properly after you make changes to the original configuration.

12.11 CD+G

The CD+G function enables or disables CD+G (karaoke CD) format support. The default setting is OFF.

Note: The CD+G value must be set to OFF before you can use the Track Extraction features.

12.12 ISRC & MCN

The ISRC & MCN function enables or disables ISRC and MCN format support. The default setting is OFF.

12.13 CD-Text

The CD-Text function enables or disables the copying of CD-Text discs. The default setting is OFF.

12.14 Switch USB Mode

The Switch USB Mode function is not applicable to TEAC DVD Duplicators.

Appendix A. List of Functions

- 1 Copy
- 2 Test
- 3 Test & Copy
- 4 Verify
- 5 Compare
- 6 Prescan
- 7 Disc Info
- 8 Select Source

- 9 Image (available only on DVW-D11H)
 - 9.1 Load
 - 9.2 Delete Image
 - 9.3 Image Info
 - 9.4 Compare Image
 - 9.5 Select Image
 - 9.6 Image Src Drive
 - 9.7 Image Format Info

- 10 Edit Track (for CD only)
 - 10.1 CD to CD Edit
 - 10.2 CD to HDD (available only on DVW-D11H)
 - 10.3 Play Audio Track
 - 10.4 Close Session

- 11 Setup
 - 11.1 Language (Default is English.)
 - 11.2 CD Burn Speed (Default is Maximum.)
 - 11.3 DVD Burn Speed (Default is Maximum.)
 - 11.4 Read Speed (Default is Maximum.)
 - 11.5 Auto Start Drive (Default is Off.)
 - 11.6 Startup Menu (Default is Copy.)
 - 11.7 Auto Verify (Default is Off.)
 - 11.8 Auto Compare (Default is Off.)
 - 11.9 Auto Prescan (Default is Off.)
 - 11.10 Eject Disc (Default is Eject Good Only.)
 - 11.11 Burn on the Fly (Default is On.)
 - 11.12 Burn Mode (Default is DAO.)
 - 11.13 Display Time (Default Off.)
 - 11.14 Button Sound (Default is On.)
 - 11.15 Device Info
 - 11.16 System Info
 - 11.17 Quick Erase
 - 11.18 Full Erase

- 12 Advanced Setup (Adv Setup)
 - 12.1 UnderRun Protect (Default is On)
 - 12.2 Overburn (Default is Off)
 - 12.3 Read Error Skip (Default is Off)
 - 12.4 Format HDD (factory use only)
 - 12.5 Verify HDD (factory use only)
 - 12.6 Burn-in
 - 12.7 Update Firmware
 - 12.8 Compare Firmware
 - 12.9 H/W Diagnostic
 - 12.10 Load Default
 - 12.11 CD+G (Default is Off)
 - 12.12 ISRC & MCN (Default is Off)
 - 12.13 CD-Text (Default is Off)
 - 12.14 Switch USB Mode (n/a)

Appendix B. LCD Messages

This appendix explains the messages that may appear on the LCD panel.

Normal Conditions (for both DVD Duplicator models)

Message	Meaning
Initialize SDRAM	Initialize system memory.
Detect drives	Detect the drives connected to the system.
User Abort	Cancel a job during operation.
Analyzing	Analyze the source disc.
Source Drive Not Ready	Source drive is not ready to read.
Target Drive Not Ready	Target drive is not ready to write.
Erasing disc	The system is erasing the data on the disc.
Source Disc Not Ready	Source disc is not ready to be read.
Target Disc Not Ready	Target disc is not ready to be written into.
Fail to get Drive Info!	Drive information cannot be obtained.
Fail to get SRC Disc Info!	Information about a source disc cannot be obtained.
Save new config Fail!	The new configuration settings cannot be saved.
Load Default Config?	Do you want to load the default settings?
Src&Tgt can't in the same channel	During comparison, the source and target discs cannot occupy the same channel.
Preparing	The system is preparing to record.
Check Target Please Wait	The system is checking the target device.
Audio Disc!!!Can't compare!	The system cannot compare the audio disc.
Identical	Comparison results are identical.
Read disc error	During a comparison, the disc could not be read.
Cannot read TOC	The system cannot read the contents of the disc.
TOC not match	Comparison results are not identical.
Source Disc Empty!!!	The source disc contains no data.
Target overflow	The target disc capacity is insufficient to store new data.
Target Disc Not Empty!!!	The target disc still contains data.
Press a Key to Eject Good Disc	Press any key to eject a disc after copying. (Copy successful.)
Press a key to Eject Fail Disc	Press any key to eject a disc after copying. (Copy failed.)
DVD-RW does not Support the Func	DVD-RW does not support this function.
Hold ESC to exit	Press ESC for one second to terminate the test.
All data will be lost, erase?	All data on the disc will be lost. Confirm erasure request.
Erase Finished	The erasing of the data is complete.
No Erasable Disc in DVD-RW!!	The disc in the DVD-RW drive is not rewritable.

Normal Conditions (for the model that features a hard disk drive)

Message	Meaning
HDD not Format!	The hard disk has not been formatted.
Format HDD?	Do you want to format the hard disk?
All data will be lost, format?	All data on the hard disk will be lost. Confirm the format request.
Format HDD OK!	Formatting of the hard disk is complete.
Image load OK	The image has been successfully loaded from DVD to the hard disk.
Image load Fail	The image has not been loaded successfully from DVD to the hard disk.
HDD too small to handle image!	The hard disk capacity is insufficient to store the data image (at least 5Gbytes is required).
No Valid HDD!	The system cannot locate a hard disk.
HDD too small	The hard disk capacity is too small.
No Image in Partition xx	There is no data image in the specified partition.
Image Exists Overwrite?	The current partition contains a data image. Confirm the overwriting request.
Delete Image in Partition xx?	Confirm the request to delete the data image in the specified partition.
Partition Damage	The partition is damaged.
Verify Disk Or Partition?	Do you want to verify the entire hard disk or only a partition?
Verify Hard Disk OK!	The hard disk has been verified successfully.
Verify the Hard Disk Fail!	The hard disk has not been verified successfully.
Verify Partition Header!	Verify the partition header.
Select HDD First!	First select a formatted hard disk.

Audio Editing

Message	Meaning
Lost selected Tracks?	Abort and delete the selected tracks.
End edit disc and burn?	Finish the music disc editing and start to copy.
Continue edit next Disc?	Do you want to continue the music disc editing?
Target Overflow Re-Select	The disc capacity is insufficient to store the selected tracks. Please select fewer tracks.
Close all disc's session?	Confirm the closing of disc sessions.
Can't edit HDD	The hard disk cannot be edited as a source audio disc.
NO AUDIO track in this disc	The source disc contains no audio tracks.
INSERT next disc	Insert the next audio disc.
Sessions were closed already!	The disc sessions have already been closed.
Burn or Move to partition?	Do you want to copy the data directly to disc or transfer the data to a hard disk partition?
Tgt overflow, del last trk?	Disc capacity is insufficient to store the selected tracks. Do you want to delete the last track?
Ins empty disc Continue?	Do you want to insert a blank disc and continue copying?

Appendix C. About DVD-R and DVD-RW Discs

This appendix explains how to handle, load, and eject DVD-R and DVD-RW discs.

Handling Discs

- ❑ Handle compact discs only by their edges to avoid getting fingerprints on the surface. Do not touch the disc's data surface (unlabeled side).
- ❑ Do not place discs in direct sunlight or in locations subject to high humidity, high temperatures, or dusty conditions.
- ❑ If it becomes necessary to clean a disc due to erratic operation, visible dust, or smudges, gently wipe the surface of the disc from the center to the outside edge. Do not use benzene, alcohol, thinner, or other solvents.

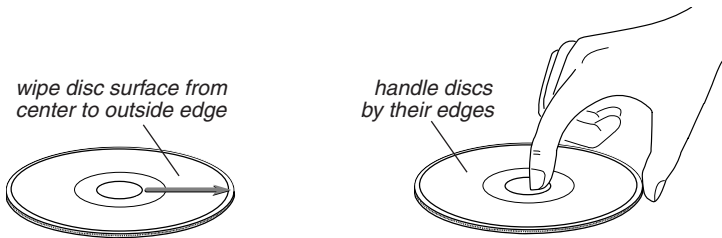

Figure 6. How to Handle Compact Discs (DVD-R and DVD-RW)

Loading and Ejecting Discs

To load a disc into the source or a target drive, first open the disc tray by pressing the Eject button on the front of the drive. Place the disc on the disc tray with its label side facing up. Then press the Eject button again to retract the disc tray back into the drive.

To eject a disc from the source or a target drive, press the Eject button on the front of the drive to extend the disc tray. Remove the disc from the disc tray and place it in its protective case. Then press the Eject button again to retract the disc tray back into the drive.

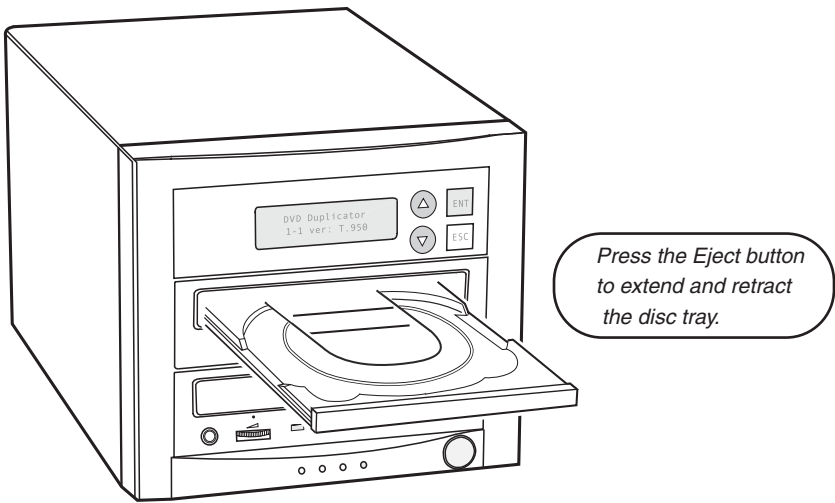

Figure 7. Ejecting the Disc Tray

Appendix D. Specifications

The following table lists the product specifications for the TEAC DVD Duplicator.

Model	DVW-D11	DVW-D11H
HDD Capacity	None	80GB
Weight	11.65 lbs.	13.15 lbs.
Dimensions (HxWxD)	6.7" x 7.5" x 17.2"	
DVD Recorder	TEAC 16X DVD-RW	
Drive Interface	IDE / ATAPI	
Read Speed	DVD: 16x; CD: 48x	
Write Speed	DVD: 16x; CD: 48x	
Drive Buffer Size	2MB	
System Buffer Size	8MB	
Supported Discs	DVD+R, DVD+RW, DVD+DL, DVD-R, DVD-RW, CD-R, and CD-RW discs	
System Control	Copy and Search Buttons	
System Display	LCD Panel; LED Indicators	
Write Method	Auto Detect (DAO, TAO)	
Operation Mode	Copy, Test, Scan, Compare	
Firmware Upgrade	Via CD-ROM/DVD-ROM	
Power Supply	AC Input: 100 - 240V	

Appendix E. Technical Support and Warranty

For technical support, please contact the TEAC America Support Center

TEAC America, Inc. (USA)

Technical Support

Telephone: (323) 727-4860 • Fax: (323) 869-8751

Monday - Friday 8:00 a.m. - 5:00 pm PST

<http://www.teac.com/DSPD/techsupport-America.htm>

E-mail: dspdtsg@teac.com

Limited Warranty

This product is warranted by TEAC America, Inc. against defects in materials and workmanship.

LENGTH OF WARRANTY – This warranty will be effective for both labor and parts, and this warranty will be effective for one (1) year from the date of original purchase.

WHO MAY ENFORCE THE WARRANTY - This warranty is valid only in the United States, and enforceable only by the original purchaser. This warranty is not valid outside the United States.

WHAT IS NOT COVERED BY THIS WARRANTY

1. Damage to or deterioration of the external cabinet.
2. Damage resulting from accident, misuse, abuse, or neglect.
3. Damage resulting from failure to follow instructions contained in your user's manual.
4. Damage occurring during shipment of the product (claims must be presented to the carrier).
5. Damage resulting from repair or attempted repair by anyone other than TEAC Service Department.
6. Damage resulting from modification or attempted modification of product not authorized by TEAC.
7. Damage resulting from causes other than product defects, including lack of technical skill, competence, or experience of the user.
8. Damage to any unit that has been altered or on which the serial number has been defaced, modified or removed.
9. Damage or malfunction resulting from installation and cabling.
10. For wireless configurations, TEAC cannot be responsible for interference or operation in locations that restrict range.
11. Damage to or from interconnected network equipment.
12. Data integrity or loss of data.

HOW YOU CAN GET WARRANTY SERVICE – Please contact the TEAC service department for a Return Authorization number before shipping unit(s) to TEAC. Information required for R/A request should include your name and/or company name, telephone number, TEAC model, version and serial number(s). Return Authorization (R/A) number must be clearly marked on the outside of each carton shipped to TEAC. Return merchandise must be packed in original shipping containers or otherwise packed adequately to prevent damage in shipment. You are responsible for all risk of damage to or loss of merchandise in transit to TEAC. TEAC reserves the right to reject any merchandise that is not packaged and/or marked as instructed herein. You must pay any shipping charges if it is necessary to ship the product for service. However, if the necessary repairs are covered by the warranty, we will pay the return shipping charges to any destination within the United States. Whenever warranty service is required, you must present a copy of the original dated sales receipt as proof of warranty coverage. Please contact us at the addresses listed at the end of this warranty statement.

WHAT TEAC WILL PAY FOR – We will pay all labor and material expenses for items covered by the warranty. Payment of shipping charges is discussed in the next section of this warranty.

LIMITATION OF IMPLIED WARRANTIES

ANY IMPLIED WARRANTIES, INCLUDING WARRANTIES OF MERCHANTABILITY AND FITNESS FOR A PARTICULAR PURPOSE, ARE LIMITED IN DURATION TO THE LENGTH OF THIS WARRANTY.

EXCLUSION OF DAMAGES

TEAC'S LIABILITY FOR ANY DEFECTIVE PRODUCT IS LIMITED TO REPAIR OR REPLACEMENT OF THE PRODUCT, AT TEAC'S OPTION. TEAC SHALL NOT BE LIABLE FOR DAMAGES BASED UPON INCONVENIENCE, LOSS OF USE OF THE PRODUCT, LOSS OF TIME, INTERRUPTED OPERATION OR COMMERCIAL LOSS, LOST PROFITS OR ANY OTHER DAMAGES, WHETHER INCIDENTAL, CONSEQUENTIAL, PUNITIVE OR OTHERWISE.

SOME STATES DO NOT ALLOW LIMITATIONS ON HOW LONG AN IMPLIED WARRANTY LASTS AND/ OR DO NOT ALLOW THE EXCLUSION OR LIMITATION OF INCIDENTAL OR CONSEQUENTIAL DAMAGES, SO THE ABOVE LIMITATIONS AND EXCLUSIONS MAY NOT APPLY TO YOU.

THIS WARRANTY GIVES YOU SPECIFIC RIGHTS, AND MAY VARY FROM SOME OF THE RIGHTS PROVIDED BY LAW. THESE RIGHTS MAY VARY FROM STATE TO STATE.

To contact the TEAC Service Center in the United States:

Tel: 1-323-727-7694 or 1-323-727-7616

Fax: 1-323-727-7606

E-mail: dssvce@teac.com

TEAC America, Inc.

7733 Telegraph Road

Montebello, California 90640