

# TASCAM<sup>®</sup>

TEAC PROFESSIONAL

D01068520A

# DR-100

## Portable Digital Recorder

### OWNER'S MANUAL

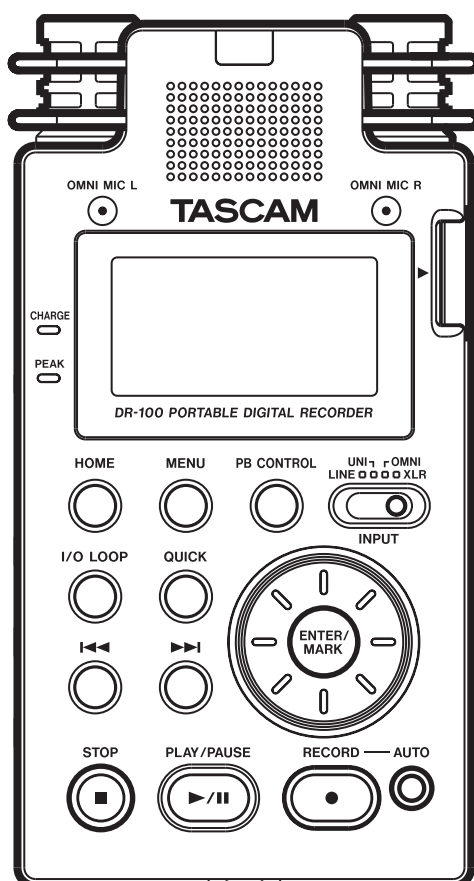

# IMPORTANT SAFETY PRECAUTIONS



**CAUTION**  
RISK OF ELECTRIC SHOCK  
DO NOT OPEN



**CAUTION: TO REDUCE THE RISK OF ELECTRIC SHOCK, DO NOT REMOVE COVER (OR BACK). NO USER-SERVICEABLE PARTS INSIDE. REFER SERVICING TO QUALIFIED SERVICE PERSONNEL.**



The lightning flash with arrowhead symbol, within equilateral triangle, is intended to alert the user to the presence of uninsulated "dangerous voltage" within the product's enclosure that may be of sufficient magnitude to constitute a risk of electric shock to persons.



The exclamation point within an equilateral triangle is intended to alert the user to the presence of important operating and maintenance (servicing) instructions in the literature accompanying the appliance.

— For U.S.A. —

## TO THE USER

This equipment has been tested and found to comply with the limits for a Class B digital device, pursuant to Part 15 of the FCC Rules. These limits are designed to provide reasonable protection against harmful interference in a residential installation. This equipment generates, uses, and can radiate radio frequency energy and, if not installed and used in accordance with the instruction manual, may cause harmful interference to radio communications. However, there is no guarantee that interference will not occur in a particular installation. If this equipment does cause harmful interference to radio or television reception, which can be determined by turning the equipment off and on, the user is encouraged to try to correct the interference by one or more of the following measures.

- a) Reorient or relocate the receiving antenna.
- b) Increase the separation between the equipment and receiver.
- c) Connect the equipment into an outlet on a circuit different from that to which the receiver is connected.
- d) Consult the dealer or an experienced radio/TV technician for help.

## CAUTION

Changes or modifications to this equipment not expressly approved by TEAC Corporation for compliance could void the user's authority to operate this equipment.

This appliance has a serial number located on the rear panel. Please record the model number and serial number and retain them for your records.

Model number \_\_\_\_\_

Serial number \_\_\_\_\_

**WARNING: TO PREVENT FIRE OR SHOCK HAZARD, DO NOT EXPOSE THIS APPLIANCE TO RAIN OR MOISTURE.**

## Declaration of Conformity

Model Number : DR-100  
Trade Name : TASCAM  
Responsible party : TEAC AMERICA, INC.  
Address : 7733 Telegraph Road, Montebello,  
California, U.S. A.  
Telephone number: 1-323-726-0303

This device complies with Part 15 of the FCC Rules. Operation is subject to the following two conditions:  
(1) this device may not cause harmful interference, and  
(2) this device must accept any interference received, including interference that may cause undesired operation.

# IMPORTANT SAFETY INSTRUCTIONS

- 1 Read these instructions.
  - 2 Keep these instructions.
  - 3 Heed all warnings.
  - 4 Follow all instructions.
  - 5 Do not use this apparatus near water.
  - 6 Clean only with dry cloth.
  - 7 Do not block any ventilation openings. Install in accordance with the manufacturer's instructions.
  - 8 Do not install near any heat sources such as radiators, heat registers, stoves, or other apparatus (including amplifiers) that produce heat.
  - 9 Do not defeat the safety purpose of the polarized or grounding-type plug. A polarized plug has two blades with one wider than the other. A grounding type plug has two blades and a third grounding prong. The wide blade or the third prong are provided for your safety. If the provided plug does not fit into your outlet, consult an electrician for replacement of the obsolete outlet.
  - 10 Protect the power cord from being walked on or pinched particularly at plugs, convenience receptacles, and the point where they exit from the apparatus.
  - 11 Only use attachments/accessories specified by the manufacturer.
  - 12 Use only with the cart, stand, tripod, bracket, or table specified by the manufacturer, or sold with the apparatus. When a cart is used, use caution when moving the cart/apparatus combination to avoid injury from tip-over.
- Do not expose this apparatus to drips or splashes.
  - Do not place any objects filled with liquids, such as vases, on the apparatus.
  - Do not install this apparatus in a confined space such as a book case or similar unit.
  - The apparatus draws nominal non-operating power from the AC outlet with its POWER or STANDBY/ON switch not in the ON position.
  - The apparatus should be located close enough to the AC outlet so that you can easily grasp the power cord plug at any time.
  - The mains plug is used as the disconnect device, the disconnect device shall remain readily operable.
  - An apparatus with Class I construction shall be connected to an AC outlet with a protective grounding connection.
  - Batteries (battery pack or batteries installed) should not be exposed to excessive heat such as sunshine, fire or the like.
  - CAUTION: Danger of explosion if battery is incorrectly replaced. Replace only with the same or equivalent type.
  - Excessive sound pressure from earphones and headphones can cause hearing loss.



- 13 Unplug this apparatus during lightning storms or when unused for long periods of time.
- 14 Refer all servicing to qualified service personnel. Servicing is required when the apparatus has been damaged in any way, such as power-supply cord or plug is damaged, liquid has been spilled or objects have fallen into the apparatus, the apparatus has been exposed to rain or moisture, does not operate normally, or has been dropped.

# IMPORTANT SAFETY PRECAUTIONS

## Cautions about rechargeable batteries

This product uses rechargeable batteries. Misuse of batteries could cause a leak, rupture or other trouble. Always abide by the following precautions when using batteries.

- If a rechargeable battery leaks, do not touch the leaking fluid with a bare hand. Please consult with TEAC Corporation if a battery fluid leak occurs.
- Battery fluid in an eye could result in loss of vision. If fluid enters an eye, wash the eye immediately with clean water. Do not rub the eye when washing. Consult a physician soon after washing. Battery fluid on the body or clothing could cause injuries or burns on the skin. Wash with clean water immediately and then consult a physician.
- Do not use any AC adapter other than the model designated for use with this unit. Always use the designated AC adapter when operating the unit or recharging the battery with a household AC power source. Use of an AC adapter other than the designated one could lead to overheating and cause injury, burns, fires or stains, as well as battery ruptures and battery fluid leaks.
- Do not put a battery into a fire or leave it or recharge it near a fire, under the sun or in other hot conditions.
- Do not disassemble a battery. Doing so could cause electric shock. Please contact the shop where you bought the product or TEAC Corporation if you want to have a battery inspected or repaired. When you want to dispose of the product, please follow the instruction in the Owner's Manual to remove the batteries and recycle the equipment properly.

## Cautions about batteries

- Never recharge non-rechargeable batteries. The batteries could rupture or leak, causing fire or injury.
- When installing batteries, pay attention to the polarity indications (plus/minus (+/-) orientation), and install them correctly in the battery compartment as indicated. Putting them in backward could

make the batteries rupture or leak, causing fire, injury or stains around them.

- When you store or dispose batteries, isolate their terminals with insulation tape or something like that to prevent them from contacting other batteries or metallic objects.
- When throwing used batteries away, follow the disposal instructions indicated on the batteries and the local disposal laws.
- Small children may mistakenly swallow a lithium coin battery and it is very dangerous. Keep the battery and the remote control out of the reach of small children. In the event a battery is swallowed, immediately consult a physician.
- Do not use batteries other than those specified. Do not mix and use new and old batteries or different types of batteries together. The batteries could rupture or leak, causing fire, injury or stains around them.
- Do not carry or store batteries together with small metal objects. The batteries could short, causing leak, rupture or other trouble.
- Do not heat or disassemble batteries. Do not put them in fire or water. Batteries could rupture or leak, causing fire, injury or stains around them.
- If the battery fluid leaks, wipe away any fluid on the battery case before inserting new batteries. If the battery fluid gets in an eye, it could cause loss of eyesight. If fluid does enter an eye, wash it out thoroughly with clean water without rubbing the eye and then consult a doctor immediately. If the fluid gets on a person's body or clothing, it could cause skin injuries or burns. If this should happen, wash it off with clean water and then consult a doctor immediately.
- Remove the batteries if you do not plan to use the unit for a long time. Batteries could rupture or leak, causing fire, injury or stains around them. If the battery fluid leaks, wipe away any fluid on the battery compartment before inserting new batteries.
- Do not disassemble a battery. The acid inside the battery could harm skin or clothing.

## 产品有毒有害物质或元素的名称及含量

机种: DR-100		有毒有害物质或元素					
	品名	铅 (Pb)	汞 (Hg)	镉 (Cd)	六价铬 (Cr(VI))	多溴联苯 (PBB)	多溴二苯醚 (PBDE)
1	CHASSIS部份	○	○	○	○	○	○
2	PCB Assy部份	×	○	○	○	○	○
3	线材部份	○	○	○	○	○	○
4	附属品部份	×	○	○	○	○	○
5	SEAL部份	○	○	○	○	○	○
6	包装部份	○	○	○	○	○	○
7	Battery部份	○	○	○	○	○	○

○: 表示该有毒有害物质在该部件所有均质材料中的含量均在 SJ/T11363-2006 标准规定的限量要求以下。

×: 表示该有毒有害物质至少在该部件的某一均质材料中的含量超出 SJ/T11363-2006 标准规定的限量要求。

(针对现在代替技术困难的电子部品及合金中的铅)

<b>1–Introduction</b> .....	7
Main features.....	7
Included items .....	7
Conventions used in this manual.....	7
Recycling the lithium ion battery.....	8
Trademarks, copyrights, and disclaimers .....	8
SD cards.....	9
Precautions for use.....	9
Beware of condensation .....	9
Cleaning the unit.....	9
<b>2–Quick Start Guide</b> .....	10
Turn the power on.....	10
Prepare to record .....	11
Start and stop recording .....	11
Play and stop playback.....	12
Turn the power off .....	12
<b>3–Names and Functions of Parts</b> .....	13
Top Panel.....	13
Right side panel.....	14
Left side panel .....	14
Front panel.....	14
Rear panel.....	15
Bottom panel.....	15
Remote control (RC-DR100).....	16
<b>4–Preparation for Use</b> .....	17
Using with batteries .....	17
Using the lithium ion battery.....	17
Charging the lithium ion battery .....	17
Using AA batteries .....	17
Using both types of batteries together.....	18
Using an AC adapter (sold separately) .....	18
Preparing the remote control.....	18
Installing the battery .....	18
When to change the battery .....	18
Cautions about the use of the battery.....	18
Using the remote control .....	19
Wireless use .....	19
Wired use .....	19
Precautions for use of the remote control.....	19
Turning the power on and off .....	20
Battery settings.....	20
Inserting and removing SD cards.....	20
Preparing an SD card for use.....	20
Card write protection.....	21
Setting the date and time .....	21
Using the built-in speaker .....	21
Connecting monitors and headphones.....	21
<b>5–Screens and Operation Basics</b> .....	22
Home Screen.....	22
Recording screen.....	23
Using menus .....	23
Basic operation.....	24
<b>6–Recording</b> .....	25
Preparing with the REC SETTING menu .....	25
Available recording time display.....	25
Setting the input .....	25
Recording with the built-in mics (UNI/OMNI).....	25
Recording with external mics (XLR).....	26
Recording an external device (LINE).....	26
Set where to save the file .....	26
Adjusting the input level.....	27
MIC GAIN.....	27
Recording .....	27
Stop recording .....	27
Pause recording.....	27
Dividing files and creating new files while recording.....	28
Creating new files manually while recording (track incrementing) .....	28
Creating new files automatically while recording (automatic track incrementing) .....	28
Automatically cutting silences during recording.....	28
Dividing a file manually (DIVIDE).....	28
Automatic recording (AUTO REC).....	29
Enabling automatic recording .....	29
Automatically adding marks when recording (MARK).....	29
Automatically pausing recording (PAUSE).....	30
Start new files automatically during recording (TRK INC).....	30
Mark function .....	30
Adding marks manually to a recording.....	30
Moving to a mark position.....	30
Recording the moment before pushing RECORD (PRE REC).....	31
Delaying the start of recording (REC DELAY) .....	31
Recording playback and input sounds together (overdubbing) .....	31
Adjust the levels of the input and playback sounds .....	31
Recording an overdub.....	32
Stop overdubbing .....	32
Recording time .....	32
<b>7–Playback</b> .....	33
Selecting files for playback (skip).....	33
Playback (PLAY) .....	33
Stopping (STOP).....	33
Pausing (PAUSE).....	33
Rewinding and fast-forwarding (search).....	33
Using the wheel to change the playback position .....	33
Repeat playback (REPEAT) .....	33
Setting the playback area (AREA) .....	34
Adding files to the playlist (PLAYLIST) .....	34
Working with the playlist.....	34
Changing the playlist order (MOVE).....	35
Delete files from the playlist (DELETE).....	35
Clear the entire playlist (ALL CLR).....	35
Play files in the playlist (PLAY) .....	35
Loop playback (I/O LOOP) .....	36
Adjusting the playback speed (PB CONTROL).....	36
Adjusting the playback volume.....	36

# Contents

<b>8–Connecting with a Computer</b> .....	37
Connecting a computer .....	37
Transferring files to a computer .....	37
Transferring files from a computer .....	37
Disconnecting from a computer .....	37
<b>9–Working with Files and Folders</b> .....	38
Showing files inside folders .....	38
Working with folders .....	38
Working with files .....	39
Add identification tags to files (QUICK TAG) .....	39
Delete the selected playback file (QUICK DEL) .....	39
<b>10–Settings and Information</b> .....	40
Using the INFORMATION screens .....	40
File information (FILE) .....	40
Card information (CARD) .....	40
System information (SYSTEM) .....	40
Battery information (BATTERY) .....	41
Using input monitoring (MONITOR) .....	41
Setting mono input (TYPE) .....	41
Using the low cut filter (LOW CUT) .....	41
Using the auto gain control and limiter (LABEL CTRL) .....	42
Auto gain control (AUTO) .....	42
Limiter (LMT) .....	42
Adjusting the playback level (MIX BALANCE) .....	42
Setting the file name format .....	42
File name format .....	42
Setting the file name (WORD) .....	43
Setting the search speed (CUE/REV SPEED) .....	43
Turning the power off automatically (AUTO OFF) .....	43
Turning the backlight off automatically (BACKLIGHT) .....	43
Adjusting the contrast (CONTRAST) .....	43
Setting the brightness of the backlight (DIMMER) ..	44
Restoring default settings (INITIALIZE) .....	44
Formatting the SD card .....	44
Setting the main battery source (MAIN) .....	44
Changing batteries when the power is on .....	45
Changing the main battery .....	45
Changing the backup battery .....	45
Setting the type of AA batteries (AA BATTERY) .....	45
Menu item list .....	46
List of popup menu items .....	47
<b>11–Messages</b> .....	48
<b>12–Specifications</b> .....	50
Audio input ratings .....	50
Audio performance .....	50
Accessory (sold separately) .....	50
Requirements for connected computers .....	50
Dimensional drawing .....	51

Thank you very much for purchasing a TASCAM DR-100 Portable Digital Recorder. Before using your unit, please read this manual carefully so that you will understand the correct operating procedures and be able to use all the functions fully. We hope that you will enjoy using this product for many years to come.

Please keep this manual for future reference. You can also download a digital copy from our website (<http://www.tascam.com/>).

---

## Main features

---

This portable recorder uses SD memory cards to make high quality recordings. Key features of this unit include the following.

- Record in MP3 or linear PCM WAV (16 or 24 bit, 44.1 or 48 kHz) audio file format
- 4 built-in mics include 2 directional mics suitable for recording in high-quality stereo and 2 omnidirectional mics that optimal for recording meetings and similar events
- 2 XLR mic connectors that can provide +48 V phantom power
- Built-in 0.4-W mono speaker
- 2 different types of batteries used together allow for many hours of operation as well as the ability to change batteries while recording
- AUTO REC function allows the unit to start and stop recording automatically by sensing changes in the input level
- MARK function allows you to set and move to locations in a recording
- DIVIDE function allows you to split a file at the position you select
- PRE REC function allows the unit to record the two seconds of sound before recording is activated (pre-recording)
- User words and dates can be set for file names
- Quick Tag function allows you to quickly identify files
- REC DELAY allows you to avoid recording the sound of pushing the **RECORD** [●] key
- Automatic track incrementing creates a new file and continues recording when a file size or input level set in advance is exceeded
- Track incrementing allows the creation of new files at any time during recording without pausing
- Tripod mounting hole built-in
- Wireless remote control (RC-DR100) included with wired remote control adapter and cable

- Soft case and windscreen included

---

## Included items

---

This product includes the following items. If any of the accessories are missing or appear to have been damaged during transportation, please contact TEAC Corporation.

- Main unit ..... 1
- SD memory card (installed in the main unit) ..... 1
- BP-L2 (custom lithium ion battery) ..... 1 (including warranty and manual)
- USB cable ..... 1
- Soft case ..... 1
- Windscreen ..... 1
- Wireless remote control (RC-DR100) ..... 1
- Coin battery for remote control (CR2025) ..... 1
- Wired remote control adapter ..... 1
- Wired remote control cable ..... 1
- Warranty ..... 1
- Owner's manual (this document) ..... 1

Please open the packaging carefully to avoid damaging the unit, and keep the box and packaging for transportation in the future.

---

## Conventions used in this manual

---

The following conventions are used in this manual.

- “SD memory card” is sometimes abbreviated as “SD card.”
- Keys and connectors on this device are indicated like this: **KEY**
- Messages on the unit's screen are shown like this: `Message`
- Additional information is provided as necessary as “tips,” “notes” and “cautions.”

### TIP

*These are tips about how to use the unit.*

### NOTE

*These provide additional explanations and describe special cases.*

### CAUTION

*Failure to follow these instructions could result in injury, damage to equipment or lost recording data, for example.*

# 1-Introduction

## Recycling the lithium ion battery

This unit uses a lithium ion battery. When you no longer need the battery please help preserve the valuable resources it contains by returning it to a business that recycles rechargeable batteries.

■ Please contact a TASCAM sales representative if you have any questions.



## Trademarks, copyrights, and disclaimers

- TASCAM is a registered trademark of TEAC Corporation.
- SDHC logo is a trademark. 
- Microsoft and Windows are either registered trademarks or trademarks of Microsoft Corporation in the United States and/or other countries.
- Macintosh, Mac OS and Mac OS X are trademarks of Apple Inc.
- Supply of this product does not convey a license nor imply any right to distribute MPEG Layer-3 compliant content created with this product in revenue-generating broadcast systems (terrestrial, satellite, cable and/or other distribution channels), streaming applications (via Internet, intranets and/or other networks), other content distribution systems (pay-audio or audio-on-demand applications and the like) or on physical media (compact discs, digital versatile discs, semiconductor chips, hard drives, memory cards and the like). An independent license for such use is required. For details, please visit <http://mp3licensing.com>.
- MPEG Layer-3 audio coding technology licensed from Fraunhofer IIS and Thomson.
- Other company names, product names and logos in this document are the trademarks or registered trademarks of their respective owners.

Any data, including, but not limited to information, described herein are intended only as illustrations of such data and/or information and not as the specifications for such data and/or information. TEAC Corporation disclaims any warranty that any use of such data and/or information shall be free from infringement of any third party's intellectual property rights or other proprietary rights, and further, assumes no liability of whatsoever nature in the event of any such infringement, or arising from or connected with or related to the use of such data and/or information.

This product is designed to help you record and reproduce sound works to which you own the copyright, or where you have obtained permission from the copyright holder or the rightful licensor. Unless you own the copyright, or have obtained the appropriate permission from the copyright holder or the rightful licensor, your unauthorized recording, reproduction or distribution thereof may result in severe criminal penalties under copyright laws and international copyright treaties. If you are uncertain about your rights, contact your legal advisor. Under no circumstances will TEAC Corporation be responsible for the consequences of any illegal copying performed using the recorder.



---

## SD cards

---

This unit uses SD cards for recording and playback. A list of SD cards that we have confirmed to work with this unit is provided on our website (<http://www.tascam.com/>).

---

## Precautions for use

---

SD cards are delicate media. In order to avoid damaging a card or the card slot, please take the following precautions when handling them.

- Do not leave in extremely hot or cold places.
- Do not leave them in extremely humid places.
- Do not let them get wet.
- Do not put things on top of them or twist them.
- Do not hit them.

---

## Beware of condensation

---

If the unit is moved from a cold to a warm place, or used after a sudden temperature change, there is a danger of condensation; vapor in the air could condense on the internal mechanism, making correct operation impossible. To prevent this, or if this occurs, let the unit sit for one or two hours at the new room temperature before using.

---

## Cleaning the unit

---

To clean the unit, wipe gently with a soft dry cloth. Do not use any benzene, paint thinner, ethyl alcohol or other chemical agents to clean the unit as they could damage the surface or cause fading.

# 2-Quick Start Guide

Follow these steps to use the built-in mics (UNI MIC) to record and playback your recording.

## Turn the power on

### 1 Prepare the power supply.

To use battery power, install a charged lithium ion battery or AA batteries. (See "Using with batteries" on page 17.)

### Types of batteries that can be used

- Lithium ion battery (included)
- AA alkaline batteries (LR6)
- AA Ni-MH batteries (HR15/51)

#### NOTE

- Manganese dry cell batteries (R6) cannot be used with this unit.
- This unit cannot recharge Ni-MH batteries. Use a commercially available recharger.

Installation of the lithium ion battery

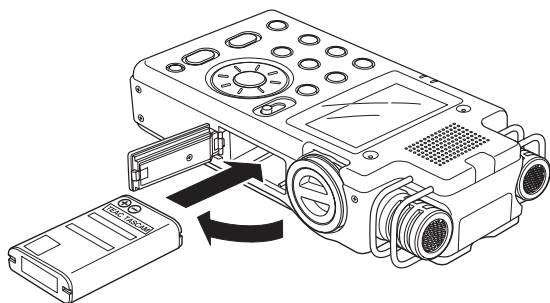

Installation of the AA batteries

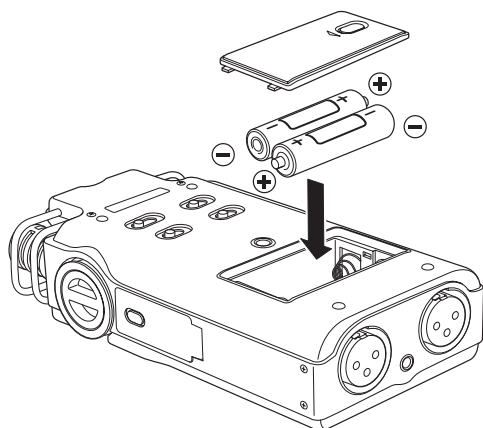

Never use any adapter other than the designated PS-P520 AC adapter. (See "Using an AC adapter (sold separately)" on page 18.) Use of a different adapter could cause malfunction, fire or electric shock.

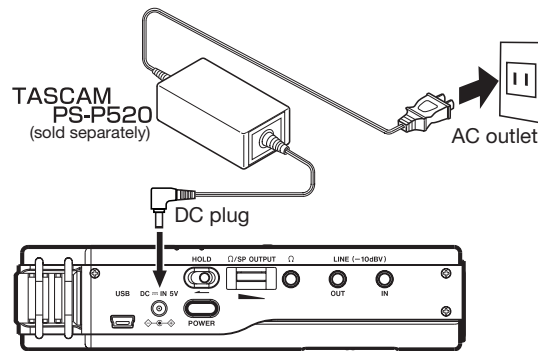

### 2 Insert an SD card.

Insert a new SD card or one that has been formatted for use with this unit. (See "Inserting and removing SD cards" on page 20.)

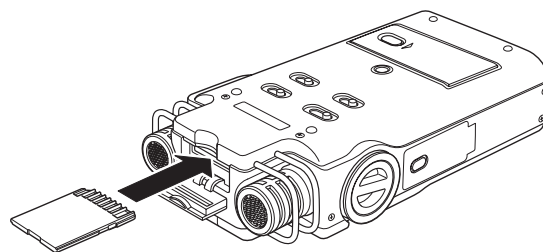

#### NOTE

- An SD card is already installed when the unit is shipped from the factory. If you want to use this card to record and play tracks, there is no need to reinstall it.
- The included SD card is already formatted.

### 3 Turn the power ON.

Press and hold the POWER key to turn the power ON.

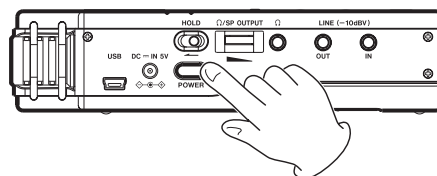

# 2-Quick Start Guide

## Prepare to record

### 1 Format the SD card (if necessary).

If a new card or one that has not been formatted by this unit is installed, the following message appears.

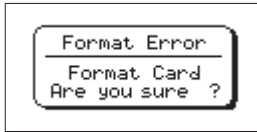

Press the ENTER/MARK key to start formatting the card.

#### NOTE

The included SD card is already formatted, so there is no need to reformat it.

### 2 Set the date and time.

This unit uses its internal clock to make a record of the date and time when a file is recorded.

You can record without making the setting, but the unit is set to the default value of "2000/01/01 00:00". (See "Setting the date and time" on page 21.)

### 3 Set the recording format

Set the recording mode and sampling frequency. (See "Preparing with the REC SETTING menu" on page 25.)

If you skip this step, the unit will record with the following default values.

Recording mode: WAV 16 bit

Sampling frequency: 44.1 kHz

## Start and stop recording

Follow these steps to use the built-in mics (UNI MIC) to record.

### 1 Set the input signal.

Move the INPUT switch to UNI.

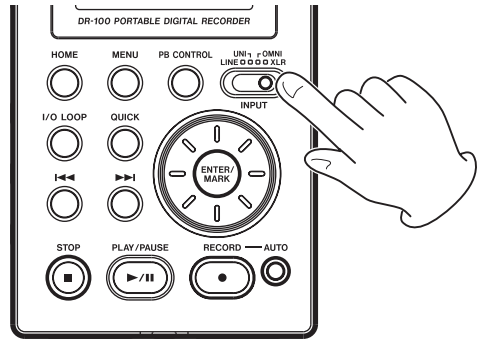

### 2 Adjust the recording level.

Press the RECORD [●] key to put the unit in recording standby.

Adjust the input level using the INPUT volume control and the MIC GAIN switch until the meters show as much level as possible without causing the PEAK indicator to light. (See "Adjusting the input level" on page 27.)

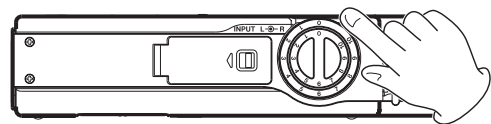
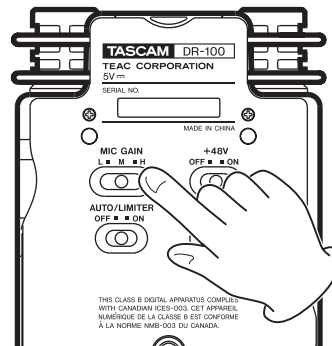

### 3 Record.

Press the RECORD [●] key to start recording from recording standby.

### 4 Stop recording.

Press the STOP [■] key to stop recording.

For detailed information about recording methods and convenient recording functions, see "6-Recording" on page 25.

# 2-Quick Start Guide

## Play and stop playback

Follow these steps to listen to a recording using the built-in speaker or headphones.

### 1 Prepare the built-in speaker or headphones.

If you want to listen using the built-in speaker, set the **SPEAKER** switch to **ON**.

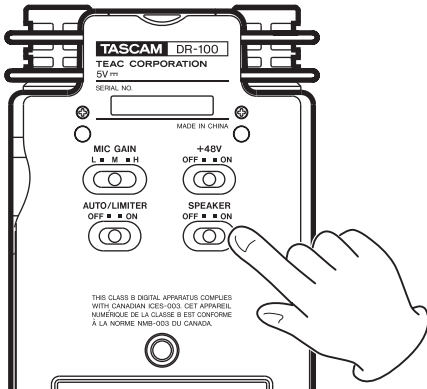

To listen with headphones, connect them to the headphones  $\Omega$  connector.

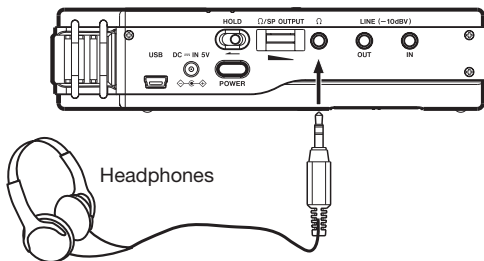

### NOTE

When headphones are connected, sound will not be output from the speaker even if the **SPEAKER** switch is **ON**.

### 2 Press the **PLAY/PAUSE** [▶/||] key to start playback.

### 3 Adjust the volume with the $\Omega$ /SP OUTPUT control.

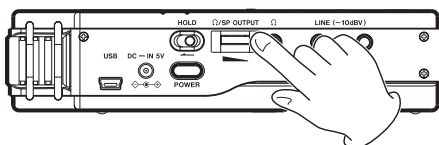

### 4 Press the **STOP** [■] key to stop playback.

For detailed information about playback and convenient playback functions, see “7-Playback” on page 33.

## Turn the power off

Press and hold the **POWER** to turn the power off.

### CAUTION

Always use the power key to turn the unit power **OFF**. When the power is **ON**, do not remove the battery or batteries set as the **MAIN** battery or disconnect the **PS-P520** adapter (sold separately) if no batteries are installed. Doing so will cause all recordings, settings and other data to be lost.

# 3-Names and Functions of Parts

## Top panel

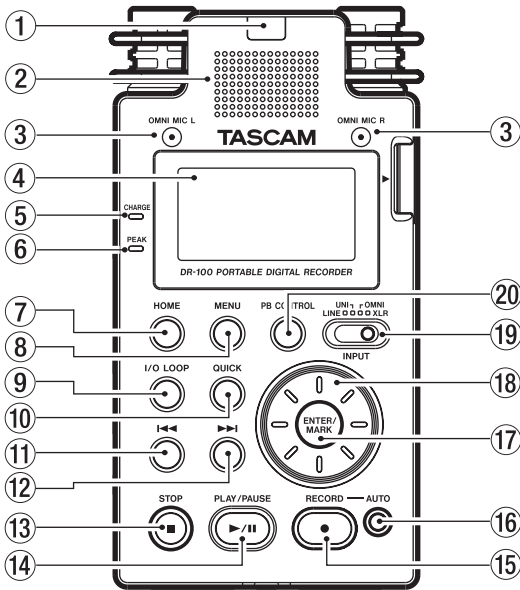

### ① Remote control receiver

Receives signals from the included remote control (RC-DR100). When using the remote point it here. (See “Using the remote control” on page 19.)

### ② Mono speaker

Use this built-in speaker to listen to recordings. Sound is not output during recording, when the unit is in recording standby or when headphones are connected. (See “Using the built-in speaker” on page 21.)

### ③ Omnidirectional stereo mic pair (OMNI MIC)

Two built-in mics allow recording in stereo. Select OMNI using the INPUT switch to set these as the input source. (See “Setting the input” on page 25.)

### ④ Display

Shows a variety of information. (See “5—Screens and Operation Basics” on page 22.)

### ⑤ CHARGE indicator

Lights when charging and turns off when charging is complete. (See “Charging the lithium ion battery” on page 17.)

### ⑥ PEAK indicator

Lights when the input volume is too high. (See “Adjusting the input level” on page 27.)

### ⑦ HOME key

Press this key when one of the setting screens is open to return to the Home Screen. When the Home Screen is open, press this to switch between displaying elapsed and remaining time. (See “Home Screen” on page 22.)

### ⑧ MENU key

Press to open the MENU Screen. (See “Using menus” on page 23.)

### ⑨ I/O LOOP key

Press to set starting (IN) and ending (OUT) points for loop playback. (See “Loop playback (I/O LOOP)” on page 36.)

### ⑩ QUICK key

Opens the QUICK TAG and DELETE menu. (See “Add identification tags to files (QUICK TAG)” and “Delete the selected playback file (QUICK DEL)” on page 39.)

### ⑪ ◀◀ key

Press this key briefly to return to the start of a file. If the playback position is already near the start of a track, it will skip to the start of the previous file. Press and hold this to search a track in reverse.

Use it also to move the cursor left on menu screens as well as to move up a level on the BROWSE screen. (See “Showing files inside folders” on page 38.)

### ⑫ ▶▶ key

Press this key briefly to move to the start of the next file.

Press and hold this to search a track forward.

Use it also to move the cursor right on menu screens and to move down one level on the BROWSE screen. (See “Working with folders” on page 38.)

### ⑬ STOP [■] key

Press to stop playback and recording. (See “Stop recording” on page 27.) Use it also to cancel certain operations (select MD).

### ⑭ PLAY/PAUSE [▶/||] key

Press to start and pause playback. (See “Playback (PLAY)” on page 33.)

### ⑮ RECORD [●] key

Press to start and pause recording. (See “Recording” on page 27.)

### ⑯ AUTO key

Use this to make various settings for the automatic recording function and to enable it. (See “Automatic recording (AUTO REC)” on page 29.)

### ⑰ ENTER/MARK key

Use this to confirm selections. When recording, use it to add markers manually. (See “Adding marks manually to a recording” on page 30.)

### ⑱ Wheel

Use this to select items and change values on setting screens. (See “10—Settings and Information” on page 40.)

Use it also to change the playback position in

## 3–Names and Functions of Parts

a track. (See “Using the wheel to change the playback position” on page 33.)

### 19 INPUT selection switch

Set to the desired input signal source. (See “Setting the input” on page 25.)

### 20 PB CONTROL key

Use to open and close the playback control screen and to turn its functions ON and OFF. (See “Adjusting the playback speed (PB CONTROL)” on page 36.)

## Right side panel

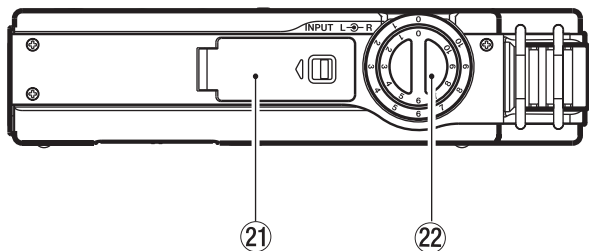

### 21 Battery compartment (specialized lithium ion battery)

Compartment for the unit’s dedicated lithium ion battery. (See “Using the lithium ion battery” on page 17.)

### 22 INPUT LEVEL knob

Adjusts the input volume. (See “Adjusting the input level” on page 27.)

## Left side panel

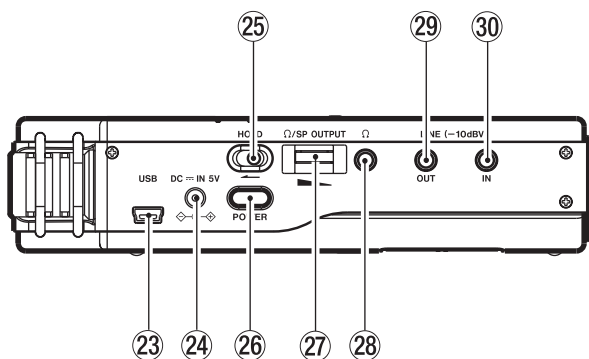

### 23 USB port

Connect to a computer using the included USB cable. (See “8–Connecting with a Computer” on page 37.)

### 24 DC IN 5V connector

Connect a PS-P520 AC adapter (sold separately). Do not connect any other type of AC adapter.

### 25 HOLD switch

Shift in the direction of the arrow to engage the hold function, which prevents unintentional operation.

### 26 POWER key

Press and hold to turn the power ON and OFF.

### 27 HEADPHONE/SP OUTPUT volume

Use to adjust the volume output from the headphones.

### 28 HEADPHONE Connector

Use to connect headphones. (See “Connecting monitors and headphones” on page 21.)

### 29 LINE OUT connector

Use a stereo minijack cable to connect to the line input connector on an external device. (See “Connecting monitors and headphones” on page 21.)

### 30 LINE IN connector

Use a stereo minijack cable to connect to the line output connector on audio equipment or other external device. (See “Recording an external device (LINE)” on page 26.)

## Front panel

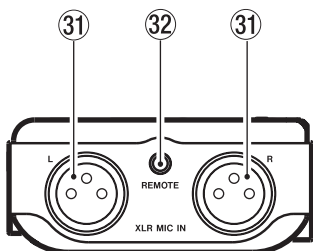

### 31 XLR MIC IN connectors

Connect external mics (See “Recording with external mics (XLR)” on page 26.)

### 32 REMOTE connector

Connect the included wired remote control. (See “Using the remote control” on page 19.)

# 3-Names and Functions of Parts

## Rear panel

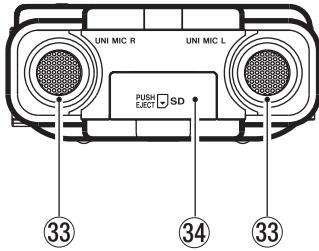

SD card slot cover closed.

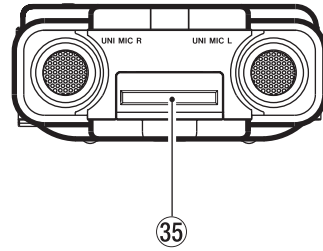

SD card slot cover open.

- 33 **Directional stereo mic pair (UNI MIC)**  
Set the INPUT switch to UNI MIC to make these electret condenser stereo mics the input source.
- 34 **SD card slot cover**

- 35 **SD card slot**  
Insert the SD card here. (See “Inserting and removing SD cards” on page 20.)

## Bottom panel

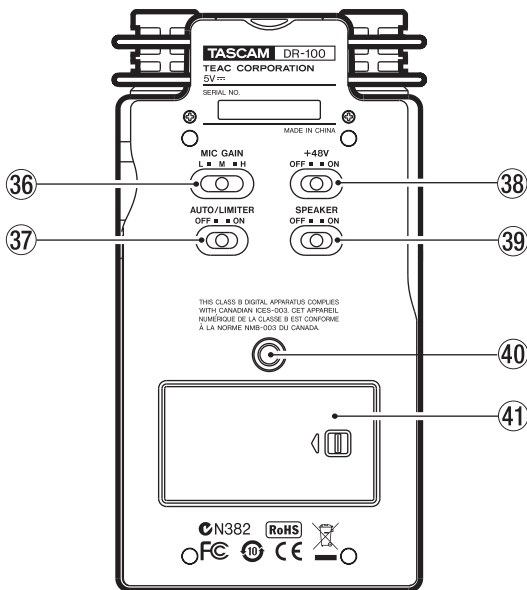

- 36 **MIC GAIN switch**  
Set the sensitivity of the mic input. (See “MIC GAIN” on page 27.)
- 37 **AUTO/LIMITER switch**  
Set this to ON to activate the limiter or automatic gain control. (See “Using the auto gain control and limiter (LEVEL CTRL)” on page 42.)
- 38 **+48V (phantom power) switch**  
Turn this ON to provide +48 V of power when a condenser mic is connected. (See “Recording with external mics (XLR)” on page 26.)

### CAUTION

Do not connect or disconnect mics when the +48V switch is ON.

### 39 SPEAKER switch

Set this to ON to output sound from the built-in speaker. (See “Using the built-in speaker” on page 21.)

### NOTE

Even when ON, no sound is output during recording, in recording standby or when headphones are connected.

### 40 Tripod attachment screw-hole (1/4-inch)

Use this to attach the unit to a tripod or mic stand.

### CAUTION

- Tighten the unit securely to the tripod or mic stand to prevent it from falling off.
- Place the tripod or mic stand on a level surface when using it with this unit.
- Some tripods use different types of screws, so it might not be possible to attach the unit directly. In such a case, purchase and use a suitable adapter.

### 41 Battery compartment cover

## 3-Names and Functions of Parts

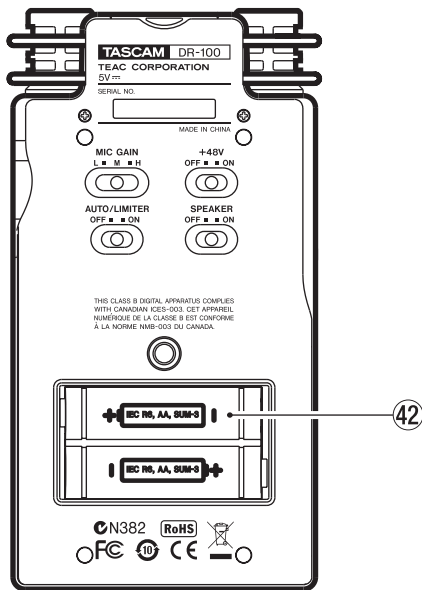

### 42 AA battery compartment

This compartment can hold two AA batteries that can power the unit. (See "Using AA batteries" on page 17.)

## Remote control (RC-DR100)

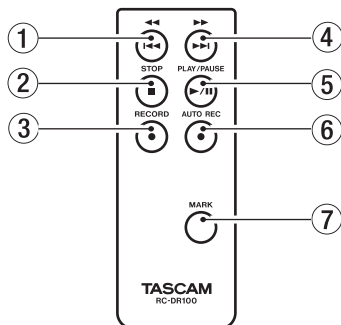

### 1 <</I<< key

Press this key briefly to return to the start of a file. If the playback position is already near the start of a track, it will skip to the start of the previous file. Press and hold this to search a track in reverse.

### 2 STOP [■] key

Press to stop playback and recording. (See "Stop recording" on page 27.)

### 3 RECORD [●] key

Press to start and pause recording. (See "Recording" on page 27.)

### 4 >>/>>I key

Press this key briefly to move to the start of the next file. Press and hold this to search a track forward.

### 5 PLAY/PAUSE [▶/||] key

Press to start and pause playback. (See "Playback (PLAY)" on page 33.)

### 6 AUTO REC key

Use this with the automatic recording function. Unlike the key on the main unit, this key alone can put the unit into recording standby. (See "Automatic recording (AUTO REC)" on page 29.)

### NOTE

Use the main unit to make various AUTO REC function settings.

### 7 MARK key

Use this to set playback position markers that can be skipped to. (See "Mark function" on page 30.)



# 4-Preparation for Use

## Using with batteries

This unit can be powered by both a lithium ion battery and two AA batteries.

By using both types of batteries together, the unit can be operated continuously for a long time.

Moreover, one type of battery can be changed while the unit continues to operate when, for example the charge becomes low in one of the batteries.

### Types of batteries that can be used

- Lithium ion battery (included)
- AA alkaline batteries (LR6)
- AA Ni-MH batteries (HR15/51)

#### NOTE

- Manganese dry cell batteries (R6) cannot be used with this unit.
- This unit cannot recharge Ni-MH batteries. Use a commercially available recharger.

## Using the lithium ion battery

Open the battery compartment cover on the side of the unit, and insert the battery into the compartment with the correct orientation.

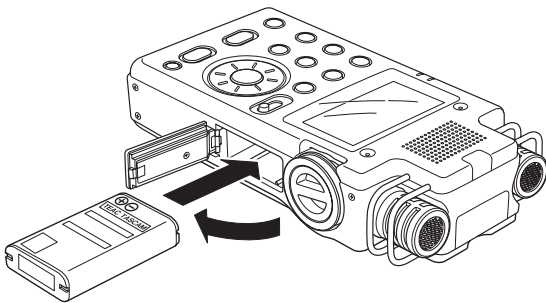

## Charging the lithium ion battery

There are two ways to charge the lithium ion battery.

### Charging with an AC adapter

Connect a PS-P520 AC adapter (sold separately) to the unit's DC IN 5V connector. Charging takes about three hours. (See "Using an AC adapter (sold separately)" on page 18.)

### Charging with a computer

Connect with a computer using the included USB cable. Charging takes about six hours. (See "8-Connecting with a Computer" on page 37.)

#### NOTE

- Connect this unit to the computer directly. Proper operation cannot be guaranteed when using a USB hub.
- When connected by USB, recharging occurs even if the unit's power is off.
- When recharging with a computer, this unit enters the USB mode, so other functions cannot be used.
- The CHARGE indicator lights while charging and turns off when charging is complete.

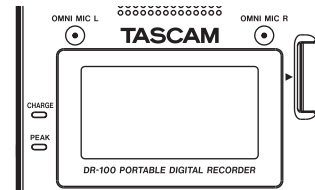

## Using AA batteries

Open the battery compartment cover on the back of the unit, install the batteries with the correct +/- orientation and close the battery compartment cover.

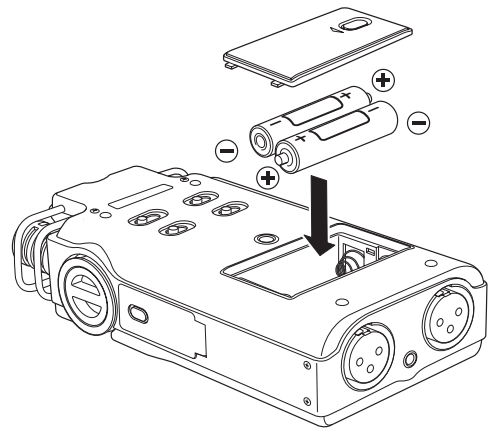

When using AA batteries, set the type of battery in order to accurately show the amount of power remaining and allow the unit to accurately determine whether power is available for proper operation. (See "Setting the type of AA batteries (AA BATTERY)" on page 45.)

# 4-Preparation for Use

## Using both types of batteries together

If you install both the lithium ion battery and AA batteries, you can set one as the main power source and the other as the backup. (See “Setting the main battery source (MAIN)” on page 44.) By doing this, when the amount of power left in the main source becomes insufficient for operation, the unit automatically switches to the backup source, allowing continued operation. Moreover, you can change the backup while operating using the main power source. This allows you to continue to use the unit for long periods of time. (See “Changing batteries when the power is on” on page 45.)

## Using an AC adapter (sold separately)

Connect to the PS-P520 AC adapter (sold separately) to the DC IN 5V connector as shown in the illustration.

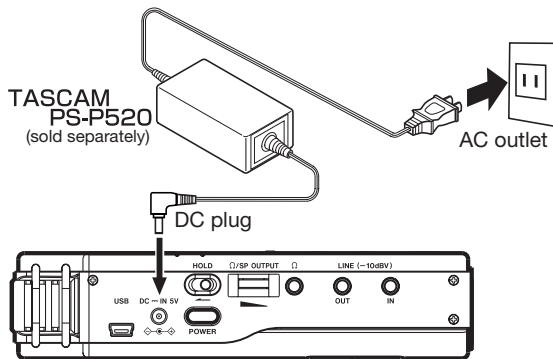

### NOTE

The AC adapter provides power when connected even if batteries are installed. If installed, the lithium ion battery can also be recharged while the unit is used.

### CAUTION

Never use any adapter other than the designated PS-P520 AC adapter. Use of a different adapter could cause malfunction, fire or electric shock.

## Preparing the remote control

### Installing the battery

#### 1 Remove the battery holder.

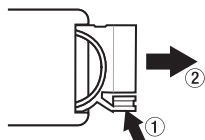

#### 2 Install the coin-shaped lithium ion battery (CR2025) into the holder with the correct +/- orientation.

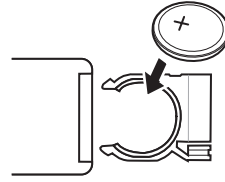

#### 3 Reinsert the battery holder into the remote control.

## When to change the battery

Replace the battery with a new one when the range of the remote control becomes short or if the function keys become unresponsive.

Use a coin-shaped lithium ion battery (CR2025).

## Cautions about the use of the battery

Accidental swallowing of batteries by small children is extremely dangerous. Keep batteries and remote controls out of reach of small children. Consult a physician immediately if a child should swallow a battery.

Misuse of a battery could cause it to leak, rupture or otherwise be damaged. Please read and abide by the following precautions when using batteries. (Also see “Cautions about rechargeable batteries” on page 4.)

- Install the battery with the correct orientation.
- Do not recharge the battery.
- Do not heat or disassemble the battery or put it into fire or water.
- Do not carry or store the battery with small metal objects. Doing so could short the battery and cause leakage or rupture, for example.
- When storing or disposing of the battery, cover the contacts with tape to prevent them from touching other batteries or metal objects.
- Follow the disposal instructions written on the battery or provided by the local government when you are done using it.

# 4-Preparation for Use

## Using the remote control

### Wireless use

Point the remote control at the remote control receiver on the unit.

#### CAUTION

If anything is between the remote control and the receiver, operation might not work.

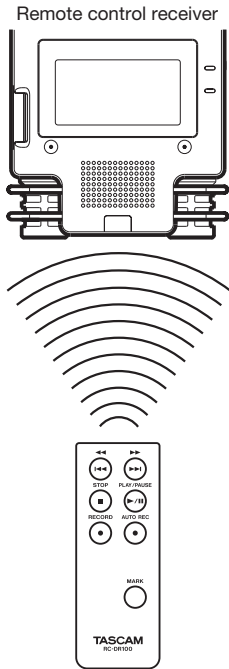

### Operation distance

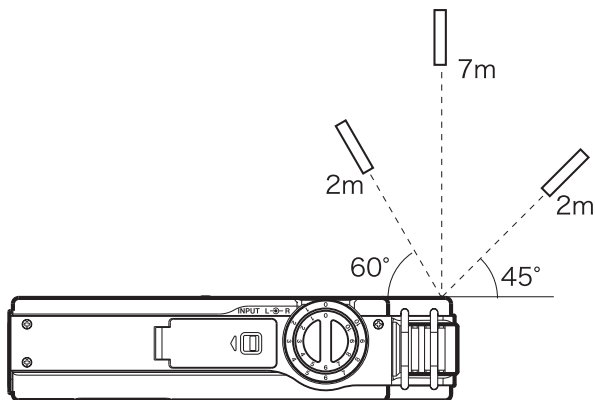

### Wired use

Attach the remote control adapter and cable

- 1 Insert the wireless remote control into the remote control adapter.

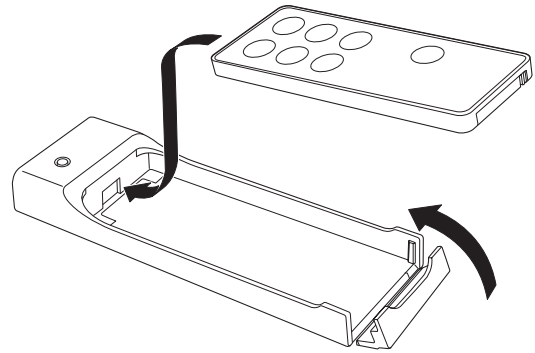

- 2 Connect the cable to the remote control adapter.

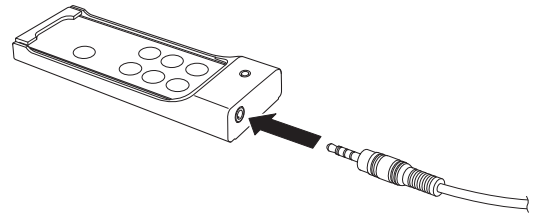

- 3 Connect the cable to the main unit.

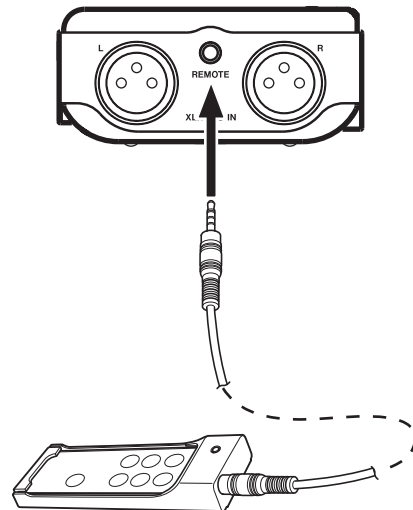

### Precautions for use of the remote control

Remove the battery when you are not using the remote control for a long time (one month or more).

If the battery should leak, thoroughly clean any residue from inside the battery compartment and install a new battery.

When using other devices controlled by infrared rays, use of this remote control might operate these devices by mistake.

## 4-Preparation for Use

### Turning the power on and off

Press and hold the **POWER** key to turn the power ON and OFF

#### CAUTION

Always use the power key to turn the unit power OFF. When the power is ON, do not remove the battery (or batteries) set as the MAIN battery or disconnect the PS-P520 adapter (sold separately) if no batteries are installed. Doing so will cause all recordings, settings and other data to be lost.

### Battery settings

You can set either the lithium ion battery or the AA batteries as the main power source and the other as the backup source when both are installed. (See “Setting the main battery source (MAIN)” on page 44.)

By doing this, when the amount of power left in the main source becomes insufficient for operation, the unit automatically switches to the backup source, allowing continued operation.

Moreover, when using AA batteries, the battery type must be set in order for the unit to display remaining time and operate correctly. (See “Setting the type of AA batteries (AA BATTERY)” on page 45.)

### Inserting and removing SD cards

Confirm that the power is OFF.

#### Inserting the card

Insert the SD card as shown in the illustration until you hear a clicking sound.

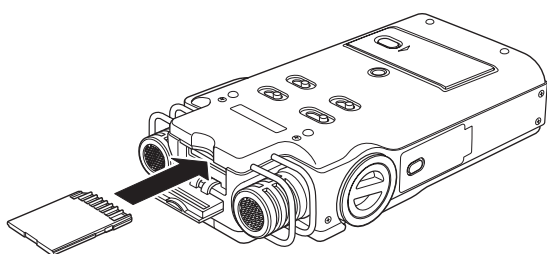

#### NOTE

An SD card is already installed when the unit is shipped from the factory. If you want to use this card to record and play tracks, there is no need to reinstall it.

### Removing the card

Push the SD card in gently and it should eject.

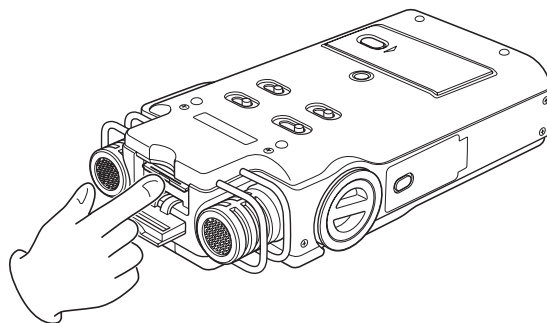

#### CAUTION

- Do not remove the SD card from the unit when it is connected to a computer by USB.
- SD cards that meet SD or SDHC standards can be used with this unit.
- A list of SD cards that have been confirmed to work with this unit can be found on our website (<http://www.tascam.com>).

### Preparing an SD card for use

In order to use an SD card in this unit, you must format it first.

- 1 **Confirm that an SD card is installed and turn the power ON.**
- 2 **The following message appears when a new card or a card formatted for use with another device is installed in the unit.**

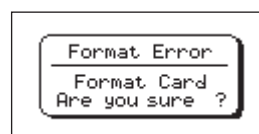

- 3 **Press the ENTER/MARK key to start formatting.**
- 4 **When formatting ends, the Home Screen opens.**

**You can also reformat the card in this unit at any time. (See “Formatting the SD card” on page 44.)**

#### CAUTION

- Please use a PS-P520 AC adapter (sold separately) or make certain that there is sufficient remaining battery power when formatting a card.
- Formatting a card erases all the data on it.

# 4-Preparation for Use

## Card write protection

SD cards have protect switches that prevent writing new data to them.

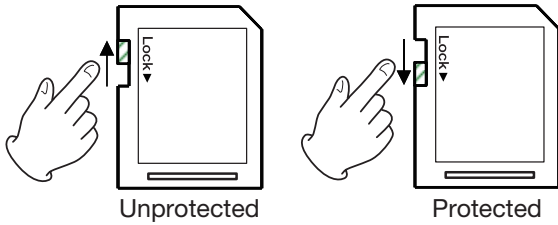

If you slide the protect switch to the "LOCK" position, file recording and editing is not possible. Move the switch to the unlocked position in order to record, erase and otherwise edit data on the card.

## Setting the date and time

Using its internal clock, this unit remembers the date and time when a file is recorded.

- 1 Press the MENU key to open the MENU screen.
- 2 Use the wheel to select DATE/TIME, and press the ENTER/MARK key.



- 3 Use the <<</>>> keys to move the cursor, and use the wheel to change values.
- 4 Press the ENTER/MARK key to confirm the change and return to the MENU screen.

### NOTE

You can set the unit to automatically add the date and time to file names. (See "Setting the file name format" on page 42.)

### CAUTION

The date and time setting can only be maintained for a few minutes when the unit is not powered by batteries or an AC adapter. When using batteries, we recommend that you replace or recharge them before they completely lose power.

## Using the built-in speaker

Set the SPEAKER switch to ON to listen to a playing track through the built-in speaker.

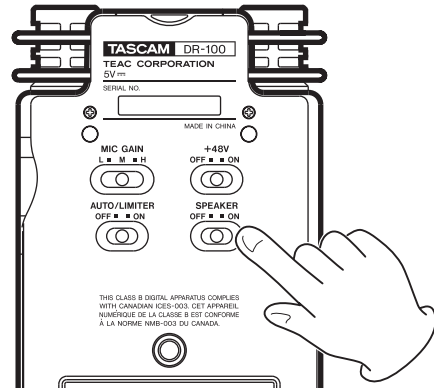

### NOTE

Even when ON, no sound is output during recording, in recording standby or when headphones are connected.

## Connecting monitors and headphones

To listen with headphones, connect them to the  connector.

To listen with an external monitoring system (powered speakers or an audio system), connect it to the LINE OUT connector.

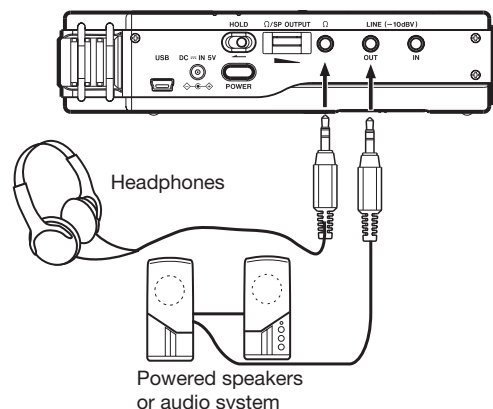

# 5—Screens and Operation Basics

## Home Screen

This screen appears when the unit's power is turned on. Press the HOME key at any time to open this screen.

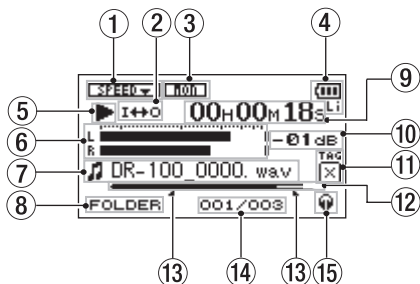

### ① Playback speed setting status

OFF	ON	Playback speed
SPEED -		0%
SPEED +		+1 — +16%
SPEED ▾		-50 — -1%

### ② Loop/repeat playback status

- SINGLE Single playback
- Single track repeat playback
- ALL All track repeat playback
- I↔O Loop playback

### ③ Input monitoring status

(See “Using input monitoring (MONITOR)” on page 41.)

- OFF
- ON

### ④ Power supply status

- Lithium ion battery
- AA batteries
- AC Adapter

When batteries are used, the amount of power remaining is shown as: .

When battery power is depleted the empty battery icon blinks. The power soon turns OFF automatically.

### NOTE

Sometimes a “Battery Low” warning appears when recording or conducting other demanding operations even when battery power remains.

### ⑤ Recorder operation status

- Stopped
- Paused
- Playing back
- Fast-forwarding
- Fast-rewinding

- Skipping forward
- Skipping backward

### ⑥ Level meters

When input monitor is OFF, the level of the playback sound is shown.

When inputs monitor is ON, the level of the combined input and playback sounds is shown.

### ⑦ File information

The file name or tag information of the file currently being played back is shown.

ID3 tag information is shown when available for an MP3 file being played.

### NOTE

ID3 tag information includes the titles and artists names that can be saved in MP3 files.

### ⑧ Playback range

- ALL All files in the MUSIC folder
  - FOLDER All files in the selected folder
  - P.LIST All files added to the playlist
- (See “Setting the playback area (AREA)” on page 34.)

### ⑨ Elapsed time/remaining time (hours: minutes: seconds)

Press the HOME key to toggle the display between elapsed and remaining time. A “-” appears at the start of the remaining time.

### ⑩ Peak value in decibels (dB)

The maximum level that occurs in a fixed period of time is displayed digitally.

### ⑪ Identification tag

If an identification tag has been added using the QUICK TAG function, it will appear here.

### ⑫ Playback position display

The current playback position is shown by a bar. As playback progresses, the bar extends to the right.

### ⑬ Loop playback IN (starting) and OUT (ending) points

The set starting and ending points of the loop are shown.

The icon appears at the playback position when the starting point is set.

The icon appears at the playback position when the ending point is set.

### ⑭ Playback file number/total number of files

The total number of files in the playback area and the number of the current file are shown.

### ⑮ Monitoring output

- Headphones
- Speakers

# 5-Screens and Operation Basics

## Recording screen

This screen appears when in recording standby and during recording.

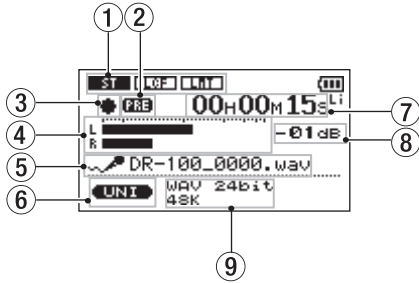

### ① Input function setting status

#### TYPE

- Stereo
- ST Mono

(See “Setting mono input (TYPE)” on page 41.)

#### LOW CUT

- LCF OFF
- ON

(See “Using the low cut filter (LOW CUT)” on page 41.)

#### LEVEL CTRL

- AUTO /  Auto gain control
- LMT /  Limiter

(See “Using the auto gain control and limiter (LEVEL CTRL)” on page 42.)

### ② Prerecording function status

“PRE” appears when the prerecording function is ON.

### ③ Recorder operation

- Standby
- Paused
- Recording

### ④ Recording level meters

When overdubbing is off, the input signal level is shown.

When over dubbing is on, the combined input and playback signals are shown.

### ⑤ File name

The file name that will automatically be given to recorded files is shown.

### ⑥ Input signal

The input signal is shown.

### ⑦ Elapsed time/remaining time (hours: minutes: seconds)

Shows the amount of time that can be recorded when in standby.

Press the HOME key to toggle between display of elapsed and remaining time. A “-” appears at the start of the remaining time.

### ⑧ Peak value in decibels (dB)

Peak recording level values are shown digitally.

### ⑨ Recording mode/sampling frequency

Shows the recording file format and sampling frequency.

## Using menus

Use the MENU screen to make various settings.

### 1 Press the MENU key to open the MENU screen.



2 Use the wheel to select a menu (selected items are highlighted and appear as light letters on a dark background), and press the ENTER/MARK key to open a setting screen.

Example: REC SETTING screen

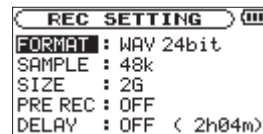

3 Use the wheel to select (highlight) a setting item, and press the ►► key (or the ENTER/MARK key) to select the value of the setting.

Example: setting the sampling frequency

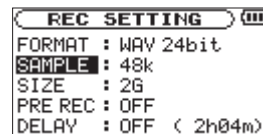

4 Use the wheel to change the setting.

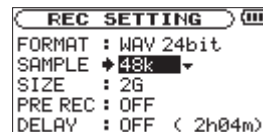

5 Complete the change.

To set a different item in the same menu, press the ◀◀ key to select the item you want to set.

To open the MENU screen, press the MENU key.

To return to the Home Screen, press the HOME key.

# 5–Screens and Operation Basics

## Basic operation

Use the following keys to operate the various screens.

### Open screens

MENU, PB CONTROL, AUTO and HOME keys

### Confirm operations

ENTER/MARK key

### Cancel operations

STOP key

### Move left and right

◀◀/▶▶ keys

### Change settings

Wheel

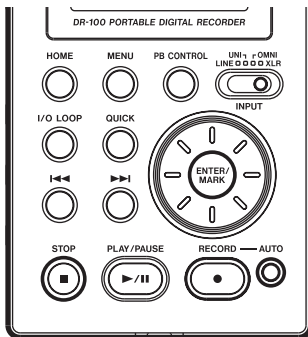

### MENU key

Opens the MENU screen.

### PB CONTROL key

Opens the PB CONTROL screen.

### AUTO key

Opens the AUTO REC screen.

### HOME key

When any other screen is open, press this to return to the Home Screen.

### ENTER/MARK key

Use this to confirm the selection of a setting item or to answer “YES” to a confirmation message.

### STOP key

Use this to answer “NO” to a confirmation message.

### ▶▶ key

Use this to move the cursor (the highlighted area) to the right on the screen, and to open folders on the BROWSE screen.

### ◀◀ key

Use this to move the cursor (the highlighted area) to the left on the screen, and to close folders on the BROWSE screen.

### Wheel

Use this to select items and to change values.



## Preparing with the REC SETTING menu

Make settings suitable to the recording material and conditions.

- 1 Press the MENU key to open the MENU screen.
- 2 Use the wheel to select REC SETTING, and press the ENTER/MARK key.

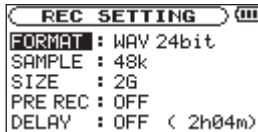

- 3 Use the FORMAT item to set the recording mode, choosing from the following options.

WAV 16/24 bit

MP3 32/64/96/128/192/256/320 kbps

- 4 Use the SAMPLE item to set the sampling frequency, choosing either 44.1 or 48 kHz.

- 5 Use the SIZE item to set the maximum size, choosing from the following options.

64M/128M/256M/512M/1G/2G

### NOTE

- Higher values provide better recording quality. WAV files are higher quality than MP3 files, but they take up more space, so MP3 formats allow for longer recordings.
- If the maximum set file size is exceeded during recording, the unit will automatically continue recording in a new file.
- Depending on the file format, the amount of recording time will differ for the same file size.
- Recording automatically stops if recording time exceeds 24 hours.

## Available recording time display

The amount of time available for recording depends on the capacity of the SD card as well as the recording mode and sampling frequency settings. (See “Recording time” on page 32.)

You can check the potential recording time determined by the SD card and various settings on the REC SETTING screen.

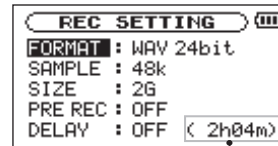

Time available for recording

## Setting the input

Select the recording input source by using the input switch on the top panel.

- LINE LINE IN connector
- UNI Built-in directional stereo mics
- OMNI Built-in omnidirectional stereo mics
- XLR XLR MIC IN connectors

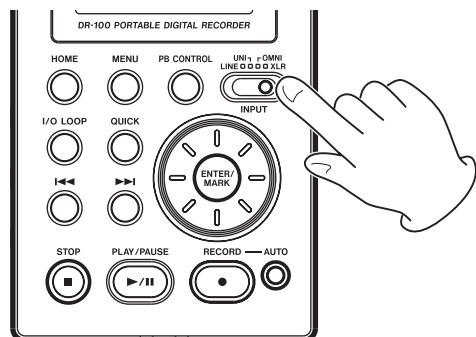

## Recording with the built-in mics (UNI/OMNI)

### UNI MICS

Set the INPUT switch to UNI.

These mics are suitable for recording live performances of instrumentalists and bands, as well as field recording, for example.

Point the mics at the sound source and place the unit in a stable location where there is little vibration.

If noise is caused by wind, attach the windscreen.

# 6-Recording

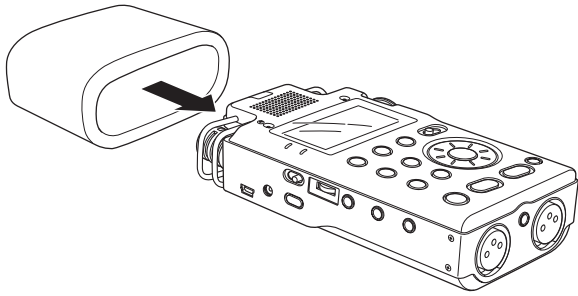

## OMNI MICS

Set the **INPUT** switch to **OMNI**.

These mics are suitable for recording meetings and other situations where you want to record everything in a wide space.

Place the unit in a stable location where there is little vibration.

### NOTE

If noise is caused by air-conditioning or a draft, for example, use the unit's low-cut filter. (See "Using the low cut filter (LOW CUT)" on page 41.)

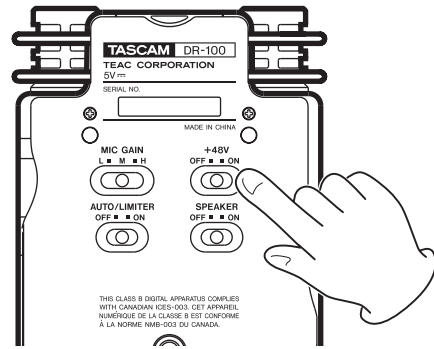

### CAUTION

- Do not connect or disconnect mics when the 48V switch is ON.
- Connecting a dynamic mic or other mic that does not require phantom power when the +48V switch is on could damage it. Please refer to the manual for the mic for details.
- Since using phantom power reduces the amount of time the unit can operate on battery power, we recommend using an AC adapter (sold separately).
- Since some mics drain alkaline batteries extremely quickly, we recommend using the included BP-L2 lithium ion battery when operating on battery power. The amount of time that the unit can operate on battery power varies greatly according to the type of mic used. See the mic manual or documentation for additional information.

## Recording with external mics (XLR)

Set the **INPUT** switch to **XLR**.

Connect an external XLR mic to the **XLR MIC IN** connector.

When only one mic is connected, it is possible to record the same signal on both left and right channels. (See "Setting mono input (TYPE)" on page 41.)

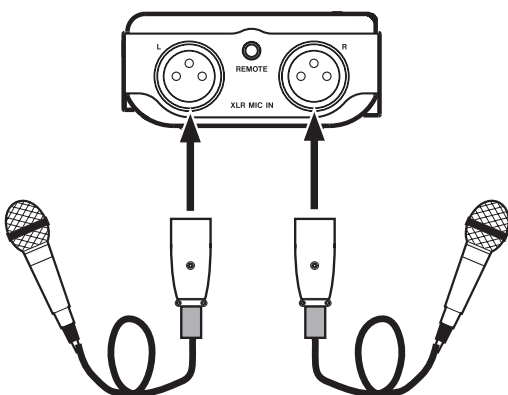

When using a condenser mic that requires phantom power, set the **+48V** switch to **ON**.

### NOTE

The XLR connector pins are as follows.  
1: Ground, 2: Hot, 3: Cold

## Recording an external device (LINE)

Set the **INPUT** switch to **LINE**.

Use a stereo miniplug cable to connect to the output of an external audio device.

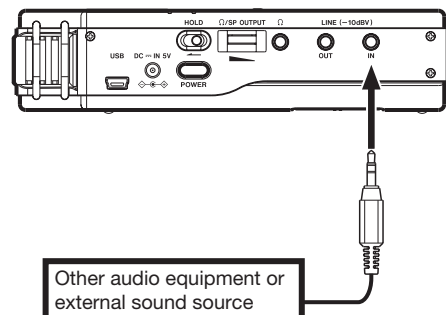

## Set where to save the file

Set the folder where recorded files are saved. If no setting is made, new recording files are placed in the **MUSIC** folder. (See "Working with folders" on page 38.)

## Adjusting the input level

- 1 Press the RECORD (●) key to put the unit in recording standby.

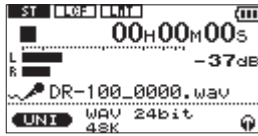

- 2 Set the MIC GAIN to M, and adjust the INPUT volume so that the level meters extend as far as possible without causing the PEAK indicator to light.

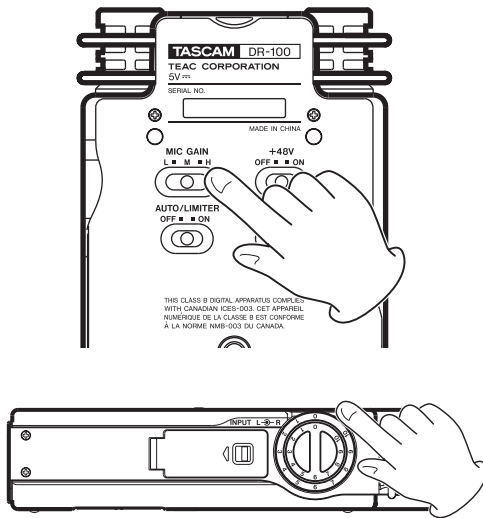

If the level meters do not extend very far even as the INPUT volume setting approaches 10, set the MIC GAIN to H. On the other hand, if the level meters stay extended even as the INPUT volume setting approaches 0, set the MIC GAIN to L.

### NOTE

If the INPUT switch is set to LINE, the MIC GAIN setting has no effect.

## MIC GAIN

### H (high)

Use with meetings, voices and other quiet or distant sounds

### M (mid)

Use with acoustic guitars and wind instruments, for example

### L (low)

Use with band performances and other loud or close sounds.

### NOTE

- When in recording standby or during recording, the speaker does not output sound even if the SPEAKER switch is ON.
- Connect headphones (sold separately) to the headphones connector (🎧) if you want to adjust the level or record while monitoring the input.
- Use the 🎧/SP OUT volume to adjust the monitoring volume. This does not affect the sound of the recording.
- In addition to adjusting the input volume, try adjusting the distance and angles between the mics and sound sources.
- Use the auto gain control and limiter functions to prevent loud sound sources from distorting when recording. (See "Using the auto gain control and limiter (LEVEL CTRL)" on page 42.)

## Recording

Press the RECORD (●) key to put the unit in recording standby.

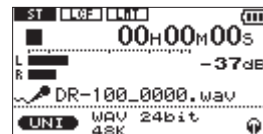

Press the RECORD (●) key again to start recording.

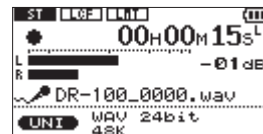

## Stop recording

When recording, press the STOP (■) key to stop recording and return to the beginning of the file.

## Pause recording

When recording, press the RECORD (●) key or the PLAY/PAUSE (▶/||) key to pause recording.

### NOTE

When paused, press the RECORD (●) key or PLAY/PAUSE (▶/||) key again to restart recording. This continues recording in the same file.

# 6-Recording

## Dividing files and creating new files while recording

### Creating new files manually while recording (track incrementing)

You can manually split a recording by creating a new file.

Press the ►► key while recording.

#### NOTE

When new files are created, incremental numbers are added to the end of each file name.

#### CAUTION

- A new file cannot be created if the total number of files and folders would exceed 999.
- Files shorter than two seconds cannot be created.
- If the name of a newly created file would be the same as that of an existing file, the number will be incremented until the new file has a unique name.

### Creating new files automatically while recording (automatic track incrementing)

Without pausing recording, a new file can be created automatically during recording when a file size or input level set in advance is exceeded. (See “Preparing with the REC SETTING menu” on page 25 and “Start new files automatically during recording (TRK INC)” on page 30.)

### Automatically cutting silences during recording

The unit can be set to automatically pause recording when it detects silence, and then restart recording when the signal is input again.

This does not create new files, but cuts unnecessary silences, reducing the amount of card space used. Moreover, a mark is automatically added at the time when the unit pauses, making division after recording easy. (See “Automatically adding marks when recording (MARK)” on page 29.)

### Dividing a file manually (DIVIDE)

You can split a recorded file into two files at any position you like. This is convenient for splitting a continuous recording into multiple files.

- 1 Select the file you want to divide.
- 2 Press the MENU key to open the MENU screen.
- 3 Use the wheel to select DIVIDE and press the ENTER/MARK key.



- 4 Use the wheel to determine where the file will be divided, and press the ENTER/MARK key.

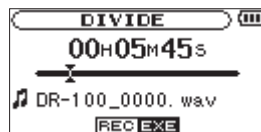

- 5 Press the ENTER/MARK key to divide the file, or press the STOP key to cancel the operation and return to the DIVIDE screen.

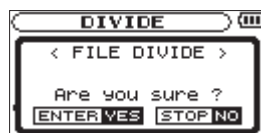

#### NOTE

- When the DIVIDE screen is open, you can press the PLAY/PAUSE (►/||) key and to set the divide position while playing the track.
- After dividing a file, two new files with “\_a” and “\_b” added to the end of the original file name are created. For example if the original filename is “DR-100\_0000.wav” then the new files will be named “DR-100\_0000\_a.wav” (the recording before the division point) and “DR-100\_0000\_b.wav” (the recording after the division point).
- MP3 files cannot be divided.
- If the SD card has insufficient open space, division might not be possible.
- Division is not possible if the file name would become more than 200 characters long.
- Division is not possible if a file that already exists has the same name as the name that would be given to a new file created by division.
- Add marks during recording at positions where you want to divide a file.
- Marks can be added manually (see “Adding marks manually to a recording” on page 30) or automatically when the unit detects silence (see “Automatically adding marks when recording (MARK)” on page 29). These marks can be easily located after recording.

## Automatic recording (AUTO REC)

This function allows the unit to respond to input sound levels and start and pause recording, as well as set marks and create new files, for example.

This function is convenient for recording only when people are speaking during meetings, creating marks for finding the starts of songs and dividing files after recording, and automatically dividing files.

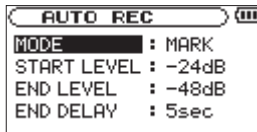

### MODE

MARK

Automatically adds marks during recording

PAUSE

Automatically pauses during recording

TRK INC

Automatically creates new files during recording

### START LEVEL

Signal is judged to have been input when it exceeds this level

### END LEVEL

Signal is judged to have stopped when it becomes less than this level

### END DELAY

Time that recording continues after the signal level becomes less than the END LEVEL

### NOTE

- If you press the AUTO key when recording or in recording standby, the current AUTO REC setting can be checked.
- When AUTO REC is on, the RECORD [●] key will blink more rapidly than usual in recording standby.
- Overdub recording is not possible when using the AUTO REC function.

## Enabling automatic recording

When the input signal exceeds the START LEVEL recording begins automatically.

### NOTE

The MODE setting does not affect this function.

- 1 Press the AUTO key to open the AUTO REC screen.
- 2 Set the value of the START LEVEL item.
- 3 Press the HOME key to return to the Home Screen.
- 4 Press the RECORD (●) key while holding down the AUTO key to put the unit into recording standby.

Recording starts automatically when the input signal exceeds the START LEVEL.

### NOTE

Press the STOP (■) key to stop automatic recording.

## Automatically adding marks when recording (MARK)

The unit can be set to automatically add marks to files during recording after they become less than the END LEVEL setting and the END DELAY time passes. Marks can also be automatically added when the input signal exceeds the START LEVEL setting again.

- 1 Press the AUTO key to open the AUTO REC screen.
- 2 Set the MODE item to MARK.

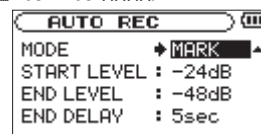

- 3 Set the value of the END LEVEL item.
- 4 Set the value of the START LEVEL item.
- 5 Press the HOME key to return to the Home Screen.
- 6 Press the RECORD (●) key while holding down the AUTO key to put the unit into recording standby.

Recording starts automatically when the input signal exceeds the START LEVEL value.

### NOTE

- Press the STOP (■) key to stop automatic recording.
- You can also add marks manually. (See "Adding marks manually to a recording" on page 30.)

# 6-Recording

## Automatically pausing recording (PAUSE)

You can set the unit to automatically pause after the input level of the recording becomes less than the END LEVEL setting and the END DELAY time passes.

- 1 Press the AUTO key to open the AUTO REC screen.
- 2 Set the MODE item to PAUSE.

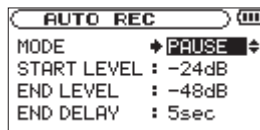

- 3 Set the value of the END LEVEL item.
- 4 Set the value of the END DELAY item.
- 5 Press the HOME key to return to the Home Screen.
- 6 Press the RECORD (●) key while holding down the AUTO key to put the unit into recording standby.

Recording starts automatically when the input signal exceeds the START LEVEL value.

### NOTE

Press the STOP (■) key to stop automatic recording.

## Start new files automatically during recording (TRK INC)

A new file can be created automatically during recording when, after once becoming less than the end level, the input signal exceeds the start level again.

- 1 Press the AUTO key to open the AUTO REC screen.
- 2 Set the MODE item to TRK INC.

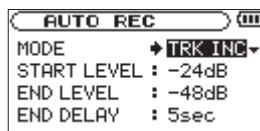

- 3 Set the value of the END LEVEL item.
- 4 Set the value of the START LEVEL item.
- 5 Press the HOME key to return to the Home Screen.
- 6 Press the RECORD (●) key while holding down the AUTO key to put the unit into recording standby.

Recording starts automatically when the input signal exceeds the START LEVEL value.

### NOTE

- Press the STOP (■) key to stop automatic recording.
- You can also create new files manually. (See "Dividing a recorded file manually (DIVIDE)" on page 28.)
- When new files are created, incremental numbers are added to the end of each file name.

### CAUTION

- A new file cannot be created if the total number of files and folders would exceed 999.
- Files shorter than two seconds cannot be created.
- If the name of a new created file would be the same as that of an existing file, the number will be incremented until the new file has a unique name.

## Mark function

### Adding marks manually to a recording

You can manually add marks to a recording where you want them.

Press the ENTER/MARK key while recording to add a mark.

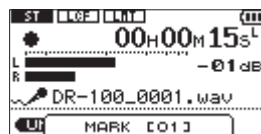

### NOTE

- A mark is automatically added when you restart recording after temporarily pausing.
- Mark information is stored in the file with numbers between 01-99. The maximum number of marks in a file is 99.

### Moving to a mark position

You can move to marks in the currently selected file when paused and during playback.

You can use this function to identify points to create shortcuts to the beginning of songs, for example.

Press the ◀◀/▶▶ keys while pressing and holding the ENTER/MARK key during playback or when stopped.

### NOTE

You cannot move to a mark in a different file.

## Recording the moment before pushing RECORD (PRE REC)

By using prerecording, when the unit is in recording standby you can record up to two seconds of the signal input before the RECORD (●) button is pushed to start recording.

- 1 Press the MENU key to open the MENU screen.
- 2 Use the wheel to select REC SETTING, and press the ENTER/MARK key.
- 3 Set the PRE REC item to ON.

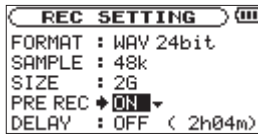

### TIP

By using this in combination with the auto-record function, you can record events without losing the beginnings of sounds.

### NOTE

- If the amount of time in record standby is less than two seconds, the sound for that amount of time is recorded.
- You cannot use the PRE REC function with overdub recording. When overdubbing please set the PRE REC item OFF.

## Delaying the start of recording (REC DELAY)

This function allows you to delay the start of recording by 0.3 seconds (fixed interval) after the RECORD (●) key is pressed.

This is useful when you want to avoid recording the sound of pressing the RECORD (●) key.

- 1 Press the MENU key to open the MENU screen.
- 2 Use the wheel to select REC SETTING, and press the ENTER/MARK key.
- 3 Set the DELAY item to ON.

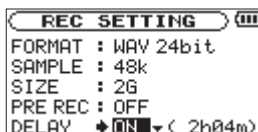

### NOTE

Set PRE REC to OFF when you set REC DELAY to ON.

## Recording playback and input sounds together (overdubbing)

When an audio file is playing back, you can record the playback sound together with the input sound. This creates a new file and does not overwrite the playback file.

## Adjust the levels of the input and playback sounds

Before recording the input and playback sounds together, you should carefully balance their levels.

- 1 Turn input monitoring ON.

This allows you to listen to the input sound even if the unit is not recording or in recording standby. (See “Using input monitoring (MONITOR)” on page 41.)

- 2 Select the audio file that you want to record, and press the PLAY/PAUSE (▶/||) key to start playback.
- 3 Adjust the playback and input signals so that the PEAK indicator does not light. (See “Adjusting the playback volume” on page 36.)

### NOTE

- You cannot change the input monitoring setting during recording or when in recording standby.
- When input monitoring is ON (and during overdub recording) the PEAK indicator shows the maximum level of the combined input and playback signals.

# 6-Recording

## Recording an overdub

- 1 Select the file that you want to overdub.
- 2 Press the RECORD (●) key to open a submenu.

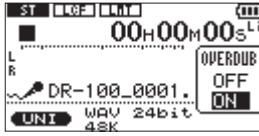

- 3 In the OVERDUB submenu, set it to ON.
- 4 Press the RECORD (●) key to start recording.

The following error message appears if the selected file cannot be played back.



### NOTE

- You cannot overdub if input monitoring is OFF or the PRE REC function is ON.
- When overdub recording, you cannot use the AUTO REC function or start new files manually.
- You cannot overdub when the recording format is MP3. Select WAV16BIT or WAV24BIT regardless of the format of the playback file. (See "Preparing with the REC SETTING menu" on page 25.) The sampling frequency of the playback file is preserved regardless of the sampling frequency setting for overdub recording.

## Stop overdubbing

Press the STOP (■) key during recording to stop recording and return to the start of the file.

### CAUTION

You cannot pause during overdub recording.

## Recording time

File format (recording setting)			SD/SDHC card capacity (hours:minutes)			
			1GB	2GB	4GB	8GB
WAV	16bit	44.1kHz	1:41	3:22	6:44	13:28
		48kHz	1:33	3:06	6:12	12:24
	24bit	44.1kHz	1:07	2:15	4:30	9:00
		48kHz	1:02	2:04	4:08	8:16
MP3	32kbps	44.1kHz/48kHz	74:32	149:04	298:08	596:16
	64kbps	44.1kHz/48kHz	37:16	72:32	149:04	298:08
	96kbps	44.1kHz/48kHz	24:50	49:40	99:20	198:40
	128kbps	44.1kHz/48kHz	18:38	37:16	74:32	149:04
	192kbps	44.1kHz/48kHz	12:25	24:50	49:40	99:20
	256kbps	44.1kHz/48kHz	9:19	18:37	37:16	74:32
	320kbps	44.1kHz/48kHz	7:27	14:54	29:48	59:36



## Selecting files for playback (skip)

When the Home Screen is open, press the ◀◀ and ▶▶ keys to select the file for playback.

If you press the ◀◀ key when the playback position is located at the middle of a file, it will return to the beginning of that file. If you press the ◀◀ key when located at the beginning of a file, the playback position will skip to the beginning of the previous file.

If you press the ▶▶ key when located at the beginning of or middle of a file, the playback position will skip to the beginning of the next file.

### NOTE

You can also choose files for playback by name. (See "Working with files" on page 39.)

## Playback (PLAY)

When the Home Screen is open and playback is stopped, press the PLAY/PAUSE (▶/||) key to start playback.

Use the Ω/SP OUTPUT volume to adjust the volume of the speaker or attached headphones.

### NOTE

Files in the playback area can be played. (See "Setting the playback area (AREA)" on page 34.)

## Stopping (STOP)

When the Home Screen is open and a track is playing back, press the STOP (■) key to stop playback at the current position.

Press the STOP (■) key again to return to the beginning of the file.

## Pausing (PAUSE)

When the Home Screen is open and a track is playing back, press the PLAY/PAUSE (▶/||) key to pause playback at the current position.

Press the PLAY/PAUSE (▶/||) key again to restart playback from that position.

## Rewinding and fast-forwarding (search)

When the Home Screen is open and a track is playing back or stopped, press and hold the ◀◀ or ▶▶ keys to rewind or fast-forward and search the playback track.

### NOTE

You can set the search speed. (See "Setting the search speed (CUE/REV SPEED)" on page 43.)

## Using the wheel to change the playback position

When the Home Screen is open and a track is playing back or stopped, you can use the wheel to change the playback position.

### NOTE

- The faster you turn the wheel, the more rapidly the position changes.
- No sound is output while the wheel is being turned.

## Repeat playback (REPEAT)

You can repeatedly playback one file or multiple files within a designated area.

- 1 Press the MENU key to open the MENU screen.
- 2 Use the wheel to select PLAY MODE and press the ENTER/MARK key.



- 3 Set the REPEAT item to one of the following selections

SINGLE

Play the selected file one time

1 REPEAT

Play the selected file repeatedly

ALL REPEAT

Play all the files in the designated area repeatedly

OFF

Play every file in the designated area once

- 4 Return to the Home Screen and select the file that you want to play. In the case of ALL REPEAT and OFF set the playback area first. (See "Setting the playback area (AREA)" below.)

# 7-Playback

## Setting the playback area (AREA)

Set the playback area for repeat and ordinary playback.

- 1 Press the MENU key to open the MENU screen.
- 2 Use the wheel to select PLAY MODE and press the ENTER/MARK key.

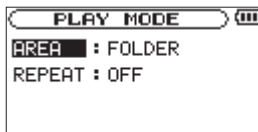

- 3 Set the AREA item to one of the following options.

ALL FILES

All files in the MUSIC folder are played back

FOLDER

All files in the designated folder are played back

### NOTE

- If you select FOLDER, choose the folder you want from the BROWSE screen. (See "Working with folders" on page 38.)
- If you select a file in a folder with the cursor and press the ►► key or the ENTER/MARK key and then choose PLAY from the submenu, the folder that contains the file becomes the selected folder.

PLAYLIST

Files in the playlist are played back in order

### NOTE

- If you select PLAYLIST, but no files have been added to the playlist, a "No PLAYLIST" pop-up appears.
- You can add files as you like to the playlist. (See "Adding files to the playlist" below.)

## Adding files to the playlist (PLAYLIST)

- 1 Press the MENU key to open the MENU screen.
- 2 Use the wheel to select BROWSE and press the ENTER/MARK key.
- 3 Select a file name that you want to add to the playlist, and press the ENTER/MARK key.
- 4 Select ADD LIST from the submenu and press the ENTER/MARK key to add that file to the playlist.



### NOTE

Tracks in the playlist are played back in the order that they were added.

## Working with the playlist

- 1 Press the MENU key to open the MENU screen.
- 2 Use the wheel to select PLAYLIST and press the ENTER/MARK key.



### NOTE

Select cancel in the submenu to close it.



## Changing the playlist order (MOVE)

- 1 Press the MENU key to open the MENU screen.
- 2 Use the wheel to select PLAYLIST, and press the ENTER/MARK key.
- 3 Use the wheel to select the file that you want to move, and press the ENTER/MARK key.



- 4 Select MOVE from the submenu, and press the ENTER/MARK key to highlight the file number.
- 5 Turn the wheel to set the desired position and press the ENTER/MARK key to move the file.
- 6 Repeat these procedures to reorder files as you like.

## Delete files from the playlist (DELETE)

- 1 Press the MENU key to open the MENU screen.
- 2 Use the wheel to select PLAYLIST, and press the ENTER/MARK key.
- 3 Use the wheel to select the file that you want to delete, and press the ENTER/MARK key.



- 4 Select DELETE from the submenu, and press the ENTER/MARK key to delete the file.
- 5 Repeat these procedures to delete other files.

### NOTE

Files deleted from the playlist are not erased from the unit.

## Clear the entire playlist (ALL CLR)

- 1 Press the MENU key to open the MENU screen.
- 2 Use the wheel to select PLAYLIST, and press the ENTER/MARK key.
- 3 Use the wheel to select any file name, and press the ENTER/MARK key.

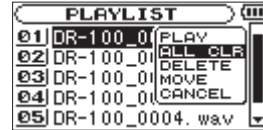

- 4 Select ALL CLR from the submenu, and press the ENTER/MARK key to open a confirmation screen.
- 5 Press the ENTER/MARK key to remove all files from the playlist, or press the STOP (■) key to cancel this operation.

### NOTE

Files deleted from the playlist are not erased from the unit.

## Play files in the playlist (PLAY)

- 1 Press the MENU key to open the MENU screen.
- 2 Use the wheel to select PLAYLIST, and press the ENTER/MARK key.
- 3 Use the wheel to select the file that you want to play, and press the ENTER/MARK key.



- 4 Select PLAY from the submenu, and press the ENTER/MARK key to return to the Home Screen and start playback.

# 7-Playback

## Loop playback (I/O LOOP)

You can set an IN point (starting point) and OUT point (ending point) within a file and play the part of the file between these points repeatedly.

- 1 When the Home Screen is open and the track is playing or paused, press the I/O LOOP key at the position where you want the loop to start to set the IN point.

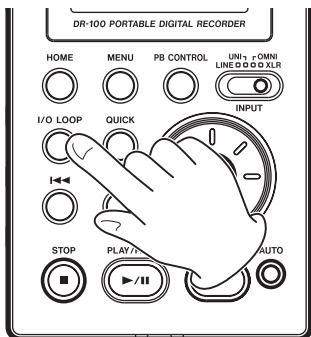

- 2 When the track is playing or paused, press the I/O LOOP key at the position where you want the loop to end to set the OUT point.
- 3 After setting both the IN and OUT points, loop playback starts automatically.
- 4 Press the STOP (■) key to stop loop playback.

You can also press the PLAY/PAUSE (▶/||) key to restart playback from the endpoint.

### NOTE

- You cannot set the IN and OUT points in different files.
- IN and OUT point settings are lost when you select a different file.
- If you press the I/O LOOP key when IN and OUT points are already set, their settings will be erased.
- Setting accurate IN and OUT points might not be possible with Variable Bit Rate (VBR) format MP3 files.

## Adjusting the playback speed (PB CONTROL)

You can adjust the playback speed by up to -50% or +16% of the original value. When doing so, it is possible to change the pitch with the speed or maintain the original pitch.

- 1 When the Home Screen is open, press and hold the PB CONTROL key to open the PB CONTROL screen.

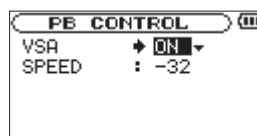
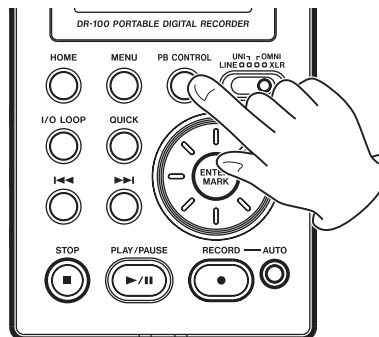

- 2 Set the VSA item to ON or OFF. When Variable Speed Audition (VSA) is ON, pitch does not change even when the speed is changed. When OFF, the pitch changes with the speed.
- 3 Use the SPEED item to adjust the playback speed.

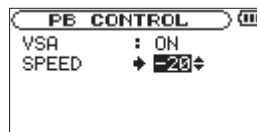

- 4 Press the HOME key to return to the Home Screen.
- 5 Press the PB CONTROL key briefly to turn this function ON and OFF.

### NOTE

You can also turn PB CONTROL ON and OFF from the PB CONTROL screen.

## Adjusting the playback volume

The volume output from the built-in speaker or the Ω connector can be adjusted by using the Ω/SP OUTPUT dial.

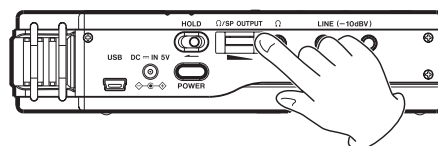

# 8-Connecting with a Computer

By connecting this unit with a computer using the USB cable, you can transfer audio files on the SD card in the unit to a computer, as well as transfer audio files on the computer to the SD card in the unit.

This unit can handle audio files of the following formats (only stereo files).

MP3: 32–320 kbps, 44.1/48 kHz

WAV: 44.1/48 kHz, 16/24 bit

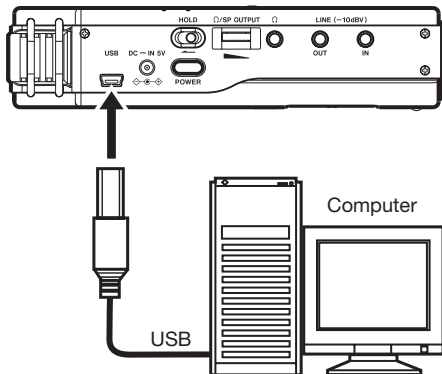

## CAUTION

You cannot use this unit's other functions when it is connected to a computer by USB.

When connected, "connected... USB" appears on the screen of the recorder.

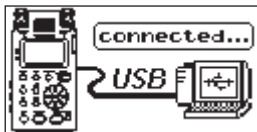

If an SD card is not properly inserted before making the USB connection, "Can't Save Data" appears on the screen.

This unit appears on the computer screen as external volume named "DR-100."

## Connecting a computer

Confirm that an SD card is properly inserted into the unit, and use the included USB cable to connect this unit with a computer.

## Transferring files to a computer

- 1 Click the "DR-100" drive on the computer screen to show the "MUSIC" and "UTILITY" folders.
- 2 Open the "MUSIC" folder and drag and drop the files that you want to transfer to the computer to destinations of your choice.

## Transferring files from a computer

- 1 Click the "DR-100" drive on the computer screen to show the "MUSIC" and "UTILITY" folders.
- 2 Drag and drop files on the computer that you want to transfer to the unit to the "MUSIC" folder.

## TIP

- You can manage the MUSIC folder from the computer.
- You can create subfolders in the MUSIC folder up to the second level for use with this unit. The DR-100 cannot recognize subfolders and audio files on the third level or below.

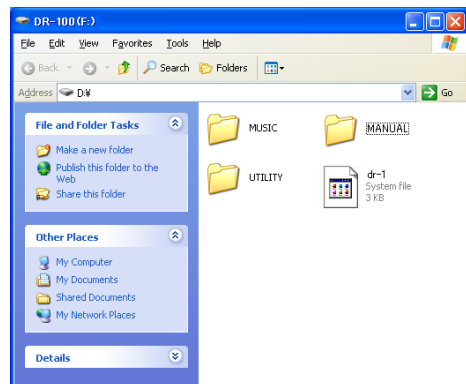

The MUSIC and UTILITY folders are in the "DR-100" drive.

## Disconnecting from a computer

Before disconnecting the USB cable, use the proper procedures for your computer to unmount the "DR-100" (as an external drive). The recorder will automatically restart.

See the computer's operation manual for instructions about how to unmount an external drive.

# 9–Working with Files and Folders

## Showing files inside folders

- 1 Press the MENU key to open the MENU screen.
- 2 Use the wheel to select BROWSE, and press the ENTER/MARK key.

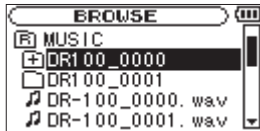

The Root Folder Holds all subfolders and files



A folder that contains a subfolder



A folders that does not contain a subfolder



Currently open folder



Audio file

- 3 Use the wheel to select a closed folder.

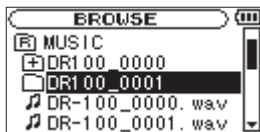

- 4 Press the >>> key to open the folder and view the files and folders inside it.

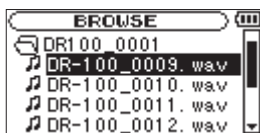

- 5 Press the <<< key to close the folder and move up a level.

## Working with folders

- 1 Press the MENU key to open the MENU screen.
- 2 Use the wheel to select BROWSE, and press the ENTER/MARK key.
- 3 Use the wheel to select a folder, and press the ENTER/MARK key to open a submenu.

Use the <<< and >>> keys to move up and down the folder levels, and press the ENTER/MARK key to open the submenu.

Use the wheel to select items on the same folder level.

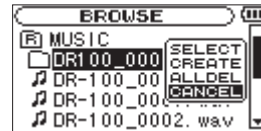

### NOTE

Choose CANCEL from the submenu to close it.

- 4 Choose one of the following options from the submenu, and press the ENTER/MARK key to execute it.

### SELECT

The first file in the selected folder is selected and the Home Screen reopens.

### CREATE

A new folder is created inside the selected folder.

### NOTE

If you want to create a folder under the root folder press the <<< key and select the folder. Press the ENTER/MARK key to open its submenu.

### CAUTION

Folders can only be made to two levels. If you try to create a new folder inside of a second level folder, "Layer too Deep" appears on the screen and a new folder is not created.

### ALLDEL

Delete all the files inside the selected folder.

### CAUTION

This operation does not delete subfolders inside the folder. Furthermore, this operation does not delete read only files and files that are not recognized by the unit.

# 9–Working with Files and Folders

## Working with files

- 1 Press the MENU key to open the MENU screen.
- 2 Use the wheel to select BROWSE, and press the ENTER/MARK key.
- 3 Use the wheel to select a file, and press the ENTER/MARK key to open its submenu.



### NOTE

Choose CANCEL from the submenu to close it.

- 4 Choose one of the following options from the submenu, and press the ENTER/MARK key to execute it.

PLAY

Return to the Home Screen and start playback of the selected file.

INFO

Display information about the selected file

ADD LIST

Add the selected file to the playlist

DELETE

Deleted the selected file

## Add identification tags to files (QUICK TAG)

You can easily add symbols to file names for identification.

This is useful for distinguishing important files from unimportant ones, for example.

- 1 When the Home Screen is open, press the QUICK key to open a popup menu.
- 2 Select TAG from the menu, and press the ENTER/MARK key.
- 3 Use the wheel to select a symbol (□ or ✕), and press the ENTER/MARK key to add it to the name, or press the STOP key to cancel adding a symbol.

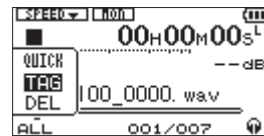

If you add a tag the filename changes as follows. For example, if the file name is "DR-100\_0000.wav" then the new filename becomes "DR-100\_0000\_o.wav" or "DR-100\_0000\_x.wav".

## Delete the selected playback file (QUICK DEL)

You can easily delete the selected playback file.

- 1 When the Home Screen is open, press the QUICK key to open a popup menu.
- 2 Select DEL from the menu, and press the ENTER/MARK key.
- 3 Press the ENTER/MARK key to delete the file, or press the STOP (■) key to cancel deletion.

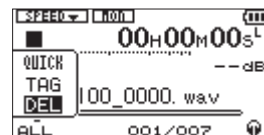

# 10—Settings and Information

## Using the INFORMATION screens

Various information about this unit can be checked on these screens.

- 1 Press the MENU key to open the MENU screen.
- 2 Use the wheel to select INFORMATION, and press the ENTER/MARK key.
- 3 Use the wheel to change the open page.

## File information (FILE)



### WAV/MP3:

File format

- WAV: Bit-length  
Stereo/mono  
Sampling frequency (Hz)
- MP3: Bit-rate (kbps)  
CBR/VBR  
Sampling frequency (Hz)

### NOTE

CBR: constant bit rate

VBR: variable bit rate

### TITLE:

Shows the file name. If an MP3 file has ID3 tag title information that information appears.

### DATE:

Date of file creation

### SIZE:

File size

## Card information (CARD)

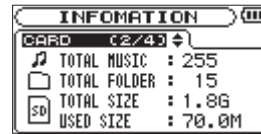

### TOTAL MUSIC:

Shows the number of playable files contained by the Music Folder.

### TOTAL FOLDER:

Shows the total number of folders in the Music Folder.

### TOTAL SIZE:

Shows the total SD card capacity.

### REMAIN SIZE/USED SIZE:

Shows the amount of unused/used capacity on the SD card.

### NOTE

Press the ◀◀ or ▶▶ key to switch between REMAIN SIZE and USED SIZE.

## System information (SYSTEM)



### CUE/REV SPD:

Shows the speed of forward and backward searching.

### AUTO OFF:

Shows the automatic power OFF setting.

### BACKLIGHT:

Shows the automatic backlight OFF setting.

### System Ver.:

Shows the system firmware version.



# 10—Settings and Information

## Battery information (BATTERY)

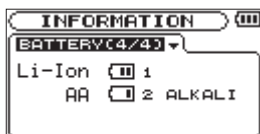

### Li-Ion:

Amount of power remaining, priority (1: main, 2: backup)

### AA:

Amount of power remaining, priority (1: main, 2: backup), battery type setting

When using an AC adapter, the amount of power remaining in the lithium ion battery is not shown. The  icon always appears.

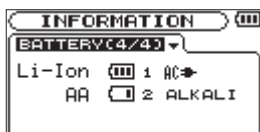

## Using input monitoring (MONITOR)

Normally the unit must be recording or in record standby to monitor the input sound level. In order to conduct overdub recording, however, you need to balance the levels of the playback and input sounds beforehand. This function allows you to monitor the input sound even during playback.

- 1 Press the MENU key to open the MENU screen.
- 2 Use the wheel to select INPUT SETTING, and press the ENTER/MARK key.
- 3 Set the MONITOR item to ON.

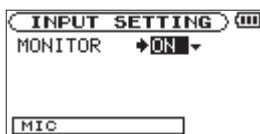

Values: OFF (default), ON

### NOTE

You cannot change this setting during recording or record standby.

## Setting mono input (TYPE)

When recording with just one connected external XLR mic, for example, you can input and record its input signal to both left and right channels.

- 1 Press the MENU key to open the MENU screen.
- 2 Use the wheel to select INPUT SETTING, and press the ENTER/MARK key.
- 3 Set the TYPE item to MONO.

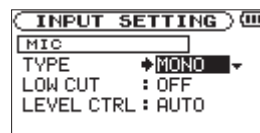

Values: STEREO (default), MONO

### NOTE

If INPUT is set to LINE, recording is always in stereo regardless of this setting.

### CAUTION

When set to MONO, recordings are not made as mono files, but rather as stereo files with identical left and right channels.

## Using the low cut filter (LOW CUT)

This function allows low frequency sounds in the input signal to be reduced.

Turn this ON when there is undesirable noise from air-conditioning or fans, for example.

- 1 Press the MENU key to open the MENU screen.
- 2 Use the wheel to select INPUT SETTING, and press the ENTER/MARK key.
- 3 Use the LOW CUT item to set the low cut filter frequency.

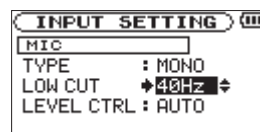

Values: OFF (default), 40Hz, 80Hz, 120Hz

### NOTE

If INPUT is set to LINE, the filter is OFF regardless of this setting.

# 10—Settings and Information

## Using the auto gain control and limiter (LEVEL CTRL)

You can use the auto gain control (AUTO) or limiter (LMT) depending on the application or conditions.

### Auto gain control (AUTO)

Using this, adjustments are made automatically to achieve a volume level that is as even as possible. Sensitivity is raised and lowered depending on the strength of the input signal. This is useful for recording people in a meeting who are at different distances from the microphones, for example.

#### NOTE

When the auto gain control function is on, volume is adjusted automatically, so the INPUT volume control has no effect.

### Limiter (LMT)

If the input signal is too loud, this function holds it down to an acceptable level, allowing distortion of the signal during recording to be avoided.

- 1 Press the MENU key to open the MENU screen.
- 2 Use the wheel to select INPUT SETTING, and press the ENTER/MARK key.
- 3 Set the LEVEL CTRL item to AUTO or LMT.

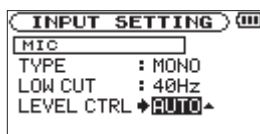

Values: AUTO (default), LMT

- 4 Set the LIMITER/AUTO switch on the back of the unit to ON.

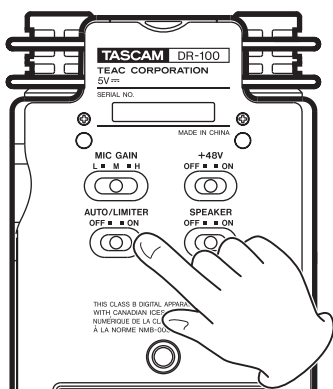

#### NOTE

If INPUT is set to LINE, the limiter is activated regardless of this setting.

## Adjusting the playback level (MIX BALANCE)

You can adjust the level of the playback sound when overdub recording and when input monitoring is ON.

- 1 Press the MENU key to open the MENU screen.
- 2 Use the wheel to select MIX BALANCE, and press the ENTER/MARK key.
- 3 Use the wheel to set the value.

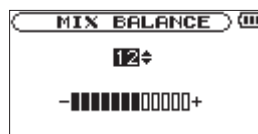

Values: 0–20 (default is 20)

#### CAUTION

You cannot adjust this value when input monitoring is off. (See "Using input monitoring (MONITOR)." on page 41.)

## Setting the file name format

You can set the format of the names given to files when recorded by this unit.

### File name format

- 1 Press the MENU key to open the MENU screen.
- 2 Use the wheel to select FILE NAME, and press the ENTER/MARK key.
- 3 Set the TYPE item to WORD or DATE.

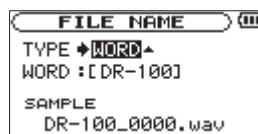

Values: WORD (default), DATE

WORD: Six characters set with the WORD item are used as the file name, for example "DR-100\_0000.wav".

DATE: The date is used as the file name, for example, "090101\_0000.wav".

#### NOTE

The date is determined by the unit's internal clock setting. (See "Setting the date and time" on page 21.)

# 10—Settings and Information

## Setting the file name (WORD)

- 1 Press the MENU key to open the MENU screen.
- 2 Use the wheel to select FILE NAME, and press the ENTER/MARK key.
- 3 Select the WORD item. Use the ◀◀ and ▶▶ keys to move the cursor, and use the wheel to select the characters.

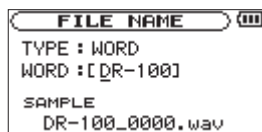

In addition to letters and numbers, the following symbols can also be used.

! # \$ % & ' ( ) + , - . : ; = @ [ ] ^ \_ ` { } ~

## Setting the search speed (CUE/REV SPEED)

You can set the rewind/fast-forward (search) speed.

- 1 Press the MENU key to open the MENU screen.
- 2 Use the wheel to select SETUP, and press the ENTER/MARK key
- 3 Use the CUE/REV SPEED item to set the speed.

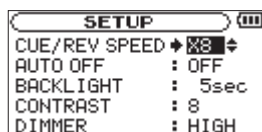

Values: x2, x4, x8 (default), x10

## Turning the power off automatically (AUTO OFF)

You can set the unit to turn OFF automatically after a set amount of time of non-use when operating on battery power.

- 1 Press the MENU key to open the MENU screen.
- 2 Use the wheel to select SETUP, and press the ENTER/MARK key
- 3 Use the AUTO OFF item to set the time.



Values: OFF (default), 3min, 5min, 10min, 30min

## Turning the backlight off automatically (BACKLIGHT)

You can set the backlight to turn OFF automatically after a set amount of time of non-use when operating on battery power.

- 1 Press the MENU key to open the MENU screen.
- 2 Use the wheel to select SETUP, and press the ENTER/MARK key
- 3 Use the BACKLIGHT item to set the time.

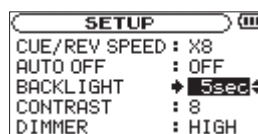

Values: OFF, 5sec (default), 10sec, 15sec, 30sec

## Adjusting the contrast (CONTRAST)

You can adjust the display contrast.

- 1 Press the MENU key to open the MENU screen.
- 2 Use the wheel to select SETUP, and press the ENTER/MARK key
- 3 Use the CONTRAST item to set the value.

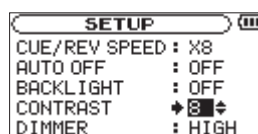

Values: 1–20 (default is 8)

# 10—Settings and Information

## Setting the brightness of the backlight (DIMMER)

You can set the brightness of the backlight.

- 1 Press the MENU key to open the MENU screen.
- 2 Use the wheel to select SETUP, and press the ENTER/MARK key
- 3 Use the DIMMER item to set the value.

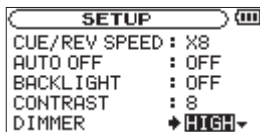

Values: OFF, LOW, HIGH (default)

## Restoring default settings (INITIALIZE)

You can restore the various settings of this device to their factory defaults.

- 1 Press the MENU key to open the MENU screen.
- 2 Use the wheel to select SETUP, and press the ENTER/MARK key
- 3 Press the ►► key at the INITIALIZE item, and then press the ENTER/MARK key to open a confirmation screen.



- 4 Press the ENTER/MARK key again to initialize the unit or press the STOP key to cancel.

## Formatting the SD card

There are two ways to format the SD card in this unit: Quick Format and Full Format.

Formatting an SD card erases all audio files on the card and automatically creates new “MUSIC” and “UTILITY” folders as well as the “dr-1.sys” file.

- 1 Press the MENU key to open the MENU screen.
- 2 Use the wheel to select SETUP, and press the ENTER/MARK key

- 3 Press the ►► key at the QUICK FORMAT or FULL FORMAT item, and then press the ENTER/MARK key to open a confirmation screen.

QUICK FORMAT screen



FULL FORMAT screen



- 4 Press the ENTER/MARK key to initialize the unit or press the STOP key to cancel.

### NOTE

Use a PS-P520 AC adapter (sold separately) or be certain that the unit has plenty of remaining battery power when formatting. Full Format checks for memory errors, so it takes a particularly long time compared to Quick Format.

## Setting the main battery source (MAIN)

When both the lithium ion battery and AA batteries are installed, you can set one as a main power source and the other as a backup. Usually the unit uses the main power source.

When the remaining power of the main battery source becomes low, the unit automatically switches to the backup, allowing continued operation.

The battery source currently used and the amount of remaining power it has are shown at the upper right of the Home Screen.

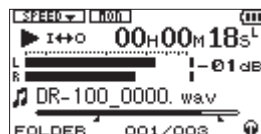

- 1 Press the MENU key to open the MENU screen.
- 2 Use the wheel to select BATTERY, and press the ENTER/MARK key
- 3 Use the MAIN item to set the main battery power source.

# 10—Settings and Information

Values: Li-Ion (lithium ion battery), AA

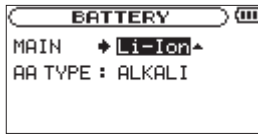

## CAUTION

The power turns off if the backup battery source does not have enough charge. In this case, all recordings, settings and other data will be lost.

## Changing batteries when the power is on

If both the lithium ion battery and AA batteries are installed, you can change batteries while continuing to record and use other functions.

## NOTE

In the following sections, for simplicity we refer to the main "battery" and backup "battery," even though the unit uses two AA batteries. Both AA batteries should be changed together.

## Changing the main battery

Before changing the main battery, confirm that its charge has become low enough that power has switched to the backup battery.

The unit turns OFF if you remove the main battery while it is being used.

If you must change the main battery even though it is in use, change the setting so that the backup battery becomes the main battery and confirm this operation on the Home Screen first.

Confirm that the replaced battery is installed properly before changing the unit setting to make it the main battery.

## CAUTION

If the backup battery charge becomes less than a certain level, you can change the MAIN setting. However, the power source does not change while the unit is recording.

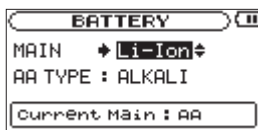

## Changing the backup battery

You can change the backup battery at any time when the main battery is in use, but you should confirm on the Home Screen that the main battery has enough remaining charge.

The unit turns OFF if you remove the backup battery while it is being used.

## Setting the type of AA batteries (AA BATTERY)

You should set the type of AA batteries that you are using. This setting is used to show the amount of remaining battery charge and determine if the unit has enough power for normal operation.

- 1 Press the MENU key to open the MENU screen.
- 2 Use the wheel to select SETUP, and press the ENTER/MARK key
- 3 Use the AA TYPE item to set the type.

ALKALI Alkaline batteries

Ni-MH Nickel metal hydride batteries

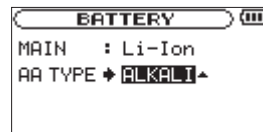

Values: ALKALI (default) Ni-MH

# 10–Settings and Information

## Menu item list

This list provides an overview of the various menu items and their settings that appear on the unit display. The items shown in bold are default setting values.

### MENU screen (press the MENU key)

Menu item	Display/Setting	Settings or explanation
INFORMATION	FILE (1/4)	Information about the file
	CARD (2/4)	Information about the SD card
	SYSTEM (3/4)	Information about the system
	BATTERY (4/4)	Information about the batteries
BROWSE		SD card file operations
PLAYLIST		Playlist editing
PLAY MODE	AREA	Set the area for inclusion in repeat playback ( <b>ALL FILES</b> , <b>FOLDER</b> , <b>PLAYLIST</b> )
	REPEAT	Set the repeat playback mode ( <b>OFF</b> , <b>SINGLE</b> , <b>1 REPEAT</b> , <b>ALL REPEAT</b> )
INPUT SETTING	MONITOR	Set input monitoring ( <b>OFF</b> , <b>ON</b> )
	TYPE	Set the input type for the UNI MIC, OMNI MIC, XLR MIC IN ( <b>STEREO</b> , <b>MONO</b> )
	LOW CUT	Set the low cut filter ( <b>OFF</b> , <b>40Hz</b> , <b>80Hz</b> , <b>120Hz</b> )
	LEVEL CTRL	Set the input level control function ( <b>AUTO</b> , <b>LMT</b> )
REC SETTING	FORMAT	Set the audio file format ( <b>WAV 16bit</b> , <b>WAV 24bit</b> , <b>MP3 32kbps</b> , <b>MP3 64kbps</b> , <b>MP3 96kbps</b> , <b>MP3 128kbps</b> , <b>MP3 192kbps</b> , <b>MP3 256kbps</b> , <b>MP3 320kbps</b> )
	SAMPLE	Set the sampling frequency rate ( <b>44.1kHz</b> , <b>48kHz</b> )
	SIZE	Set the maximum file size ( <b>64M</b> , <b>128M</b> , <b>256M</b> , <b>512M</b> , <b>1G</b> , <b>2G</b> )
	PRE REC	Set the PRE REC function ( <b>OFF</b> , <b>ON</b> )
	DELAY	Set the REC DELAY function ( <b>OFF</b> , <b>ON</b> )
MIX BALANCE	LEVEL	Playback level ( <b>0–20</b> )
DIVIDE		Divide a file
FILE NAME	TYPE	Set the type of automatic file name ( <b>WORD</b> , <b>DATE</b> )
	WORD	Set the characters used when TYPE is set to WORD ( <b>DR-100</b> )
SETUP	CUE/REV SPEED	Set the fast rewind and fast forward speed ( <b>x2</b> , <b>x4</b> , <b>x8</b> , <b>x10</b> )
	AUTO OFF	Set the time before automatic shutdown when running on batteries ( <b>OFF</b> , <b>3min</b> , <b>5min</b> , <b>10min</b> , <b>30min</b> )
	BACKLIGHT	Set the time before the backlight turns off ( <b>OFF</b> , <b>5sec</b> , <b>10sec</b> , <b>15sec</b> , <b>30sec</b> )
	CONTRAST	Set the LCD contrast ( <b>0–20</b> , default is <b>8</b> )
	DIMMER	Set the backlight brightness ( <b>OFF</b> , <b>LOW</b> , <b>HIGH</b> )
	INITIALIZE	Restore the default settings
	QUICK FORMAT	Quick Format the SD card
	FULL FORMAT	Full Format the SD card
BATTERY	MAIN	Set the main battery ( <b>Li-Ion</b> , <b>AA</b> )
	AA TYPE	Set the AA battery type ( <b>ALKALI</b> , <b>Ni-MH</b> )
DATE/TIME		

# 10—Settings and Information

## PB CONTROL screen (press and hold the PB CONTROL key)

Menu item	Display/Setting	Settings or explanation
PB CONTROL	VSA	Set VSA (OFF, ON)
	SPEED	Set the speed (-50—+16%, default 32)

## AUTO REC screen (press the AUTO key)

Menu item	Display/Setting	Settings or explanation
AUTO REC	MODE	Set the operation mode (MARK, PAUSE, TRK INC)
	START LEVEL	Set the level that the unit recognizes as input to record (OFF, -6dB, -12dB, -24dB, -48dB)
	END LEVEL	Set the level below which the unit determines that there is no signal to record (OFF, -6dB, -12dB, -24dB, -48dB)
	END DELAY	Set the time that the unit waits to stop recording after it determines that there is no signal to record (1sec, 2sec, 3sec, 4sec, 5sec)

## List of popup menu items

In addition to regular menus, there are popup menus that appear on other screens.

### BROWSE screen (select a folder and press the ENTER/MARK key)

Overview	Display/Setting	Explanation
Folder operations	SELECT	Set a folder as the active folder
	CREATE	Create a new folder
	ALL DEL	Erase all the files in the folder (folders are not erased)
	CANCEL	Close the popup menu

### BROWSE screen (select a folder and press the ENTER/MARK key)

Overview	Display/Setting	Explanation
File operations	PLAY	Select a file and play it (and return to the Home Screen)
	INFO	Show file information
	ADD LIST	Add a file to the playlist
	DELETE	Erase a file
	CANCEL	Close the popup menu

### PLAYLIST screen (select a file and press the ENTER/MARK key)

Overview	Display/Setting	Explanation
Edit the PLAYLIST	PLAY	Play the selected file
	ALL CLR	Remove all files from the playlist
	DELETE	Remove the selected file from the playlist (file is not erased from the card)
	MOVE	Change the position of the track in the playlist
	CANCEL	Close the popup menu

### Home Screen (press the RECORD key when MONITOR is ON)

Menu	Display/Setting	Explanation
OVERDUB	OFF	Do not overdub
	ON	Record an overdub

### Home Screen (press the QUICK key)

Menu	Display/Setting	Explanation
QUICK	TAG	Add a tag to the file name
	DEL	Delete the file

# 11–Messages

The following is a list of the popup messages that might appear on the DR-100 under certain conditions. Refer to this list if one of these popup messages appears and you want to check the meaning or determine a proper response.

Message	Meaning and response
File Name ERR	The DIVIDE function would cause the file name to exceed 200 characters. The DIVIDE function adds "_a" or "_b" to the end of the file name. Before choosing the DIVIDE function, connect the unit to a computer and edit the file name to less than 198 characters.
Dup File Name	The DIVIDE function would cause the file name to be the same as that of an existing file. The DIVIDE function adds "_a" or "_b" to the end of the file name. Before choosing the DIVIDE function, connect the unit to a computer and edit the file name.
File Not Found	The file added to the playlist cannot be found or a file could be damaged. Please check the file in question.
Non-Supported	The audio file is not a supported format. Please see "8–Connecting with a Computer" for file formats that this unit can use.
Battery Empty	The battery is almost out of power. Recharge the lithium-ion battery and/or replace the AA batteries.
I/O Too Short	The IN and OUT points are too close together. Reset the IN and OUT points with at least 1 second between them.
File Not Found PLAYLIST	The file in the Playlist cannot be found. Please confirm that the file is still in the Music Folder.
No PLAYLIST	No files have been added to the Playlist. Add a file to the Playlist or change the play mode to something besides PLAYLIST.
PLAYLIST Full	The playlist is full. You cannot add more than 99 tracks to the Playlist.
MBR Error Init CARD	The card is not formatted properly or the formatting is broken. Change the card or press the <b>ENTER/MARK</b> key when this message appears to format the card in FAT format. <b>CAUTION</b> Execution of FAT formatting erases all data currently on the card.
Format Error Format CARD	The FAT formatting of the card is abnormal or broken. This message also appears if you FAT formatted the card using a computer connected by USB and if a new card is inserted in the unit. Always use the DR-100 to conduct FAT formatting of cards to be used with it. Change the card or press the <b>ENTER/MARK</b> key when this message appears to format the card in FAT format. <b>CAUTION</b> Execution of FAT formatting erases all data currently on the card.
File Not Found Make Sys File	The system file is missing. This unit requires a system file for operation. When this message appears, press <b>ENTER/MARK</b> to automatically create a system file.
Invalid SysFile Make Sys File	The system file required to operate this unit is invalid. When this message appears, press <b>ENTER/MARK</b> to automatically create a system file.
Invalid Card Change Card	Something might be wrong with the card. Change the card.
Protected Card Change Card	This appears when the card is protected and lacks the necessary Music Folder and other folders and files. Unlock the write protect switch, restart the power and format the card.
Write Timeout	Writing to the card timed out. Backup files on the card to your computer, and format the card.



# 11–Messages

Message	Meaning and response
Card Full	The card has no remaining capacity. Erase unnecessary files or move them to your computer to make open space.
Layer too Deep	Folders can be created down to two layers. You cannot create a new folder inside the current folder.
Can't Divide	The position selected for divide is not suitable (too close to the beginning or end of a track).
Max File Size	The file is larger than the designated size or the recording time exceeded 24 hours.
File Full	The total number of folders and files exceeds 999. Erase unnecessary files or move them to your computer.
Card Error	The card could not be handled properly. Replace the card.
Current File MP3	MP3 files cannot be divided.
File Protected	The file is read only and cannot be erased.
No Card	No card is in the unit, so recording is not possible.
No PB File	There is no file that can be played back. The file might be damaged.
No MUSIC File	There is no playback file, so DIVIDE and OVERDUB cannot be executed.
Not Continued	If any of these errors occur, turn the unit power OFF and restart it. If the power cannot be turned OFF, remove the batteries and disconnect the AC adapter (if connected). If the error message continues to appear, please contact a TEAC Repair Center.
File Error	
Can't Save Data	
Player Error	
Device Error	
Writing Failed	
Sys Rom Err	
Remote Cmd	
Remote Rx	
System Err 50	
System Error 1	
System Error 2	
System Error 3	
System Error 4	
System Error 5	
System Error 6	
System Error 7	
System Error 8	
System Error 9	

# 12—Specifications

---

## Audio input ratings

---

- **XLR MIC IN (L, R) inputs**

Connectors: XLR-3-32equivalent (balanced)

Input impedance: 1.2 k $\Omega$

- **GAIN HIGH setting**

Standard input level: -58 dBu

Maximum input level: -42 dBu

- **GAIN MID setting**

Standard input level: -36 dBu

Maximum input level: -20 dBu

- **GAIN LOW setting**

Standard input level: -14 dBu

Maximum input level: +2 dBu

- **LINE IN input**

Connector: 3.5 mm stereo minijack

Input impedance: 23 k $\Omega$

Standard input level: -10 dBV

Maximum input level: +6 dBV

- **LINE OUT output**

Connector: 3.5 mm stereo minijack

Standard output level: -10 dBV

Maximum output level: +6 dBV

- **⌚ output**

Connector: 3.5 mm stereo minijack

Maximum output : 25 mW + 25 mW

(with 32  $\Omega$  headphone connection)

- **Built-in speakers**

Output: 0.4 W

---

## Audio performance

---

- **Frequency response (LINE IN > LINE OUT):**

20 Hz–20 kHz, +1/-3 dB (44.1 kHz)

20 Hz–22 kHz, +1/-3 dB (48 kHz)

- **Distortion (LINE IN > LINE OUT):**

Less than 0.01%

- **S/N ratio (LINE IN > LINE OUT):**

90 dB or more

- **Compatible audio files:**

MP3 files: 32–320 kbps, sampling frequency 44.1/48 kHz,

VBR playback, ID3 tag support up to Ver 2.4

WAV files: sampling frequency 44.1/48 kHz,

bit length: 16/24-bit

- **Recording media:**

SD cards (64 MB–2 GB) and SDHC cards (4 GB–32 GB)

- **File system:**

FAT partition: FAT16/32

- **Battery life (continuous operation):**

Lithium ion battery (BP-L2):

About 5 hours (recording time)

About 5 hours (playback time)

Ni-MH batteries (HR15/51):

About 4 hours (recording time)

About 4 hours (playback time)

Alkaline batteries (LR6):

About 2 hours (recording time)

About 2 hours (playback time)

(Backlight off, set to 128-kbps mp3.

Varies according to use conditions.)

- **Operation temperature range:**

0–40° C

- **Power consumption:**

1.7 W (MP3 playback)

5.5 W (maximum)

- **External dimensions (mm):**

80 (w) x 153 (h) x 35 (d) (excluding protrusions)

- **Weight:**

290 g (not including batteries)

---

## Accessory (sold separately)

---

- **AC adapter:**

PS-P520

---

## Requirements for connected computers

---

- **Windows:**

Pentium 300 MHz or better

128 MB or more memory

USB port (USB 2.0 recommended)

- **Macintosh:**

266 MHz Power PC, iMac, G3, G4 or better

64MB or more memory

USB port (USB 2.0 recommended)

- **Recommended USB host controller:**

Intel chipset

- **Supported OS:**

Windows: Windows 2000 Professional SP4 or newer,  
Windows XP, Windows Vista

Macintosh: Mac OS X 10.2 or newer

## Dimensional drawing

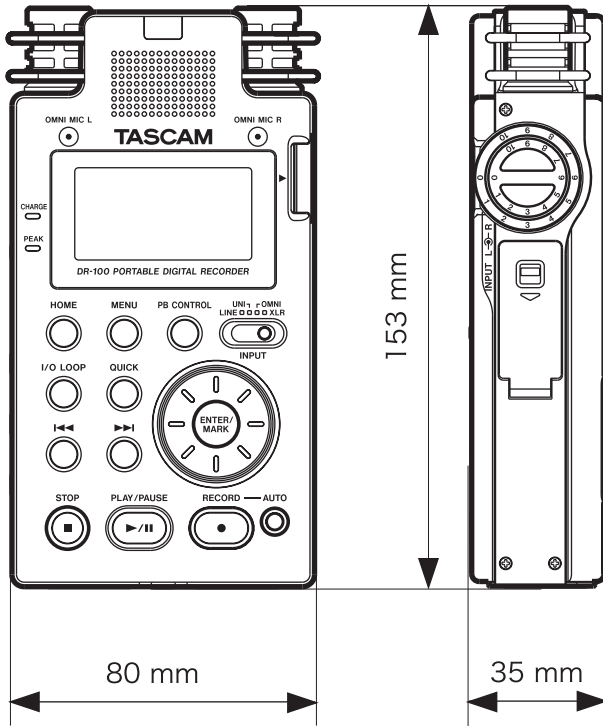

**TASCAM**<sup>®</sup>  
TEAC PROFESSIONAL

# DR-100

Portable Digital Recorder

**TEAC CORPORATION**

Phone: +81-42-356-9143

1-47 Ochiai, Tama-shi, Tokyo 206-8530, Japan

[www.tascam.jp](http://www.tascam.jp)

---

**TEAC AMERICA, INC.**

Phone: +1-323-726-0303

7733 Telegraph Road, Montebello, California 90640 USA

[www.tascam.com](http://www.tascam.com)

---

**TEAC CANADA LTD.**

Phone: +1905-890-8008 Facsimile: +1905-890-9888

5939 Wallace Street, Mississauga, Ontario L4Z 1Z8, Canada

[www.tascam.com](http://www.tascam.com)

---

**TEAC MEXICO, S.A. de C.V.**

Phone: +52-55-5010-6000

Río Churubusco 364, Colonia Del Carmen, Delegación Coyoacán, CP 04100, México DF, México

[www.teacmexico.net](http://www.teacmexico.net)

---

**TEAC UK LIMITED**

Phone: +44-8451-302511

Suites 19 & 20, Building 6, Croxley Green Business Park, Hatters Lane, Watford, Hertfordshire, WD18 8TE, UK

[www.tascam.co.uk](http://www.tascam.co.uk)

---

**TEAC EUROPE GmbH**

Phone: +49-611-71580

Bahnstrasse 12, 65205 Wiesbaden-Erbenheim, Germany

[www.tascam.de](http://www.tascam.de)

---