

TASCAM

TEAC PROFESSIONAL

D01226620C

CC-222MKIV

CD Recorder/Cassette Deck

Professional

OWNER'S MANUAL



MP3

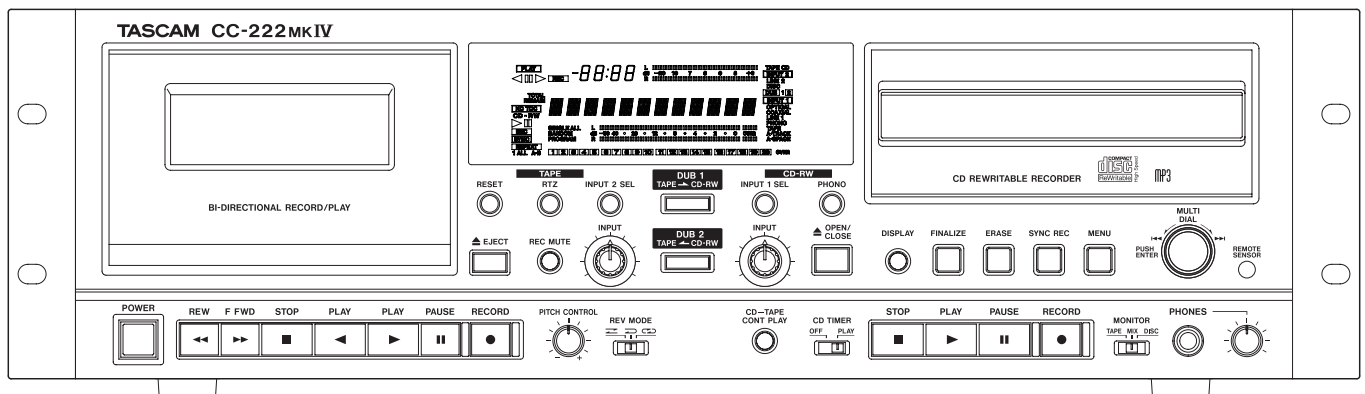

IMPORTANT SAFETY PRECAUTIONS



CAUTION: TO REDUCE THE RISK OF ELECTRIC SHOCK, DO NOT REMOVE COVER (OR BACK). NO USER-SERVICEABLE PARTS INSIDE. REFER SERVICING TO QUALIFIED SERVICE PERSONNEL.



The lightning flash with arrowhead symbol, within equilateral triangle, is intended to alert the user to the presence of uninsulated "dangerous voltage" within the product's enclosure that may be of sufficient magnitude to constitute a risk of electric shock to persons.



The exclamation point within an equilateral triangle is intended to alert the user to the presence of important operating and maintenance (servicing) instructions in the literature accompanying the appliance.

WARNING: TO PREVENT FIRE OR SHOCK HAZARD, DO NOT EXPOSE THIS APPLIANCE TO RAIN OR MOISTURE.

For Canada

THIS CLASS A DIGITAL APPARATUS COMPLIES WITH CANADIAN ICES-003.
CET APPAREIL NUMERIQUE DE LA CLASSE A EST CONFORME A LA NORME NMB-003 DU CANADA.

For U.S.A.

This device complies with Part 15 of FCC Rules. Operation is subject to the following two conditions:

- 1) This device may not cause harmful interference, and
- 2) This device must accept any interference received, including interference that may cause undesired operation.

INFORMATION TO THE USER

This equipment has been tested and found to comply with the limits for a Class A digital device, pursuant to Part 15 of the FCC Rules. These limits are designed to provide reasonable protection against harmful interference when the equipment is operated in a commercial environment. This equipment generates, uses, and can radiate radio frequency energy and, if not installed and used in accordance with the instruction manual, may cause harmful interference to radio communications.

Operation of this equipment in a residential area is likely to cause harmful interference in which case the user will be required to correct the interference at his own expense.

CAUTION

Changes or modifications to this equipment not expressly approved by TEAC CORPORATION for compliance could void the user's authority to operate this equipment.

IN USA/CANADA, USE ONLY ON 120 V SUPPLY.

IMPORTANT SAFETY INSTRUCTIONS

- 1 Read these instructions.
- 2 Keep these instructions.
- 3 Heed all warnings.
- 4 Follow all instructions.
- 5 Do not use this apparatus near water.
- 6 Clean only with dry cloth.
- 7 Do not block any ventilation openings. Install in accordance with the manufacturer's instructions.
- 8 Do not install near any heat sources such as radiators, heat registers, stoves, or other apparatus (including amplifiers) that produce heat.
- 9 Do not defeat the safety purpose of the polarized or grounding-type plug. A polarized plug has two blades with one wider than the other. A grounding type plug has two blades and a third grounding prong. The wide blade or the third prong are provided for your safety. If the provided plug does not fit into your outlet, consult an electrician for replacement of the obsolete outlet.
- 10 Protect the power cord from being walked on or pinched particularly at plugs, convenience receptacles, and the point where they exit from the apparatus.
- 11 Only use attachments/accessories specified by the manufacturer.
- 12 Use only with the cart, stand, tripod, bracket, or table specified by the manufacturer, or sold with the apparatus. When a cart is used, use caution when moving the cart/apparatus combination to avoid injury from tip-over.



- 13 Unplug this apparatus during lightning storms or when unused for long periods of time.
- 14 Refer all servicing to qualified service personnel. Servicing is required when the apparatus has been damaged in any way, such as power-supply cord or plug is damaged, liquid has been spilled or objects have fallen into the apparatus, the apparatus has been exposed to rain or moisture, does not operate normally, or has been dropped.

- The apparatus draws nominal non-operating power from the AC outlet with its POWER or STANDBY/ON switch not in the ON position.
- The mains plug is used as the disconnect device, the disconnect device shall remain readily operable.
- Caution should be taken when using earphones or headphones with the product because excessive sound pressure (volume) from earphones or headphones can cause hearing loss.
- If you are experiencing problems with this product, contact TEAC for a service referral. Do not use the product until it has been repaired.

CAUTION

- Do not expose this apparatus to drips or splashes.
- Do not place any objects filled with liquids, such as vases, on the apparatus.
- Do not install this apparatus in a confined space such as a book case or similar unit.
- The apparatus should be located close enough to the AC outlet so that you can easily grasp the power cord plug at any time.
- If the product uses batteries (including a battery pack or installed batteries), they should not be exposed to sunshine, fire or excessive heat.
- CAUTION for products that use replaceable lithium batteries: there is danger of explosion if a battery is replaced with an incorrect type of battery. Replace only with the same or equivalent type.

WARNING

- Products with Class I construction are equipped with a power supply cord that has a grounding plug. The cord of such a product must be plugged into an AC outlet that has a protective grounding connection.

■ RACK-MOUNTING THE UNIT

Use the supplied rack-mounting kit to mount the unit in a standard 19-inch rack, as shown below.

Remove the feet of the unit before mounting.

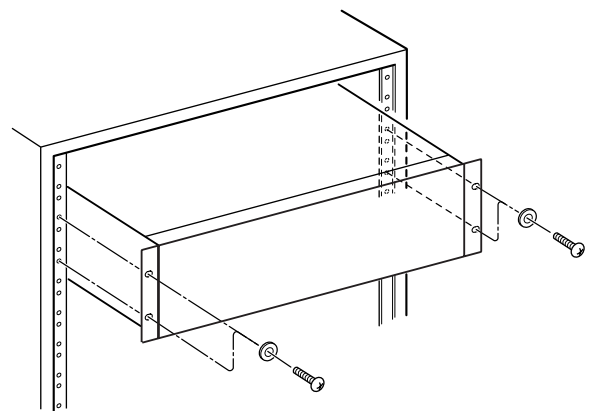

CAUTION

- Leave 1U of space above the unit for ventilation.
- Allow at least 10 cm (4 in) at the rear of the unit for ventilation.

Safety Instructions

■ CAUTIONS ABOUT LASER RADIATION

This product has been designed and manufactured according to FDA regulations “title 21, CFR, chapter 1, subchapter J, based on the Radiation Control for Health and Safety Act of 1968,” and is classified as a class 1 laser product. There is no hazardous invisible laser radiation during operation because invisible laser radiation emitted inside of this product is completely confined in the protective housings.

The label required in this regulation is shown at ①.

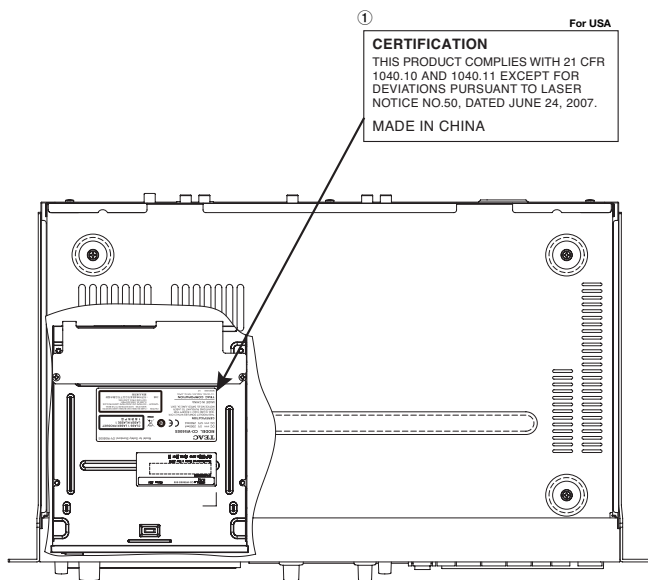

Cautions:

- DO NOT REMOVE THE PROTECTIVE HOUSING USING A SCREWDRIVER.
- USE OF CONTROLS OR ADJUSTMENTS OR PERFORMANCE OF PROCEDURES OTHER THAN THOSE SPECIFIED HEREIN MAY RESULT IN HAZARDOUS RADIATION EXPOSURE.
- IF THIS PRODUCT DEVELOPS TROUBLE, CONTACT YOUR NEAREST QUALIFIED SERVICE PERSONNEL, AND DO NOT USE THE PRODUCT IN ITS DAMAGED STATE.

Optical pickup

Type:	LO-DWH02
Manufacturer:	Lite-space Technology Co., Ltd.
Laser output:	Less than 131.9mW (CD) and 147.8mW (DVD) on the objective lens
Wavelength:	785nm (CD) typical 661nm (DVD) typical
Standard:	IEC60825-1: 2007

■ CAUTIONS ABOUT BATTERIES

This product uses batteries. Misuse of batteries could cause a leak, rupture or other trouble. Always abide by the following precautions when using batteries.

- Never recharge non-rechargeable batteries. The batteries could rupture or leak, causing fire or injury.
- When installing batteries, pay attention to the polarity indications (plus/minus (+/-) orientation), and install them correctly in the battery compartment as indicated. Putting them in backward could make the batteries rupture or leak, causing fire, injury or stains around them.
- When you store or dispose batteries, isolate their terminals with insulation tape or something like that to prevent them from contacting other batteries or metallic objects.
- When throwing used batteries away, follow the disposal instructions indicated on the batteries and the local disposal laws.
- Do not use batteries other than those specified. Do not mix and use new and old batteries or different types of batteries together. The batteries could rupture or leak, causing fire, injury or stains around them.
- Do not carry or store batteries together with small metal objects. The batteries could short, causing leak, rupture or other trouble.
- Do not heat or disassemble batteries. Do not put them in fire or water. Batteries could rupture or leak, causing fire, injury or stains around them.
- If the battery fluid leaks, wipe away any fluid on the battery case before inserting new batteries. If the battery fluid gets in an eye, it could cause loss of eyesight. If fluid does enter an eye, wash it out thoroughly with clean water without rubbing the eye and then consult a doctor immediately. If the fluid gets on a person's body or clothing, it could cause skin injuries or burns. If this should happen, wash it off with clean water and then consult a doctor immediately.
- The unit power should be off when you install and replace batteries.
- Remove the batteries if you do not plan to use the unit for a long time. Batteries could rupture or leak, causing fire, injury or stains around them. If the battery fluid leaks, wipe away any fluid on the battery compartment before inserting new batteries.
- Do not disassemble a battery. The acid inside the battery could harm skin or clothing.

1 – Introduction	6	Recording to disc from the RIAA PHONO inputs	23
Supplied accessories.....	6	Dubbing from tape to disc	24
Some notes, precautions and environmental considerations.....	7	Dubbing to CD from the middle of the tape.....	24
Beware of condensation.....	7	Bypassing the INPUT level for dubbing.....	24
Never use a stabilizer or printable discs.....	7	Advanced recording	25
Handling of compact discs.....	8	Setting the trigger level.....	25
About CD-R and CD-RW discs	8	Using the trigger level	25
About finalizing.....	9	Synchronized recording	26
“Recordable” discs.....	9	Automatic track division	26
About tapes	9	To enable or disable automatic track division: ...	26
About this manual.....	9	Manually divide track.....	26
Use of the remote control unit.....	10	Fade-in and fade-out	27
Batteries	10	To set the fade times:	27
Inserting batteries	10	To perform a fade-in:.....	27
2 – Features of the CC-222MKIV	11	To perform a fade-out:	27
Front panel.....	11	Rec mute function	27
Rear panel.....	12	Copy-protection	27
Display.....	13	6 – After recording	28
RC-222MKIV Remote control unit.....	14	Finalizing	28
3 – Menu operation	15	Unfinalizing CD-RW discs	28
Menu operation.....	15	Erasing	28
Menu configuration	15	Erasing tracks.....	29
4 – Disc operations	16	Erasing a whole disc.....	29
Simple playback operations	16	Refreshing a disc.....	29
Time display modes.....	16	7 – Cassette operating	30
Track search.....	16	Playback operations	30
Playback modes	17	Continuous tape/CD playback.....	30
Random playback	17	Recording operations	31
Program playback.....	17	Dubbing tapes from the CD deck	31
Repeat playback	18	Dubbing to tape from the middle of a CD ...	32
A to B repeat playback.....	18	Recording tapes from the PHONO deck ..	32
Intro check	18	Other recording features	32
Auto spacing	18	Recording silences between items.....	32
Pitch control playback	19	Erasing tapes.....	32
Key control playback	19	Other tape functions and features	33
Playing back MP3 files	20	Tape counter	33
About MP3 track data	20	Pitch control	33
Directory playback setting	20	OUT2 setting (TAPE or AUTO)	33
5 – Recording CDs	21	8 – Reference and specifications	34
Input selection	21	Error messages	34
Signal volume	21	Messages displayed during normal operation	34
Input monitoring	21	Specifications	35
Sampling Frequency conversion	21	CD recorder section.....	35
Basic recording	22	Cassette recorder section	35
Time display while recording	23	Phono input and headphones.....	36
Playing back tracks.....	23	General specifications.....	36
Restricting the number of tracks	23	Dimensional drawing	37
Full disc.....	23		

1 – Introduction

Thank you for your purchase of the TASCAM CC-222MKIV CD Recorder/Cassette Deck.

Before connecting and using the unit, please take some time to read this manual thoroughly to ensure you understand how to properly set up and connect the CC-222MKIV, as well as the operation of its many useful and convenient functions. After you have finished reading this manual, please keep it in a safe place for future reference.

The CC-222MKIV provides you with an advanced system for the recording and playback of digital compact discs and analog cassettes, providing easy duplication facilities in both directions, and combining the most advanced technology in both fields.

Additional audio units, both analog and digital, can be connected easily through the rear panel connections, allowing the recording of other sources.

Additionally, the CC-222MKIV is fitted with a dedicated phono connection, which eliminates the need for an additional RIAA-equipped amplifier when archiving vinyl recordings.

TASCAM's legendary attention to detail provides a high-quality full-featured cassette tape deck.

24-bit digital-to-analog and analog-to-digital converters provide excellent recording and playback quality for the CD recorder.

A sampling frequency convertor is incorporated, allowing the recording of CDs from digital audio sources which are at frequencies other than the CD standard sampling frequency of 44.1 kHz.

Disc track divisions can be entered manually, or can be produced automatically as a response to the input signal level.

“One-touch” fade-ins and fade-outs over a specified time allow you to edit program material to your specific requirements.

A multi-function “multi dial” is used to set and confirm parameter settings.

NOTE

This product is designed to help you record and reproduce sound works to which you own the copyright, or where you have obtained permission from the copyright holder or the rightful licensor. Unless you own the copyright, or have obtained the appropriate permission from the copyright holder or the rightful licensor, your unauthorized recording, reproduction or distribution thereof may result in severe criminal penalties under copyright laws and international copyright treaties. If you are uncertain about your rights, contact your legal advisor. Under no circumstances will TEAC Corporation be responsible for the consequences of any illegal copying performed using the CC-222MKIV.

Supplied accessories

In addition to this manual, the CC-222MKIV has been packed with the following:

- RC-222MKIV remote control unit 1
- AC power cable 1
- AA batteries for the remote control unit 2
- Rack-mounting screw kit (screws and washers) 1
- Owner's Manual (this manual) 1

The warranty is included at the end of this manual.

Contact your TASCAM supplier if any of these items are missing.

Some notes, precautions and environmental considerations

The CC-222MKIV may be used in most areas, but to maintain top performance, and prolong operating life, observe the following notes, precautions and environmental conditions:

- Avoid exposing it to extremes of temperature and humidity and avoid mechanical shocks and vibration.
- Keep the unit away from strong magnetic fields (TV sets, computer monitors, large electric motors, etc.).
- The nominal temperature should be between 5°C and 35°C (41°F and 95°F).
- Relative humidity should be 30 to 90 degrees non-condensing.
- As the unit may become hot during operation, always leave sufficient space above the unit for ventilation. Do not install this unit in a confined space such as a book case or similar product, and do not put any material

goods on the unit.

- Avoid installing this unit on top of any heat-generating electrical device such as a power amplifier.
- Make sure that the unit is mounted in a level position for correct operation.
- The voltage selector on the rear panel is only available on units for the North American market. Please set this to match your local supply. If you are in any doubt in this matter, consult an electrician.

NOTE

When transporting the unit, always use the original packing materials. For this reason, we strongly recommend that you save all the packing materials that came with the CC-222MKIV, in case you need to transport it in the future.

Beware of condensation

If the unit (or a compact disc) is moved from a cold to a warm place, or used after a sudden temperature change, there is a danger of condensation; vapor in the air could condense on the internal mechanism, making correct operation impossible. To prevent this, or if this occurs, let the player sit for one or two hours at the new room temperature before using.

Never use a stabilizer or printable discs

Using commercially available CD stabilizers or printable recordable discs with this player will damage the mechanism and cause it to malfunction.

NOTE

Never use a disc that has had a stabilizer mounted to it. The residual adhesive may cause the disc to stick to the turntable of the CC-222MKIV. If it sticks to the turntable, you will need a technician to get it out.

Trademarks

- TASCAM is a trademark of TEAC Corporation, registered in the U.S. and other countries.
- MPEG Layer-3 audio coding technology licensed from Fraunhofer IIS and Thomson.
- Other company names, product names and logos in this document are the trademarks or registered trademarks of their respective owners.

1 – Introduction

Handling of compact discs

The CC-222MKIV has been designed for the playback of CD-DA format discs and MP3 files recorded in ISO9660 format: In addition to ordinary 5-inch and 3-inch CDs, it can also play properly recorded CD-R and CD-RW discs.

- Always place the compact discs in the trays with their label facing upward.
- To remove a disc from its case, press down on the center of the disc holder, then lift the disc out, holding it carefully by the edges.

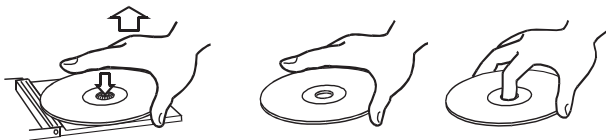

- Avoid getting fingerprints on the signal side (opposite the label side). Grime and dust may cause skipping, so keep discs clean and store them in their cases when not being played. To clean the signal side of a disc, wipe gently with a soft dry cloth from the center towards the outside edge.



- Do not use any record spray, anti-static solutions, benzene, paint thinner or other chemical agents to clean CDs as they could damage the delicate playing surface. It may cause CDs to become unplayable.

- Discs should be returned to their cases after use to avoid serious scratches that could cause the laser pickup to “skip.”
- Keep discs away from direct sunlight, and places of high heat and humidity. If left in such places, warping could result.
- Do not affix any labels or stickers to the label side of the disc. Do not write on the disc with a ballpoint pen.
- Do not insert discs that have adhesive remaining from tape or stickers that have been removed. If they are inserted into the player, they could stick to the internal mechanism, requiring removal by a technician.
- Do not use cracked discs.
- Only use circular compact discs. Avoid using non-circular promotional, etc. discs.

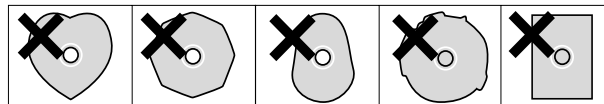

- Music discs with copy control, a compact disc copy-protection system, have been released from several record companies aiming to protect their copyright interests. Since some of these discs do not comply with the CD specifications, they may not be playable on the CC-222MKIV.

About CD-R and CD-RW discs

CD-R discs can be recorded once only. Once they have been used for recording, they cannot be erased or re-recorded. However, if space is available on the disc, additional material can be recorded. The pack-aging of CD-R discs will include one of the following logos:



By contrast, a CD-RW disc can be used in much the same way as a CD-R disc, but the last track or tracks recorded can be erased before the disc has been “finalized”, and the space on the disc can be re-used for other recordings. The packaging of CD-RW discs will include the logo one of the following logos:



However, you should note that an audio CD created using a CC-222MKIV disc may not play back satisfactorily on every audio CD player. It will, naturally, be playable on the CC-222MKIV. This is in no way a limitation of the CC-222MKIV itself, but of the difference between the different types of media and the methods used to read them.

There are precautions that you should take when handling CD-R and CD-RW discs.

- Avoid touching the recording (non-label) side of a disc on which you will be recording. Recording on a disc requires a cleaner surface than playing back, and fingerprints, grease, etc. can cause errors in the recording process.
- CD-R and CD-RW discs are sensitive to the effects of heat and ultraviolet rays. It is important that they are not stored in a location where direct sunlight will fall on them, and which is away from sources of heat such as radiators or heat-generating electrical devices.

1 – Introduction

- Always store CD-R and CD-RW discs in their cases to avoid dirt and dust accumulating on their surfaces.
- When labeling CD-R and CD-RW discs, always use a soft oil-based felt-tipped pen to write the information. Never use a ball-point or hard-tipped pen, as this may cause damage to the recorded side.
- Always keep the recording sides of the discs away from grime and dust to avoid a reduction in sound quality. To clean a disc, wipe gently with a soft dry cloth from the center towards the outside edge. Do not use thinner, gasoline, benzene or LP cleaning fluid, as these will damage the disc and cause the disc unplayable.
- Do not put labels or protective sheets on the discs and do not use any protective coating spray.
- If you are in any doubt as to the care and handling of a CD-R and CD-RW discs, read the precautions supplied with the disc, or contact the disc manufacturer directly.

About finalizing

Although audio data may be written on a CD-R or CD-RW disc, a standard CD player will not be able to read the data (i.e. play back the audio) until a final TOC2 (Table of contents) has been written at the start of the disc.

The process of writing this table of contents is known as “finalizing”. Once this has been done, no further data can be written to the disc. See “Finalizing” on page 28 for details. In the case of a CD-RW disc which has been finalized, the whole of the disc may be erased, or the disc may be “refreshed”, and the disc re-used.

In addition, a CD-RW disc that has been finalized may be “unfinalized”, i.e. only the TOC is removed. This allows further tracks to be recorded to the disc, provided that there is space on the disc.

-
2. TOC: Information of recorded data, which contains titles, starting and ending addresses, and etc..

“Recordable” discs

In this manual, we use the term “recordable” disc to describe a CD-R or CD-RW disc that has not been finalized, i.e. further recording is possible on the disc.

About tapes

Do not store tapes in the following places:

- On top of heaters, exposed to direct sunlight, or in any other places with high temperatures.
- Near speakers, on TV sets or amplifiers or where they would be exposed to strong magnetic fields.
- Where humidity is high, or in dirty, dusty places.
- Avoid dropping or subjecting cassettes to excessive shocks.

As C-120 tapes are mechanically weak, and could become entangled in the transport mechanism, we do not recommend their use.

About this manual

In this manual, we use the following conventions:

- The names of keys and controls are given in the following typeface: **ERASE**.
- When the alphanumeric portion of the display shows a message, this is shown in the following typeface: `Complete`.

- If a preset indicator in the display (i.e. one which cannot change, but is either on or off) is shown, this is shown as follows: `RANDOM`.
- Selectable values (i.e. values in dB) or ON and OFF selections (i.e. `SRC>XXX`) are shown in the following typeface: `XXX`.

1 – Introduction

Use of the remote control unit

- Do not expose the infrared receiver (light receptive area on the front panel) to direct sunlight or intense light for extended periods of time. Long exposure to this light may result in failure of the remote control sensor.
- When the remote control will not be used over one month, please remove the batteries to prevent the possibility of battery acid leakage which could damage the unit. Should leakage occur, remove and discard the batteries, and wipe the battery case thoroughly with a cloth. Avoid getting the battery liquid on the skin. After cleaning, replace with new batteries.
- The remote control functions by using an infrared light signal. When using the unit to control the CC-222MKIV, other devices that are turned on could be operated by its signal.
- If the range of remote operation becomes smaller, or commands do not always function properly, the batteries have become weak and should be replaced. Always replace both batteries with new batteries of the same type.
- Point the remote control to the remote sensor on the main unit. Do not obstruct the path between the remote control and the remote sensor.

Batteries

If batteries are used improperly, or if leakage or breakage occurs, the unit will not function.

Please observe the cautions indicated on the batteries and their packaging to ensure proper usage.

- Confirm + and – polarity and follow the indications when inserting new batteries into the remote control.
- Do not use old and new batteries together.
- Even if the battery is the same size, the voltage may differ. Do not use batteries of different specifications together.
- Do not attempt to recharge batteries that are non-rechargeable.
- Do not open or disassemble batteries, throw them into a fire or put them in water.

■ Inserting batteries

1. Open the lid.
2. Confirm +/- polarity, and insert two AA batteries.
3. Close the lid.

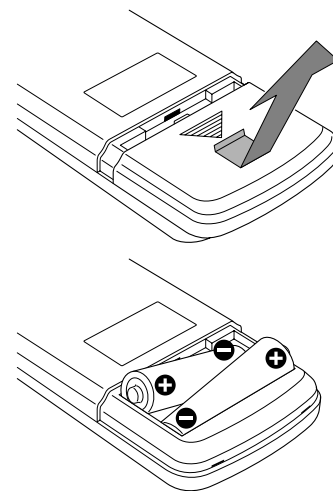

NOTE

The batteries are not supplied for Taiwan.

2 – Features of the CC-222MKIV

Front panel

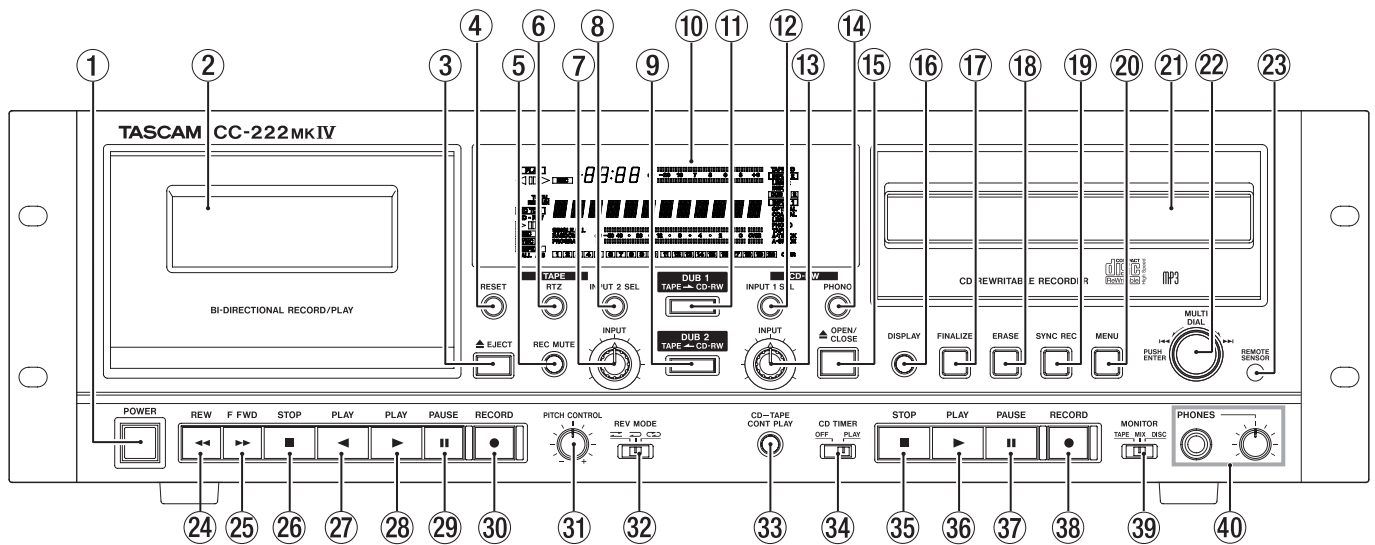

This section provides a brief reminder of the functions provided by these controls.

- ① **Power switch (POWER)** Turns the unit on and off.
- ② **Cassette holder** Open this holder using the **EJECT** key. Insert cassettes tape side downwards, and close the holder by hand.
- ③ **Tape EJECT key** Opens the cassette holder.
- ④ **RESET key** Resets the tape counter to zero.
- ⑤ **REC MUTE key** When recording to cassette and this key is pressed, the sound is muted for about four seconds, and then the unit enters record standby mode.
- ⑥ **RTZ key** Returns the tape to the zero position.
- ⑦ **INPUT (cassette) control** This rotary control affects the level fed to the cassette. Note that it has no effect during automatic disc-to-tape dubbing if the menu item bypassing the volume during dubbing is set to “through”.
- ⑧ **INPUT 2 SEL key** Repeated presses of this key cycles between the different sources available for the cassette recorder: **LINE2** and **DISC**.
- ⑨ **DUB 2 TAPE ← CD-RW key** Starts the process of automatic recording from the disc to a cassette.
- ⑩ **Display** Provides information on the status of the cassette and disc transport and the selected input sources, etc.
- ⑪ **DUB 1 TAPE → CD-RW key** Starts the process of automatic recording from the cassette to a recordable disc.
- ⑫ **INPUT 1 SEL key** Repeated presses of this key cycles through the different sources available for the CD drive: **OPTICAL**, **COAXIAL**, **LINE 1**, **PHONO**, and **TAPE**.
- ⑬ **INPUT (CD) control** This rotary control affects the level fed to the disc. Note that it has no effect during automatic tape-to-disc dubbing if the menu item bypassing the volume during dubbing is set to “through”.
- ⑭ **PHONO key** Starts recording from the phono source to the cassette or disc recorder, depending on the selection made in the menu system. See the appropriate sections on recording to either tape or disc.
- ⑮ **Disc OPEN/CLOSE key** Opens and closes the disc tray.
- ⑯ **DISPLAY key** Changes the time display for the disc recording and playback.
- ⑰ **FINALIZE key** Used when finalizing recordable discs.
- ⑱ **ERASE key** Used when erasing data from CD-RW discs.
- ⑲ **SYNC REC key** Turns synchronized recording of the disc recorder on and off.
- ⑳ **MENU key** Repeated presses of this key cycles through the different menu options.
- ㉑ **Disc tray** Open and close this tray with the **OPEN/CLOSE** key to load and unload discs.
- ㉒ **MULTI DIAL** Used to select and confirm menu settings etc. (turn to make the setting, push to confirm), and also as a track search key when playing back discs.
- ㉓ **REMOTE SENSOR window** Receives the infrared signals from the remote control unit. Do not block this window if you are using the remote control unit.
- ㉔ **REW key** Rewinds the tape moving fast in the right-to-left direction.
- ㉕ **FFWD key** Forwards the tape moving fast in the left-to-right direction.
- ㉖ **Tape STOP key** Stops the current tape transport operation.
- ㉗ **Tape PLAY key (◀)** Starts or resumes tape playback or recording, from right to left.
- ㉘ **Tape PLAY key (▶)** Starts or resumes tape playback or recording, from left to right.
- ㉙ **Tape PAUSE key** Stands by for tape playback or recording. Pressing this key again resumes the operation.

2 – Features of the CC-222MKIV

- ③⑩ **Tape RECORD key** When stopped, pressing this key enters recording standby mode.
- ③① **PITCH CONTROL knob** This is a centerdetented knob which allows the tape speed (and therefore the pitch) to be changed by $\pm 10\%$.
- ③② **REV MODE switch** This three-position switch allows the choice of single-side (—) or bidirectional (↔) playback and recording, or continuous (∞) playback only (not recording).
- ③③ **CD-TAPE CONT PLAY key** Use this to turn continuous playback (alternating between disc and cassette) on and off.
- ③④ **CD TIMER (OFF/PLAY) switch** Use this switch to turn the CD timer option on or off. When this is in the **PLAY** position, turning on the machine with a disc inserted will automatically start playback.
- ③⑤ **CD STOP key** Stops CD playback or disc recording.
- ③⑥ **CD PLAY key** Starts CD playback or recording (from record standby mode).
- ③⑦ **CD PAUSE key** Pauses or resumes CD playback or recording (starts recording from record standby mode).
- ③⑧ **CD RECORD key** Places the disc in record standby mode and performs manual track incrementing while recording.
- ③⑨ **MONITOR (TAPE,MIX,DISC) switch** This switch selects the source for the headphone outputs as either the cassette deck, the disc recorder, or a mixture of both.
- ④① **PHONES jack and volume control** Connect a standard pair of stereo headphones to this 1/4" jack, and adjust the level with the control.

Rear panel

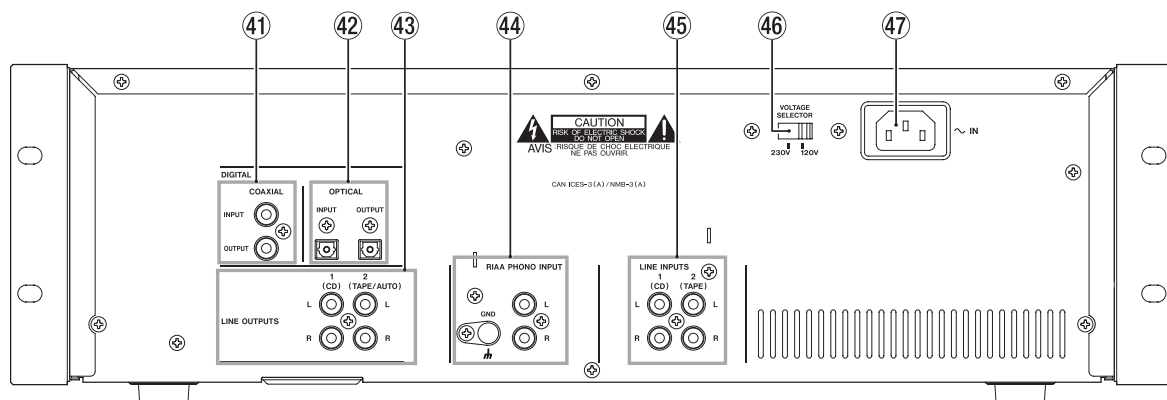

- ④① **DIGITAL COAXIAL (INPUT and OUTPUT) jacks**
These RCA jacks input and output SPDIF digital audio data to and from the disc recorder.

Digital audio data received can be at any sampling frequency between 32kHz and 48kHz. The output is always 44.1kHz.

- ④② **DIGITAL OPTICAL (INPUT and OUTPUT) jacks** These digital optical connectors input and output SPDIF digital audio data to and from the disc recorder.

Digital audio data received can be at any sampling frequency between 32kHz and 48kHz.

- ④③ **LINE OUTPUTS (L,R) / 1(CD), 2(TAPE/AUTO)** Use these connectors to connect the amplifier to the analog outputs of the disc recorder (1) or the outputs of the cassette deck (2).

- ④④ **RIAA PHONO INPUT (L, R) and GND terminal**
Use these connectors to connect a record deck to the CC-222MKIV. The destination of the signal is determined by a menu item.

Connect the earth (grounding) wire of the record deck to the **GND** terminal.

NOTE

Do not connect a record deck to the LINE inputs and do not connect any other equipment to these jacks.

- ④⑤ **LINE INPUTS (L,R) / 1(CD), 2(TAPE)** Use these connectors to connect signal sources to the analog inputs of the disc recorder (1) or the inputs of the cassette deck (2).

- ④⑥ **VOLTAGE SELECTOR switch** Switches the voltage to either 230 V or 120 V.

NOTE

The voltage selector is only available on units for North American market.

- ④⑦ **AC IN jacks** Connects the power cable supplied.

2 – Features of the CC-222MKIV

Display

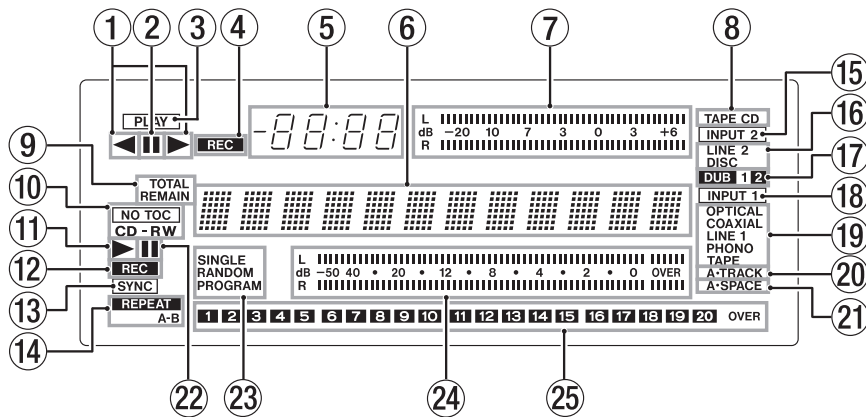

This display shows various types of operation information, including CD disc information, deck operation modes, and menu status.

- ① ◀▶ (Tape-running indicator) Shows the direction of a tape during playback or recording.
- ② **Tape PAUSE (III)** Lights when the unit is in standby mode for tape playback or recording.
- ③ **Tape PLAY** Lights when a tape is being played back or recording.
- ④ **Tape REC** Lights during tape recording or recording standby mode.
- ⑤ **Tape Counter display** The tape counter value is incremented when the tape is moving from left to right, and decremented when it moves from right to left (See “Tape counter” on page 33 for more details).
- ⑥ **Character display** Disc or track information, menu, message, time, and operation status are displayed.
- ⑦ **Tape Level meter** Displays the playback level and the input level of the source device for recording operation.
- ⑧ **TAPE, CD** In the CD-TAPE CONT PLAY mode (continuous CD/tape playback), one of these will flash during playback.
- ⑨ **Counter display** Either TOTAL or REMAIN is lit. When both indicators are off, the time mode is set to show the elapsed time of the current track.
- ⑩ **Disc information display** NO TOC Lights when a disc does not contain TOC (Table of Contents) data. CD, CD-R or CD-RW lights up when a disc with TOC data is loaded.
- ⑪ **CD PLAY (▶)** Lights during disc playback.
- ⑫ **CD REC** Lights during disc recording or recording standby mode.
- ⑬ **SYNC** Lights when the SYNC recording mode is on.
- ⑭ **REPEAT, A-B display** When the Repeat function is on, “REPEAT” is lit. When the A-B Repeat function is on, “REPEAT” and “A-B” are lit. “A-B” also blinks until a “B-point” is entered.
- ⑮ **INPUT 2** This is always displayed except when recording with the PHONO key.
- ⑯ **LINE 2, DISC display** Shows the different sources

available for **INPUT 2** (Tape deck).

LINE 2: a signal source is connected to **LINE INPUT 2**.

DISC: a signal source is connected to internal CD drive.

- ⑰ **DUB 1, 2** When dubbing a tape to a CD-RW, the indicator “DUB 1” lights up. When dubbing a CD-RW to a tape, indicator “DUB 2” lights up.
- ⑱ **INPUT 1** This is always displayed except when recording with the PHONO key.
- ⑲ **OPTICAL, COAXIAL, LINE 1, PHONO, TAPE display** Shows the different sources available for **INPUT 1** (CD drive).
 OPTICAL: Input source is connected to **OPTICAL**.
 COAXIAL: Input source is connected to **COAXIAL**.
 LINE 1: Input source is connected to **LINE 1**.
 PHONO: Input source is connected to **PHONO**.
 TAPE: Input source is connected to internal tape deck.
- ⑳ **A-TRACK** Lights when the Auto Track function is on. The indicator blinks when Time mode is selected.
- ㉑ **A-SPACE** Lights when the Auto Space function is on.
- ㉒ **CD PAUSE (III)** Lights during playback or recording standby mode.
- ㉓ **SINGLE, RANDOM, PROGRAM display** Depending on the playback mode selected. When all the indicators are off, Continuous playback mode is on.
- ㉔ **CD Level meter** Displays the playback or input source level when recording.
- ㉕ **MUSIC CALENDER** Available tracks for playback light up; played back tracks disappear from the screen. When there are more than 20 tracks available for playback, the “OVER” indicator lights up.

2 – Features of the CC-222MKIV

RC-222MKIV Remote control unit

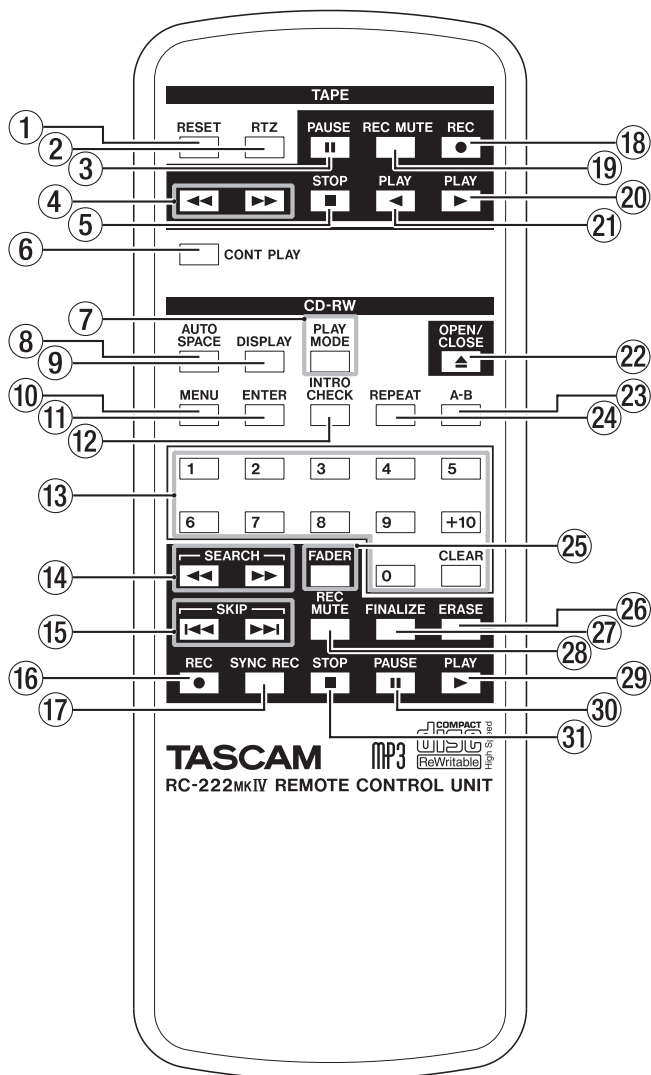

- ① **Tape RESET key** Resets the tape counter to zero.
- ② **Tape RTZ key** Returns the tape to the zero position.
- ③ **Tape PAUSE key** Stands by for tape playback or recording. Pressing this key again resumes the operation.
- ④ **Tape <</>> key** Fast-rewinds or fast-forwards the tape.
- ⑤ **Tape STOP key** Stops the current tape transport operation.
- ⑥ **CONT PLAY key** Use this key to turn continuous playback (alternating between disc and cassette) on and off.
- ⑦ **PLAY MODE key** Allows the selection of either continuous, single, programmed or random playback.
- ⑧ **AUTO SPACE key** Automatically adds a space of about four seconds between disc tracks on playback.
- ⑨ **DISPLAY key** Changes the time display for the disc recording and playback.
- ⑩ **MENU key** Repeated presses of this key shows different menu items.
- ⑪ **ENTER key** Used to confirm menu settings.
- ⑫ **INTRO CHECK key** Allows the first 10 seconds of

every track on a disc to be played.

- ⑬ **Number keys (0 through 10, +10, and CLEAR key)** Use number keys to enter track numbers for disc playback. The **CLEAR** key cancels the last track entered.
- ⑭ **SEARCH <</>> keys** Used for “fast forward” and “fast reverse” through a disc.
- ⑮ **CD SKIP <</>> keys** Used to select tracks or menu parameter values.
- ⑯ **CD REC key** Places the disc in record standby mode and performs manual track incrementing while recording.
- ⑰ **SYNC REC key** Turns synchronized recording of the disc recorder on and off.
- ⑱ **Tape REC key** When stopped, pressing this key enters recording standby mode.
- ⑲ **Tape REC MUTE key** When recording to cassette and this key is pressed, the sound is muted for about four seconds, and the unit enters record standby mode.
- ⑳ **Tape PLAY▶ key** Starts tape playback or recording, from left to right.
- ㉑ **Tape ◀PLAY key** Starts tape playback or recording, from right to left.
- ㉒ **Disc OPEN/CLOSE key** Opens and closes the disc tray.
- ㉓ **A-B key** Use this key to set the start and end points of a repeat loop and to cancel such a loop.
- ㉔ **REPEAT key** Sets the repeat mode (single track, or disc repeat playback) on and off.
- ㉕ **FADER key** Use this key to perform automated fade-in and fade-out when recording to disc. The time is set using menu items.
- ㉖ **ERASE key** Used when erasing data from CD-RW discs.
- ㉗ **FINALIZE key** Used when finalizing recordable discs.
- ㉘ **CD REC MUTE key** During disc recording, pressing this key inserts a silence of about four seconds and pauses recording.
- ㉙ **CD PLAY key** Starts CD playback or recording (from record standby mode).
- ㉚ **CD PAUSE key** Pauses or resumes CD playback or recording (starts recording from record pause mode).
- ㉛ **CD STOP key** Stops CD playback or disc recording.

3 – Menu operation

Menu operation

The following are the menu items that can be set using the **MENU** key. The majority of them affect disc recording.

Pressing the **MENU** key repeatedly cycles through the menu items. Not every menu item is available in every situation (for instance, if a digital input is not selected, the digital direct option is not shown).

1 Press the MENU key until the desired menu is shown on the display.

- 2 Turn the MULTI DIAL to change a value or setting.**
- 3 Push the MULTI DIAL to confirm the change and exit the menu item.**

Alternatively, keep pressing the MENU key until the normal time counter is displayed.

Menu configuration

Menu displayed	Meaning	Default (factory) value	Described in:
CD PITCH	Pitch control setting ON/OFF	OFF	“Pitch control playback” on page 19
PITCH	CD pitch control setting	0.0%	“Pitch control playback” on page 19
CD KEY	Key control setting ON/OFF	OFF	“Key control playback” on page 19
KEY LEVEL	CD key control setting	0	“Key control playback” on page 19
SRC	Sampling rate converter	ON	“Sampling Frequency conversion” on page 21
VOLUME	Digital volume control	0dB	“Signal volume” on page 21
A_TRK	Automatic track increment	LEVEL	“Automatic track division” on page 26
A_TIME	Automatic track increment	1 min	“Automatic track division” on page 26
S_LVL	Sound (trigger) level for track increment	-24 dB (analog) -54 dB (digital)	“Setting the trigger level” on page 25 and “Using the trigger level” on page 25
COPY ID	Copy-protection on recorded discs	1 GEN	“Copy-protection” on page 27
FADE IN	Allows fade in of recorded discs	3s	“Fade-in and fade-out” on page 27
FADE OUT	Allows fade out of recorded discs	3s	“Fade-in and fade-out” on page 27
DUB>VOL	Bypasses (THRU) or enables (ON) internal volume when dubbing from tape to disc or disc to tape	THRU	“Dubbing tapes from the CD deck” on page 31 and “Dubbing from tape to disc” on page 24
PHONO	Sends the PHONO inputs to DISC or TAPE	DISC	“Recording tapes from the PHONO deck” on page 32 and “Recording to disc from the RIAA PHONO inputs” on page 23
MP3 DIR	MP3 directory	OFF	“Playing back MP3 files” on page 20
OUT2	Assign the OUTPUTS2 jacks to TAPE or DISC	TAPE	“OUT2 setting” on page 33

4 – Disc operations

Simple playback operations

WARNING

If you are monitoring using headphones, first adjust the level control to low on the unit, then connect to the PHONES jack before playing back. This will prevent any possible damage to your hearing.

- 1 Press **OPEN/CLOSE** key to open the disc tray.
- 2 Discs should be inserted in the tray with the label up-permost.
- 3 Press the **OPEN/CLOSE** key to close tray.

When a disc is loaded into the unit, the display briefly shows **TOC Reading**, with a flashing period as the unit determines the contents of the disc. When the TOC has been read, the display shows (at the left of the display) one of the following:

CD	Commercial pre-recorded CD
CD-R/CD-RW	Finalized CD-R or CD-RW
CD-R, NO TOC	CD-R which has yet to be finalized
CD-RW, NO TOC	CD-RW which has yet to be finalized

Time display modes

When playing back a CD, or when in standby mode, there are four different time display modes.

In each mode, the current track number is given, followed by the time, as given below, e.g.

10Tr 0:48

Press the **DISPLAY** key to cycle through these time display modes, as described here:

Display shows	Meaning
TOTAL	Total elapsed time of the disc
TOTAL REMAIN	Time remaining of the current disc
[blank]	Elapsed time of the current track
REMAIN	Time remaining of the current track

Track search

Use the **MULTI DIAL** (or the **SKIP** keys on the remote control unit) to jump forward or backward by one track at a time, as shown on the display.

Note that going forward from the last track of the disc will “wrap round” to track 1, and going backward from the first track of the disc will “wrap round” to the last track of the disc.

It is also possible to use the number keys on the remote control unit to jump directly to a particular track:

- 1 To play tracks 1 through 9, simply press the appropriate key (1 through 9).
- 2 To play a track whose number is higher than 9, press the **+10** key an appropriate number of times to

4 Press the **PLAY** key to start playback

The track number indicators at the bottom of the display light, to show the available tracks playing back. If there are thirteen tracks on the disc, for example, indicators 1 through 13 will light. If there are more than 20 tracks on the disc, “OVER” will light at the end of the track number indicators.

Pressing the **STOP** key stops playback.

Pressing the **PAUSE** key pauses playback temporarily. To resume playback, press the **PAUSE** key again or the **PLAY** key.

NOTE

If the Program playback has been selected (see “Program playback” on page 17), the elapsed time and total remaining time refer to the programmed material, not the whole disc.

set the “tens” digit of the track number, followed by a single key to set the “units” digit. For example:

Track 13 = +10, 3

Track 30 = +10, +10, +10, 0

NOTE

On the remote control unit only, the search keys can be used to “fast-forward” and “fast-rewind” through the disc.

Playback modes

The unit can be set to play back a single track, the whole disc in the created order, the tracks of the disc in a random (shuffled) order, or a programmed order. This operation takes place when stopped.

NOTE

Selecting the playback mode is only possible using the remote control unit.

- 1 When stopped, press the **PLAY MODE** key on the remote control repeatedly to cycle the display through the following:
 - **Continue**. Normal playback mode. Playback continues in the normal order.

- **Single**. The currently selected track is played and then playback stops. The **SINGLE** indicator lights in this mode.
- **Random**. In this mode, all the tracks on the disc are played in random order, and the **RANDOM** indicator lights (see “Random playback” on page 17 below).
- **Program**. The **PROGRAM** indicator lights in this mode (see “Program playback” on page 17 below).

The selected mode is shown in large characters and disappears from the display a few seconds after selecting the mode, and the display returns to its previous mode.

Random playback

In this mode, the unit will playback all the tracks on the disc in random order.

- 1 When stopped, press the **PLAY MODE** key until the display shows **Random**.
- 2 Press the **PLAY** key to start random playback.

While playing back, using the track skip function will move forwards through the random order. Turn the **MULTI DIAL** on the unit clockwise or press the **SKIP** (▶▶) key on the remote control.

NOTE

You cannot go backwards to previous tracks in the Random playback mode.

To stop random playback, press the **STOP** key. Opening the disc tray also stops random playback.

Program playback

The steps to set up to 99 program steps (tracks) to be played back in a specified order are as follows:

- 1 When stopped, press the **PLAY MODE** key until the display shows **Program**.
- 2 The display changes to show **0Tr 00:00 00**, meaning that there are no tracks assigned for program playback.
- 3 Use the number keys on the remote control to enter a track number. There is no need to press the **ENTER** key.

The track entered is assigned to the program step, and the display changes, showing the track number, the total time of the program so far, and the step number, e.g. **2Tr 14:56 03**.

- 4 The next program step can then be entered.

NOTE

*Steps 3 and 4 above can also be carried out from the main unit by turning and pushing the **MULTI DIAL** key.*

- 5 Repeat steps 3 and 4 above until the program is complete.
- 6 Press the **PLAY** key to start playback at the first program step.

The display shows the track, the current time display, and the program step number.

While in program playback mode, using the **SKIP keys or the **MULTI DIAL** moves backwards and forwards in the order set in the program.**

Use the **PAUSE** key to stop playback temporarily or the **STOP** key to stop playback of the program. If the **STOP** key is used, when playback is restarted, it starts from the first program step.

When stopped, if the **CLEAR** key on the remote control is pressed, it cancels the last track entered in the program.

Clear the program by pressing the **PLAY MODE** until the display shows **Continue**. The program is also cleared when the disc tray is opened, and if the **STOP** key is pressed when playback is stopped in programmed order mode.

The programmed play order is not memorized when the power is turned off.

If you enter more than 99 program steps, the message **PGM Full !** appears on the display.

If the total time programmed goes over 100 minutes, the message **---:---** appears on the display.

4 – Disc operations

Repeat playback

The unit can repeat the whole of the disc, the current track only, or an A–B portion set as described here. Selecting the repeat mode is only possible using the remote control unit.

NOTE

You can use this mode with Single, Random, or Program playback modes.

- 1 The unit should be in playback, standby or stop mode.

Press the **REPEAT** key so that the display shows **Repeat ON** (the **REPEAT** indicator lights).

To cancel repeat mode, press the **REPEAT** key again so that the display shows **Repeat OFF** and the **REPEAT** indicator goes out.

A to B repeat playback

You can set the points between which playback should loop.

- 1 While playing back, press the **A-B** key on the remote control at the point where the loop is to start (**A-point**).

The **REPEAT** indicator lights up and **A-B** indicator blinks till the second point (**B-point**) is entered.

- 2 Press the **A-B** key again at the point where the loop is to end (**B-point**).

NOTE

If the A and B points are too close together, A-B looping is not possible.

Playback jumps back to the first “A-point” and continues to the second “B-point” and then returns to the “A-point” again, repeating the loop.

Cancel the A-B repeat mode by pressing the **A-B** key, or the **STOP** key. Both indicators will go out.

During playback, if the **A-B** key is pressed, the loop will be canceled and playback will continue past the B-point.

NOTE

A-B repeat cannot be set when the specified section spans more than one track, and cannot be used with MP3 discs.

Intro check

You can skip through the first 10 seconds of all the tracks on a CD to check the contents of the CD.

NOTE

This function is only available from the remote control unit.

- 1 When stopped, in the **Continuous (normal)** mode, press the **INTRO CHECK** key.

The first 10 seconds of each track on the disc will be played back.

- 2 Press the **INTRO CHECK** key again or the **STOP** key to stop this playback process.

NOTE

*In Single or Random playback modes, with the disc stopped, pressing the **INTRO CHECK** key cancels the mode and returns to Continuous playback mode.*

Auto spacing

This function inserts a gap of about four seconds between tracks on playback. This can be useful when recording to tape, so that automatic searching can take place more easily on tapes recorded from disc (see “Search keys” on page 33).

NOTE

This function is only possible using the remote control unit.

Press the **AUTO SPACE** key when in playback, standby, or stop mode, the **A.SPACE** indicator lights on the right side of the display. Pressing the **AUTO SPACE** key again cancels the mode and returns to normal playback.

The **STOP** key also cancels the mode and stops playback.

4 – Disc operations

Pitch control playback

When playing back an audio CD, the pitch (or speed) of the playback can be varied. Pitch can be varied +/- 12.5%.

1. When stopped, press the MENU key to display CD PITCH>XXX.
2. Use the MULTI DIAL on the unit or SKIP key on the remote control to select ON.
3. Press the MENU key to display Pitch> X.X%.
4. Use the MULTI DIAL on the unit or SKIP key on the remote control to adjust the pitch value.

NOTE

Pitch control cannot be used with MP3 discs.

When the unit is in stop mode with CD Pitch control on, when the PLAY or PAUSE key is pressed, the display shows Pitch ON for several seconds (if CD Pitch control and CD Key control are on, Pitch/Key ON appears on the display for seconds).

When the unit is writing data to a disc, the Pitch control function does not work. However, the Pitch control menu can be operated.

Key control playback

The key of the music can be changed during stop, playback or playback standby modes. However, please note that this feature does not work with MP3 discs.

1. Press the MENU key to display CD KEY>XXX.
2. Use the MULTI DIAL on the unit or SKIP key on the remote control to select ON.
3. Press the MENU key to display KEY LEVEL>XXX.
4. Use the MULTI DIAL on the unit or SKIP key on the remote control to adjust the key value.

The playback key can be raised or lowered 1/2 octave in half-tone increments. Selection values: 0 (no change), b1 to b6, #1 to #6.

NOTE

In this condition, when a CD is played back, the key of the music is changed while the speed of the music remains the same.

When the Key control function is on, only the playback speed changes when you use the Pitch control function, and the key of playback will remain fixed. (The key of playback will be fixed to the level set by KEY LEVEL>XXX.) Therefore, if you set KEY LEVEL>XXX to 0 and turn on the Key control function, you can change only the playback speed without changing the key of playback.

When the unit is in stop mode with CD Key control on, when the PLAY or PAUSE key is pressed, the display shows Key ON for seconds (if CD Key control and CD Pitch control are on, Pitch/Key ON appears on the display for seconds).

When the unit is writing data to a disc, the Key control function does not work. However, the Key control menu can be operated.

When using the key control function, the volume of the playback sound may occasionally sound like it is vibrating. This is a result of the key control algorithm working on the CD playback sound and is normal.

4 – Disc operations

Playing back MP3 files

MP3 files recorded onto a CD are handled the same way as files are handled in an ordinary PC, with some MP3 files held within a directory. In addition, several directories can be combined into one directory. This results in multiple layers of directories and files.

NOTE

MP3 file formatted at 44,1 kHz sampling rate and 128 kbps or higher are required, otherwise, that MP3 file cannot be played back.

Each MP3 file is handled as a track.

When the Directory mode is on, only those files within a selected directory are available for playback.

When the directory mode is off, the directory configuration is ignored, and all MP3 files recorded on the disc are available for playback. Please note that Program playback and Repeat playback only function within directories.

NOTE

Directories which do not contain MP3 files directly under them cannot be selected for playback. For example, in the diagram below, under directory A are directory B and C containing MP3 files in both directories which can be selected for playback. However, directory A showing 0Tr for its total track number cannot be selected for playback.

When an MP3 disc is created in an ordinary PC, mostly, the files (tracks) are shown in the alphabetic order. However, the CC-222MKIV gives track numbers to MP3 files in the order that the files were written on the disc, so the file order shown on this unit may be different from the ones on PC.

The CC-222MKIV can play back MP3 files recorded in formats which conform to ISO9660 level 1, level 2, and the Joliet extensions. Discs recorded in multiple sessions may also be played back.

For MP3 CDs to be played by this unit, the following limitations have been placed on the number of MP3 files and directories.

Maximum number of directories: 255

Maximum number of hierarchical structures: 8

Maximum number of MP3 files: 999

Maximum title size of MP3 files and directories: 255

■ About MP3 track data

On this unit, file name or MP3 TAG information (track title, artist name, etc.) can not be displayed.

The time display mode for MP3 is only [blank], showing elapsed time of the current track.

Example of MP3 file structure

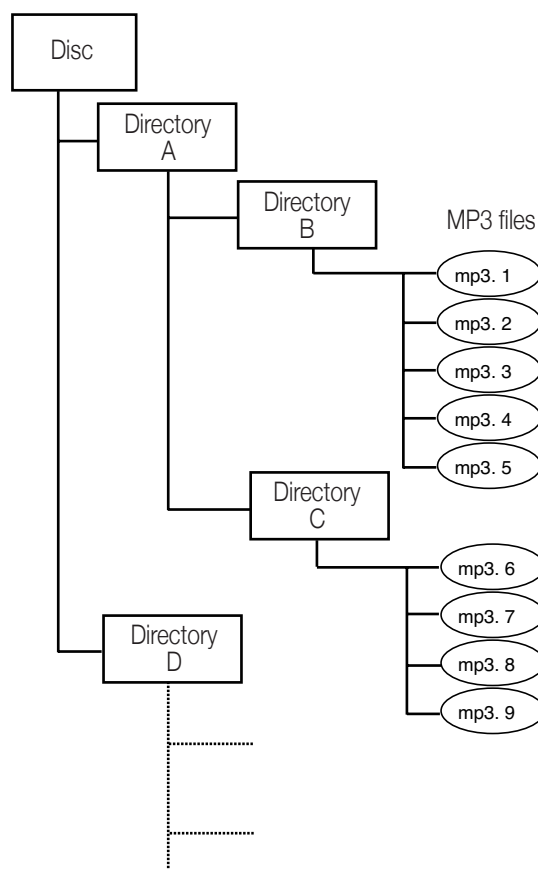

Directory playback setting

1. Press the MENU key until MP3 DIR>XXX appears on the display.
2. Turn the MULTI DIAL to set the value to ON, and push to enter. The total number of track will be shown.
3. Use the MULTI DIAL or SKIP keys to select desired directory for playback.

The display briefly shows MP3 DIR>XXX where the value is directory number.

As the display disappears and return to normal mode, the last directory shown on the screen will be played back.

NOTE

A directory containing no MP3 files will be visible, but it will show 0Tr for its total track number.

4. Press the PLAY key to start playback in the directory. Program or Repeat playback can be operated in the selected directory also.

5 – Recording CDs

Before you start recording using the CC-222MKIV, make sure that you understand the following key points:

- Once you have recorded on a CD-R disc, the data cannot be erased from it.

- You can add tracks to an unfinalized recordable disc. Once finalized, a CD-R disc is “fixed” and behaves in the same way as a pre-recorded disc. Finalized CD-RW discs, however, can be erased, refreshed and re-recorded.

Input selection

To select the input to be recorded, press the **INPUT 1 SEL** key on the main unit.

Repeated presses of the key cycles through the following options:

OPTICAL	Optical digital in
COAXIAL	Coaxial digital in
LINE 1	Analog in (LINE 1)
PHONO	Phono inputs
TAPE	CC-222MKIV cassette deck

In the case of either the coaxial or optical inputs being selected, the appropriate indicator: COAXIAL or OPTICAL, lights on the right of the display.

If an analog signal is selected, the LINE 1 or TAPE indicator lights on the right of the display.

Signal volume

- The analog signals received at the **LINE 1** jacks, the **RIAA PHONO** jacks and from the tape (if the input volume is not being bypassed—see below) are controlled with the CD deck’s **INPUT** control. When this control is at the 12 o’clock position, the signal is neither cut nor boosted.
- The level of the digital inputs may be controlled using the digital volume menu, as described below.

- 1 Press the **RECORD** key to place the unit in record standby mode.
- 2 Repeatedly press the **MENU** key until the display shows **VOLUME >XXXdB** where **XXX** is the current setting.

- 3 Use the **MULTI DIAL** or **SKIP** keys to adjust the input level. The maximum boost is +18 db, and the signal may be cut by up to 60 dB. There is also a ---dB setting which represents a complete signal cut.

NOTE

The digital volume menu can be used for analog inputs, however, using the CD deck’s INPUT control to adjust analog inputs with the digital volume set to zero is recommended.

The level set for digital inputs is not applied to analog inputs and vice versa. If analog inputs are selected after setting digital input level, the set value is ignored and the value previously set for analog inputs returns.

Input monitoring

When the unit is in record standby mode, or record mode, the input signal is output from the **OUTPUT** jacks (digital and analog), allowing you to hear the input signal.

The meters also show the current signal level.

However, it is only possible to record, or to enter record standby mode, when a recordable disc is inserted. To allow monitoring of the input signal at other times, or when the unit is stopped, use the **RECORD** key on the main unit

or remote control to enter monitor mode from stop mode when there is no recordable disc in the unit (when there is a recordable disc in the unit, pressing the **RECORD** key enters record standby mode).

The word **MONITOR** appears on the display to show that the output signal is an echo of the input signal(s). The meters show the current input level.

Exit the monitor mode by using the **STOP** key.

Sampling Frequency conversion

The sampling frequency for CDs is 44.1 kHz. The CC-222MKIV will always record (and play back) CDs at this frequency.

However, if recording through a digital connection (either coaxial or optical) and the source has been recorded at a frequency other than 44.1 kHz, or is being played back at a non-standard speed using a varispeed unit, the CC-222MKIV’s internal frequency converter: SRC (Sampling Rate Converter), converts the incoming frequency to 44.1 kHz.

- 1 Press the **MENU** key repeatedly until the **SRC >XXX** appears.
- 2 Turn the **MULTI DIAL** to set the value **ON** or **OFF**.

NOTE

*When the SRC setting is off, the frequency converter is bypassed. In this case, digital signals other than 44.1kHz cannot be recorded. If an attempt is made, the error message **Not Fs44.1k!** will appear on the display.*

5 – Recording CDs

Basic recording

WARNING

If you are monitoring using headphones, first adjust the level control to low on the unit, then connect to the PHONES jack before playing back. This will prevent any possible damage to your hearing.

NOTE

According to the “Red Book” (the specification for audio CDs), a track cannot be less than four seconds in length, and there can be a maximum of 99 tracks on an audio CD. Bear these limitations in mind when recording.

If you press either the STOP or PAUSE key within four seconds of starting recording, the unit will continue recording until four seconds have elapsed (since the start of recording) and then stop or pause as appropriate.

After selecting the input source(s) (see “Input selection” on page 21), it is possible to start recording.

The basic record procedure is as follows:

- 1 Load a recordable disc into the unit. As the disc is loaded, the display shows `TOC Reading`.
When the disc has been loaded, the display indicators show `CD-R`, `NO TOC`, or `CD-RW`, `NO TOC`, as appropriate.
- 2 Press the RECORD key. The unit enters record standby mode, as shown by the `REC` indicators on the display.
When the display shows `Now OPC`, the unit is operating in OPC (Optimum Power Control).
- 3 Adjust the level of the source(s), following the guidelines in “Signal volume” on page 21.

NOTE

The red `OVER` indicators on the meters should never light. Unlike analog equipment, digital audio units produce unpleasant sounds when distorted, and there is no “headroom” after the 0 mark. If recording digitally from a commercially-produced CD, the volume set in the menu should be `0dB`. This will maintain all the dynamic range of the source CD without clipping. Only boost the signal if the source is exceptionally quiet.

An analog signal input at nominal level, with no cut or boost from the volume controls, is equivalent to a reading of `-16 dB` on the meters (on other words, 0 is equivalent to `16 dBFS`).

- 4 Press the PLAY key or the PAUSE key to start recording.
Note that there is no need to “cue up” the recording position—the unit always finds the next available location on the disc and start recording to it.
- 5 Press the PAUSE key to pause recording temporarily. The pause indicator on the display appears.
Pressing the PAUSE or PLAY key again restarts recording with a new track number.

- 6 Press STOP to stop recording. When recording stops, the display shows `PMA Writing` (Program Memory Area) and the `REC` indicator blinks for a few seconds as the unit writes to the disc.

NOTE

While the “PMA Writing” message is displayed, all keys are disabled, and the unit is actually writing to disc. Do not disconnect the power or subject the unit to severe vibration or shocks at this time, as this will prevent proper recording of the information.

- 7 When this message disappears, you must press the RECORD key (step 2) before restarting the recording. Recording restarts with a new track number.

NOTE

Remember that every time recording is paused or stopped, when recording is restarted, a new track will always be started. It is not possible to record in two “stages” within one track.

Time display while recording

During recording, three options are available for the time display modes.

When in record or record standby mode, repeated presses of the **DISPLAY** key cycles through displaying the remaining time left for recording on the disc (**TOTAL REMAIN**),

the elapsed time of the track currently being recorded (no indicator lit) and the total time recorded on the disc (**TOTAL**).

NOTE

*In record mode, **REMAIN** shows the same time display as **TOTAL REMAIN**.*

Playing back tracks

Although an unfinalized disc cannot be played back on an ordinary CD player, the CC-222MKIV can play back tracks

that have been recorded. Use the **MULTI DIAL** control or the **SKIP** keys to select a track for playback.

Restricting the number of tracks

When making a recording, it is possible to restrict the number of tracks that may be recorded at one time.

At any time within record or record standby mode, turn the **MULTI DIAL** control or use the **SKIP** keys.

This sets the number of remaining tracks, as shown to the right of the time display.

The maximum number can be entered is 99 tracks

Every time a track division is made, the number shown at the right of the display goes down by one.

The number of remaining tracks can be changed during recording using the **MULTI DIAL** control.

Full disc

If the disc becomes full during recording, the unit will automatically insert a fade-out. For example: When recording a long program, just before the end of the disc is reached, the unit starts a fade-out over four seconds and the display will show **Fade Out**.

When the fade-out has finished, the display shows **Disc Full!**. Press the **STOP** key to exit.

If the disc is a CD-RW, the final track can be erased, if required (see “Erasing” on page 28) and the disc then finalized. If the disc is a CD-R, it must be finalized prior to use (see “Finalizing” on page 28).

Recording to disc from the RIAA PHONO inputs

NOTE

Because of the background noise often experienced when playing back analog vinyl recordings, the use of the following features is not recommended in the phono recording mode even though they are available: trigger level, sync recording and automatic track division.

To record to disc from an external record player connected to the **RIAA PHONO INPUT** jacks:

- 1 Load a recordable disc and put the unit in stop mode.
- 2 Press the **MENU** key until the **PHONOXXXX** menu item is shown.

Turn the **MULTI DIAL** (or press the **SKIP** keys on the remote control) to select **DISC**. Prepare to play the record on the external record player.

- 3 Press the **PHONO** key. The **INPUT 1**, **PHONO** indicator lights on the display, and the disc recorder enters record standby mode.
- 4 Start playing back the record.
- 5 Start recording on the disc by pressing the disc **PLAY** key.

The level can be adjusted using the CD deck's **INPUT** control.

Recording will stop when the recording time on the disc ends, or when the disc **STOP** key is pressed.

Also, the **RIAA PHONO** input source will be canceled.

NOTE

*Only the disc **STOP** key is enabled in this phono recording mode. The **RECORD** key therefore cannot be used for manual track increments (see “Manually divide track” on page 26). If you want to use manual track division, use the normal recording procedure, with the phono inputs selected as the source.*

This mode cannot be entered if a recordable disc is not loaded in the drive.

It is also possible to perform manual recording to disc from the **RIAA PHONO INPUT** source. This is the same as the standard manual recording procedure (“Basic recording” on page 22), except that the **PHONO** input option should be selected using the **INPUT 1 SEL** key before recording starts.

5 – Recording CDs

Dubbing from tape to disc

When dubbing from tape to disc, follow the instructions here.

- 1 Load the tape with the side that will be recorded first to be played first. Set the noise reduction, reverse mode, etc. Also, check the MONITOR is set DISC.
- 2 Load a recordable disc.
- 3 Use the MENU key until DUB>VOL appears on the screen. Use the MULTI DIAL to select THRU to bypass the input level control (see “Bypassing the input level for dubbing” on page 24).

If you want to adjust the input volume, set the DUB>VOL menu to ON and use the CD deck’s INPUT control to adjust the level of signals. If you wish to adjust the volume before recording starts, put the CD-RW into record standby or Monitor mode (see “Input monitoring on page 21”) and use the INPUT 1 SEL key to select TAPE.

- 4 Press the DUB 1 key.

The CD goes into record standby. The tape rewinds to the start of the tape and starts playing back. The CD recorder starts recording.

- 5 When the available recording time on the disc is finished, or the tape has stopped, then recording will stop on the disc.

You can also stop the dubbing process by pressing either of the STOP keys.

NOTE

A recordable disc must be loaded in the drive. The DUB 1 key is disabled if the media are not loaded, and if the drives are in any mode other than stop.

Dubbing to CD from the middle of the tape

- 1 To record from the middle of the tape, set noise reduction, reverse mode, etc. and locate the tape to the position where playback will start.
- 2 Press the tape PAUSE key to leave the tape in paused mode.
- 3 With a recordable disc in the drive, press the DUB 1 key. The tape will start playing back, and the disc will start recording.

Recording stops under the same circumstances as for the whole tape (end of tape, end of disc or either STOP key pressed).

Bypassing the INPUT level for dubbing

The input control can be bypassed so that it has no effect when dubbing, in the following way:

- 1 Press the menu key until the DUB>VOL item appears.
- 2 Turn the dial to select THRU, the control is bypassed and disabled.

NOTE

This setting applies only to dubbing procedures, not to other recordings.

It is not possible to make this menu setting (or other menu settings) when dubbing is actually taking place.

Advanced recording

Setting the trigger level

The signal level which may be used with synchronized recording operations (here called the “trigger level” or “threshold”) is set as below:

- 1 With a recordable disc loaded, press the MENU key until the display shows: S_LVL>-XXdB, where -XX is the current value.
- 2 Turn the MULTI DIAL control or use the SKIP keys to change the value between -24, -30, -36, -42, -48, -54, -60, -66, and -72 dB (-60, -66 and -72 are only for digital signal).

Low numerical values of this setting (towards -24) mean that it takes a louder signal to trigger the start of the synchronized recording. A high numerical value (towards -72) means that a relatively quiet signal will trigger the start of recording.

When a digital source is selected, there is another option, DD, which means that any digital signal above the zero level will trigger the recording.

Using the trigger level

An input signal used as trigger to start recording is the sound level rises above the threshold for one second or more:

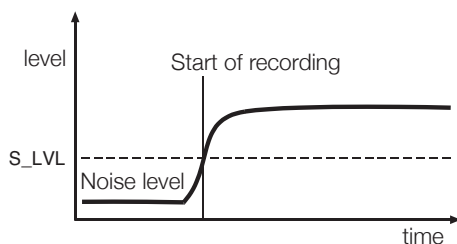

If the “noise floor” is higher than the threshold, synchronized recording will not take place.

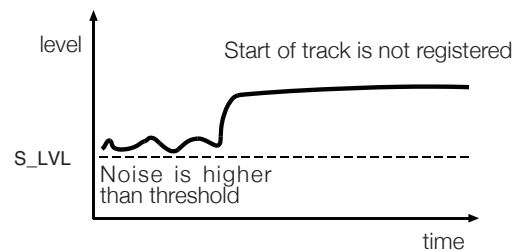

Synchronized recording stops when the sound level drops below the threshold for five seconds:

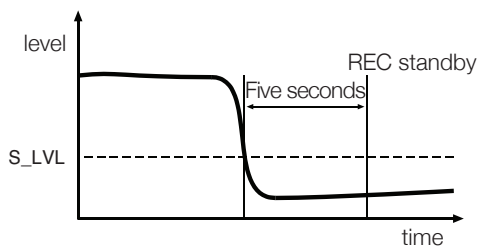

If you set the threshold value so that only high-level signals trigger recording, remember that this will not record the start of a piece which has a slow fade-in:

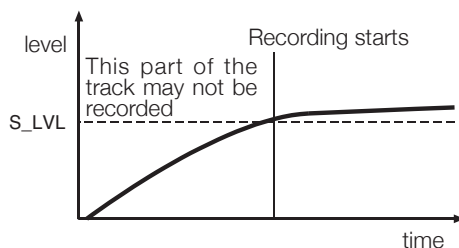

NOTE

Remember that when recording from an analog source, the threshold should be set so that it is higher than the “noise floor” such as the base level of hiss, pops and crackles which may come from an older vinyl recording, for example. However, synchronized recording is not recommended with the PHONO mode (see “Recording to disc from the RIAA PHONO inputs” on page 23).

If you want to prevent the “five seconds” at the end of recording, try restricting the number of tracks using DD mode (see “Restricting the number of tracks” on page 23 and also “Automatic track division” on page 26). This will stop recording immediately so the “five seconds” will not be recorded. When there are no tracks left to be detected in DD mode, you need to make an extra track on the source media before recording.

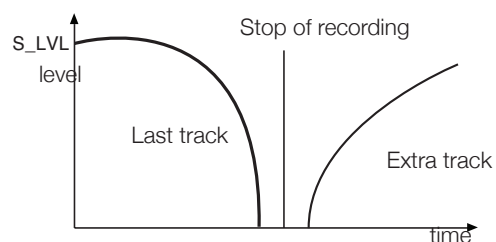

5 – Recording CDs

Synchronized recording

Synchronized recording basically means that recording will begin automatically when a signal is received, and will stop when the signal ends.

To enable or disable synchronized recording:

- 1 A recordable disc must be loaded.
- 2 With the unit in record standby mode or record mode, press the SYNC REC key.

The display shows SYNC ON briefly, and then changes to the track and time display. When syn-

chronized recording is enabled, the SYNC indicator lights in the display.

The SYNC REC key is also used to turn off synchronized recording.

Automatic track division

The trigger level can also be used to divide tracks if the auto track function is enabled.

NOTE

When recording Vinyl to CD, since the track divisions are determined by relative silence, it is possible that spurious track divisions will be inserted. Under these conditions, it may be better to set this function off, and use manual track division explained below.

When this function is enabled, the unit automatically inserts a track division in the recorded material. Following modes are available for this function, and are displayed as described.

• LEVEL

When the sound level has dropped below the threshold for more than two seconds, and sound has re-started, the track will be divided.

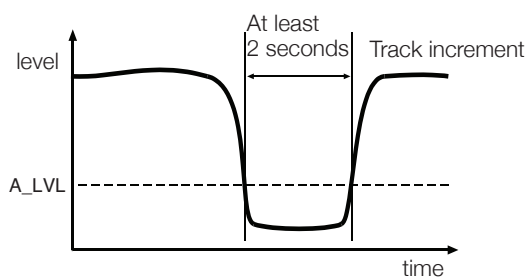

• DD (digital direct)

When recording digitally from MD, CD or DAT, this mode detects a track boundary and divides the track.

However, when the DD mode is on, and if the analog source or non-DAT/CD/MD digital connections are detected, the track number will be incremented using level detection.

• TIME

The track will be incremented as passing the time set before recording using “A_TIME” in the menu items (see “Menu operation” on page 15). The time can be set 1 minute to 10 minute increased by a minute.

• OFF

This sets the function disabled (no indicator lit).

■ To enable or disable automatic track division:

- 1 While record standby mode, press the MENU key repeatedly until the display shows A_TRKXXXX where XXXX is the current setting.
- 2 Use the MULTI DIAL or SKIP keys to select the desired auto track setting.

The A_TRACK indicator lights at the right of the display.

When the TIME mode is selected, the indicator will blink.

Manually divide track

While recording is taking place, press the RECORD key. The current track number is incremented by one.

NOTE

This operation cannot be applied while recording track 99.

Fade-in and fade-out

To provide smooth beginnings and endings to recorded tracks, the unit provides fade facilities.

Fade-ins are from $-\infty$ (silence) to the set input level (see “Signal volume” on page 21) and fade-outs go from the current input volume to silence.

The fade-in and fade-out times can be set independently in increments of one second, from 1 second to 24 seconds.

■ To set the fade times:

- 1 Press the MENU key repeatedly until the display shows FADE IN >XXs, where XX is the current fade-in time, in seconds.
- 2 Turn the MULTI DIAL or use the SKIP keys to change the value of the fade-in time.
- 3 Press the MENU key again so that the display shows FADE OUT>XXs, where XX is the current fade-out time, in seconds.
- 4 Turn the MULTI DIAL or use the SKIP keys to change the value of the fade-out time.

It is possible to set the fade-in time only or the fade-out time only.

■ To perform a fade-in:

- 1 With a recordable disc loaded, press the RECORD key to enter record standby mode.

- 2 Start the source material, and press the FADER key on the remote control.

The display shows FADE IN for the time specified in the menu item above.

As the fade progresses, the monitored signal gradually becomes louder, reflecting the level recorded on disc.

■ To perform a fade-out:

- 1 While recording, press the FADER key. The display shows FADE OUT for the time specified in the menu above.

As the fade progresses, the monitored signal gradually becomes quieter, reflecting the level recorded on disc.

- 2 When the end of the fade-out time is reached, the unit goes into record standby mode. Recording can be restarted with the FADER key or the PLAY or PAUSE keys.

The FADER key can be used and also the fade-in and fade-out times can be reset to new values while recording is in progress.

Rec mute function

The rec mute function allows instant cut-off of the input signal, and records four seconds of silence on the disc.

- 1 While recording is in progress, press the REC MUTE key.
- 2 After about four seconds, the unit enters record standby mode.

NOTE

This function is only available from the remote control unit. It is not possible to use this function with the main unit only.

Copy-protection

The CC-222MKIV allows copy-protection to be applied to the discs produced. Naturally, the copy-protection applies only to digital-to-digital copies.

There are three settings:

- FREE (may be freely copied), where no copy-protection is applied to the recorded disc.
 - IGEN (single-generation copying), where one digital copy (“child”) can be made from the recorded disc, but no digital copies (“grandchildren”) can be made from the child.
 - PROH (copy prohibited) which prevents any digital copies being made from the recorded disc
- 1 Press the MENU key repeatedly until the display shows COPY ID>XXXX, where XXXX is the current setting for copy-protection as shown above.

- 2 Turn the MULTI DIAL or use the SKIP keys to change the copy-protection setting.

NOTE

Copy-protection applies on a “per-track”, not a per-disc basis. This means that you can apply different copy-protection levels to different tracks (but you can’t apply different copy-protection levels to different parts of the same track). If copy-protection is important to your work, you may want to check this setting every time you make a recording, to ensure that you have the protection level that you want.

6 – After recording

This section deals with the actions taken after recording: finalizing for CD-R and CD-RW discs, and erase operations for CD-RW discs.

Once finalized, CD-R discs are truly final—no more can be recorded on them. By contrast, CD-RW discs can be “unfinalized” using the CC-222MKIV, that is, their TOC

can be deleted, and if there is space, further material can be recorded on them. Even if the disc is full, tracks can be erased following the unfinalize process, and new material can be recorded.

Finalizing

As has been explained earlier (see “Finalizing” on page 9), in order for a disc to become a standard CD, it must have a Table of Contents (TOC) written to it. This process is known as finalizing.

An unfinalized disc can always be distinguished on the CC-222MKIV by the NO TOC indicator under the disc type on the display being lit when the disc is inserted.

CAUTION

Do not turn the power off during this operation. Not only you may lose the recorded data, but also the disc may be damaged and become un-usable.

To finalize a disc:

- 1 With the unfinalized (recordable) disc loaded, and the unit in stop mode, press the FINALIZE key.

The display shows `Finalize OK ?`

- 2 To start the finalizing process, press the MULTI DIAL or press the ENTER key. If you do not want to proceed with the finalizing process, press the FINALIZE key or STOP key.

If finalization has been chosen, the display changes. The NO TOC indicator goes out, and the word TOC and the REC indicator flash in the display. The unit starts counting down from a time shown on the display.

After finalization, CD-RW, NO TOC indicator changes to CD-RW and CD-R, NO TOC changes to CD-R indicator.

NOTE

Although CD-R discs finalized on the CC-222MKIV may be replayed on ordinary CD players, remember that finalized CD-RW discs may not play on CD players.

Unfinalizing CD-RW discs

If a CD-RW disc has been finalized, it is possible to erase the Table of Contents in the following way:

- 1 With the finalized disc loaded and the unit in stop mode, press the ERASE key.
- 2 If the display does not show the word `Unfinalize?`, turn the MULTI DIAL or use the SKIP keys until it is displayed.
- 3 To start the unfinalizing process, press the MULTI DIAL control or press the ENTER key.

If you do not want to proceed with the unfinalizing process, press the ERASE key or STOP key.

If unfinalization has been chosen, the NO TOC indicator starts flashing in the display, and the word ERASE also starts flashing. The unit starts counting down from a time shown on the display.

After unfinalization, CD-RW indicator changes to CD-RW, NO TOC indicator.

Erasing

Unfinalizing (described above) is a special case of erasing a disc. It is also possible to erase a track or tracks, starting with the last-recorded track, a whole disc, or to “refresh” a disc.

NOTE

Erase procedures are possible only on a CD-RW disc. Even if a CD-RW disc has been finalized, selecting an erase procedure will automatically unfinalize it prior to erasure. The disc may then have to be re-finalized. Remember that it is not possible to perform any erase procedures on a CD-R disc.

6 – After recording

Erasing tracks

It is possible to erase the last recorded track, the last two recorded tracks, the last three recorded tracks, etc. It is not, however, possible to erase tracks in the “middle” of the disc.

CAUTION

This operation cannot be undone. If you are going to erase a track or tracks, make sure that they are recordings that you really want to erase!

NOTE

To operate this function, the unit should be in Continue mode. The function cannot be used when playback mode is Single, Random or Program. If erasing is attempted in such modes, Cannot ERASE! will be displayed.

- 1 With the disc loaded, and the unit in stop mode, press the ERASE key.
- 2 If the display does not show ERASE XX-XX?, where XX-XX is the number of the last track recorded on the disc, turn the MULTI DIAL or use the SKIP keys until it is displayed.
- 3 Turn the MULTI DIAL or use the SKIP keys to change the number of the first track to be erased. The highest value that this number can take is the last track recorded (for example, if 17 tracks have been

recorded on the disc, 17-17 means that the last track only, number 17, will be erased). The lowest value that this number can take is 2 (if this number was 1, the whole disc would be erased, as described below). If you do not want to proceed with the erase operation, press the ERASE key or STOP key.

NOTE

If only one track has been recorded on the disc, only the “erase disc” option (see “Erasing a whole disc” on page 29) is available.

- 4 When the range of tracks to be erased has been selected, press the MULTI DIAL or the ENTER key.

If the erase operation has been selected, the word ERASE flashes on the display, and the timer starts counting down.

At the end of the countdown period, the word Complete appears briefly on the display, and the display returns to the track/time display.

Erasing a whole disc

When you want to erase a whole disc (all the tracks on a disc), follow the procedure below:

- 1 With the disc loaded, and the unit in stop mode, press the ERASE key.
- 2 Turn the MULTI DIAL or use the SKIP keys until the display shows ERASE DISC?

If you do not want to proceed with the erase operation, press the ERASE key or STOP key.

- 3 To erase the contents of the disc, press the MULTI DIAL or the ENTER key.

NOTE

This operation cannot be undone. If you are going to erase a disc, make sure that it contains only recordings that you really want to erase!

If the erase operation has been selected, the word ERASE flashes on the display, and the timer starts counting down a time value shown on the display.

At the end of the countdown period, the word Complete appears briefly on the display, and the display returns to the track/time display.

Refreshing a disc

If a CD-RW disc has been corrupted at any point (e.g. power has been cut off in the middle of a finalize operation, etc.), or has been used in a computer or another piece of equipment that makes it unreadable, it is possible to “refresh” the disc to make it usable again.

- 1 With the disc loaded, and the unit in stop mode, press the ERASE key.
- 2 Turn the MULTI DIAL or use the SKIP keys until the display shows DISC REFRESH?
- 3 To refresh the disc, press the MULTI DIAL or the ENTER key.

If you do not want to proceed with the refresh operation, press the ERASE key or STOP key.

NOTE

This operation cannot be undone. If you are going to refresh a disc, make sure that it contains only recordings that you really want to erase!

If the refresh operation has been selected, the words ERASE XXX:XX are shown on the display, and the timer starts counting down.

At the end of the countdown period, the word Complete appears briefly on the display, and the display returns to the track/time display (of course, there are no tracks, and the disc is at the start, with the total time of the disc available for recording).

7 – Cassette operating

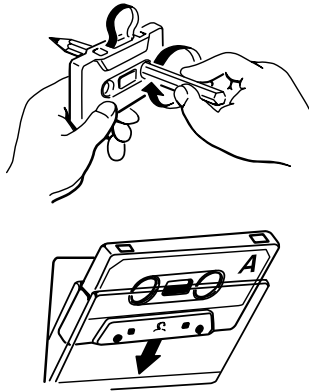

Note the following when loading tapes:

- 1 Use your finger or a pencil to turn the cassette's hub and take up any slack tape.

NOTE



Avoid touching the tape. Fingerprints attract dust and dirt.

Playback operations

WARNING

If you are monitoring using headphones, first adjust the level control to low on the unit, then connect to the PHONES jack before playing back. This will prevent any possible damage to your hearing.

- 1 Set the REV MODE switch to the required tape mode.

	Single-sided playback
	One side, then the other side, then stop
	One side, then the other side, then the first side again, etc.

Also, check the MONITOR switch is set to TAPE.

Continuous tape/CD playback

- 1 Load the tape as described above into the unit.
Load the disc recorded side downwards into the unit.
- 2 Press the CD-TAPE CONT PLAY key.
- 3 Press either of the PLAY keys of the tape deck or the CD deck.

Playback will start on the appropriate unit. When playback reaches the end of the disc, or the end of the tape as determined by the REV MODE setting, playback starts on the other unit.

NOTE

Media (tape or disc) can be changed in the unit that is not playing.

- 4 To stop playback and cancel the mode, press the CD-TAPE CONT PLAY key again.

- 2 Press the EJECT key to open the cassette compartment door.
- 3 Load the cassette tape with its open edge facing down.
- 4 Gently close the compartment door.

NOTE

The cassette holder cannot be opened during recording or playback.

If the power has been switched off during play or recording, ejecting the cassette may be impossible. In such a case, switch the power on and press the EJECT key again.

- 2 Load a pre-recorded cassette with its open edge facing down and side A facing toward you.
- 3 Press either PLAY key to start playback.
- 4 Adjust the volume with the amplifier's volume control.
- 5 To stop playback, press the STOP key.

NOTE

The cassette deck and CD deck can be used to play back through different outputs, or the LINE OUTPUTS 2 jacks can be used for both disc and tape playback (see "OUT2 setting (TAPE or AUTO)" on page 33 for details). However, note that if both are playing, the cassette takes priority (the disc will not be heard through these outputs).

The LINE OUTPUTS1 jacks always output the audio from the disc.

7 – Cassette operating

Recording operations

Recording pre-recorded tapes, records, or other published or broadcast material may infringe copyright laws. Check before recording.

- 1 Set the REV MODE switch.

If you want to make a bi-directional recording, set the REV MODE switch to the \curvearrowright or \curvearrowleft position.

Set to the \curvearrowright position if recording is to be made on a single side of the tape.

- 2 Load a recordable cassette. Check that the safety tabs on the spine of the cassette are in place. If they have been broken off, block the holes with adhesive tape.

- 3 Press the INPUT 2 SEL key to select either LINE2 or DISC as a recording source.

When DISC is selected, the built-in CD player's output is selected as a source.

When LINE2 is selected, the external signal from the LINE 2 jacks is selected as a source.

- 4 Press the RECORD key. The deck enters record standby mode and the indicators light up.
- 5 Play back the source, and adjust the recording level using the tape deck's INPUT level control so that the loudest sound makes the meters briefly reach around the "0 dB" point for normal or high-position tapes (recording is not possible with metal tapes).
- 6 Press either the PAUSE or PLAY key to start recording.
To stop recording temporarily, press the PAUSE key. To restart recording, press either the PAUSE key or PLAY keys. If the PLAY key whose indicator is unlit is pressed, the recording direction will reverse, and the PLAY key must be pressed again to restart recording.
- 7 To stop recording, press the STOP key.

Dubbing tapes from the CD deck

To record from the internal CD deck:

- 1 Prepare for recording as described above (load a tape, set the REV MODE, etc.).
- 2 Load the source CD disc into the unit with the recorded side down.
- 3 Use the MENU key to set the dubbing volume to THRU to bypass the input level control (see "Bypassing the input level for dubbing" on page 24).

If you want to adjust the input volume, set the DUB>VOL menu to ON and use the left (tape) INPUT control to adjust the level of signals fed to the tape from the CD player.

NOTE

If you want to record the tracks on the tape in a different order from those on the disc, use the programmed playback mode to rearrange the tracks (see "Program playback" on page 17). Leave the disc in stop mode when you have finished programming the order.

- 4 Press the DUB 2 key.

If the tape is in stop mode, the tape rewinds to the beginning of the current side.

At the start of the tape, recording starts, but the CD does not start playback for eight seconds. The DUB indicator flashes.

The CD starts playback after the eight seconds at the start of the cassette. The DUB, 2 indicator lights steadily.

If the tape is in record standby mode, recording

starts immediately, and the CD starts playback immediately. The DUB, 2 indicator lights.

The dubbing stops when playback reaches the end of the CD, or when the tape reaches the end of its run (one side in the case of single-sided (\curvearrowright) reverse mode, both sides in the \curvearrowright reverse mode), whichever comes first.

Note that if the tape is set to auto-reverse, and the last item recorded on one side of a tape was not completely recorded before the tape was reversed, that item will be automatically repeated.

Also note that when the tape automatically reverses, eight seconds are used as non-recorded time at the beginning of the second side (the tape is in record mode, but the CD does not play back), again to allow for leader tape at the start of the cassette.

The dubbing process can also be stopped manually with the STOP key of the cassette deck or the CD deck. All other transport keys are disabled.

NOTE

Dubbing is not possible if a cassette is not loaded, or a CD is not loaded. It is not possible if the cassette is write-protected, or if the CD is a recordable disc which does not currently have any material recorded on it.

It is also not possible to enter the dubbing mode if the tape is not in stop or record standby mode, or if the CD is not in stop or pause mode.

7 – Cassette operating

Dubbing to tape from the middle of a CD

The above procedure describes the playback and recording from the start of a disc (or the start of a programmed playback list).

To record from a point other than the ones above:

- 1 Locate the disc to the point where the playback is to start.
- 2 Press the disc PAUSE key to pause playback at the point where the playback is to start.

- 3 If recording is to start at the beginning of the cassette, make sure the cassette is stopped, otherwise, locate the cassette to the appropriate position where recording is to start, and enter record standby mode.

Using the headphones with the MONITOR switch set to MIX will help here.

- 4 Press the DUB 2 key. Playback starts on the disc, and recording starts on the cassette.

Recording tapes from the PHONO deck

To record from an external record deck connected through the RIAA PHONO inputs:

- 1 Prepare for recording as described above (load a tape, set the REV MODE, etc.).
- 2 Press the MENU key until the PHONO>XXX menu item is shown.

Turning the MULTI DIAL or pressing the SKIP keys on the remote control to select either TAPE.

Press the MULTI DIAL or ENTER on the remote control unit.

- 3 Press the PHONO key. The PHONO indicator lights on the display.

If the tape is currently in stop mode, the tape rewinds, and the deck enters record standby mode (about eight seconds from the start of the cassette, to allow for leader tape).

If the tape deck is already in record standby mode, it will remain in record standby mode.

- 4 Start playback of the record.

- 5 Start recording with either the PLAY or PAUSE key.

Press STOP (cassette deck) to stop the recording. The STOP key is the only key which is enabled during phono recording.

NOTE

It is not possible to perform phono recording as described above under the following circumstances: a tape is not loaded or the tape is write-protected (the phono to tape function is disabled with no recordable tape inserted), or the tape is not either stopped or in record standby mode.

Only recording as described above is possible from the RIAA PHONO sources to tape. Manual recording is not possible.

Other recording features

Recording silences between items

When recording, press and release either of the REC MUTE keys (main or remote). With the tape moving, the record source is muted for about four seconds (the display record indicator flashes), and the deck then enters record pause mode. Press PAUSE or PLAY to re-start recording.

If the REC MUTE key is pressed while the deck is in record standby mode, four seconds of silence will be recorded on the tape, and the deck will return to record standby mode.

If the REC MUTE key is held and pressed for longer than four seconds while recording is in progress, silence is

recorded on the tape while the key is held down. The deck enters record standby mode when the key is released.

Erasing tapes

Anything previously recorded on the tape will automatically be erased when you make a new recording on it. It can also be erased by “recording” on it with the INPUT level control set to “0”.

7 – Cassette operating

Other tape functions and features

Tape counter

The tape counter value increments when the tape is moving from left to right, and decrements when it moves from right to left.

Use either of the **RESET** keys (main or remote) to reset the value to 0000.

When the counter has been set to 0000, this position can be reached easily by pressing either of the **RTZ** keys (main or remote). The tape fast forwards or fast rewinds to the 0000 mark.

NOTE

If the current tape position is too close to the 0000 mark (greater than 9995 or less than 0004), this function is not available.

Pitch control

The tape speed can be controlled using the **PITCH CONTROL**.

Turning this to the right of the center position results in faster tape speed (higher pitch), and turning to the left of the center position results in slower tape speed (lower pitch). The maximum is 10% away from normal.

The center “neutral” position is marked by a click detent.

OUT2 setting (TAPE or AUTO)

Using the OUT2 menu, you can assign the **LINE OUTPUTS2** to **TAPE** or **AUTO** (the default setting is **TAPE**).

If **TAPE** is selected, the unit outputs only the cassette tape when playing back or monitoring.

If **AUTO** is selected, the unit outputs either the cassette tape or disc automatically when playing back or monitoring. However, note that if both are playing at same time, the cassette takes priority (the disc will not be heard through these outputs).

1. Press the **MENU** key until the menu item **OUT2>XXX** shows up on the display.
2. Turn the **MULTI DIAL** to select **TAPE** or **AUTO**.
3. Push the **MULTI DIAL** to confirm and exit the menu operation.

8 – Reference and specifications

Error messages

Message	Details / Response
Cannot Rec!	Use unfinalized recordable disc.
Disc Error!	If it is CD-RW disc, you may refresh it (“Refreshing a disc” on page 29), or replace disc.
Disc Full !!	There is no space on disc, or no tracks are available.
Drive Error!	There is problem with the Drive mechanism.
D-IN UNLOCK!	Digital input is not connected. Turn on power of source unit and connect to DIGITAL IN.
Cannot ERASE!	The data cannot be erased.
Erase Error!	An error has occurred while trying to erase disc.
Not Fs 44.1k!	The sampling frequency of digital input is not 44.1kHz. Please turn SRC on (“Frequency conversion” on page 21).
PGM Full !	An attempt has been made to create more than 99 tracks.
Rec Error	A general recording error. Try recording again with different disc.
System Err!	System Error. Try turning the power off and on again.
Tray Error!	There is a problem with the CD tray.

Messages displayed during normal operation

Message	Statement
Complete	An operation such as finalize or erase has been successfully completed.
Now OPC	Calibration is being performed to operate recording properly.
Now REPAIR	The disc is being repaired and this operation will take a long time. Please do not turn off power of the unit until it finishes.
PMA Writing	Recorded content is being written to disc.
TOC Reading	Table of contents data is being read.
REC Standby	The unit is in recording standby mode.
Blank Disc	A blank recordable disc has been inserted.
NO DISC	A disc is not loaded into the unit.

8 – Reference and specifications

Specifications

CD recorder section

Supported disc types	CD, CD-R, CD-R-DA, CD-RW, CD-RW-DA (High speed CD-RW is supported)
Playback disc formats	CD-DA, CD-ROM ISO9660 LEVEL1/2Joliet format and multisession discs
Playback file formats	CD-DA: 44.1kHz, 16-bit stereo MP3: 44.1kHz, 64–320kbps, VBR
Recording file formats	CD-DA: 44.1kHz, 16-bit stereo
Frequency response	20 Hz – 20 KHz ±0.8 dB (playback) ±1.0 dB (recording)
S/N ratio	92 dB (playback) 88 dB (recording)
Dynamic range	92 dB (playback) 88 dB (recording)
Total harmonic distortion	0.006% (playback) 0.01% (recording)
Channel separation	80 dB (playback: 1kHz) 75 dB (recording: 1kHz)
Wow and flutter	unmeasurable (< 0.001 %)
Digital input Fs	32 kHz to 48 kHz (SRC ON) 44.1 kHz (SRC OFF)
Digital input	Coaxial RCA pin jack (IEC60958-3) Digital Optical jack (IEC60958-3)
Digital output	Coaxial RCA pin jack (IEC60958-3) Digital Optical jack (IEC60958-3)
Line inputs 1	Unbalanced input RCA pin Level -10 dBV (Full Scale -16 dB) Maximum input level +6 dBV Input impedance 50 k Ω ±10 % (unbalanced)
Line outputs 1	Unbalanced output RCA pin Level -10 dBV (Full Scale -16 dB) Maximum output level +6 dBV ±2 dB Output impedance 600 Ω ±10% (unbalanced)

Cassette recorder section

Number of channels	4-track, 2-channel stereo
Heads	Record/playback x 1 (rotary reverse), erase x 1
Type of tapes	C-46 - C-90 type cassette tapes (metal tapes can only be played back)
Tape speed	4.76 cm/s (1 7/8 ips)
Motor	DC servo motor x 1
Wow and flutter	<0.25% (W.RMS)
Frequency response (overall)	30 Hz – 15 kHz ±4 dB (high position) 30 Hz – 13 kHz ±4 dB (normal)
Signal-to-noise ratio (overall)	53 dB(Maximum input level)
Fast winding time	About 160 seconds (C-60)
Line inputs 2	Unbalanced RCA Normal input level 0.28 V (-11 dBV) Input impedance 50 k Ω
Line outputs 2	Unbalanced RCA Normal output level 0.46 V (-6.7 dBV) Output impedance 1k Ω

8 – Reference and specifications

Phono input and headphones

RIAA PHONO INPUT	Unblanced RCA (with ground)
	Cartridge type MM (moving magnet)
	Input signal level 5.6 mV
	Input impedance 50 k Ω
	S/N ratio 60 dB (6.3 Ω)
PHONES (headphone output)	6 mm (1/4") stereo
	Output level 10 mW + 10 mW (into 32 Ω)

General specifications

Power	U.S.A./Canada 120 VAC, 60 Hz
	U.K./Erope 230 VAC, 50 Hz
	Australia 240 VAC, 50 Hz
Power consumption	35 W
Dimensions (d x w x h)	295 x 483 x 138 (mm)
	11.6 x 19.0 x 5.4 (in)
Weight	7.2 kg (15.9 lb)

8 – Reference and specifications

Dimensional drawing

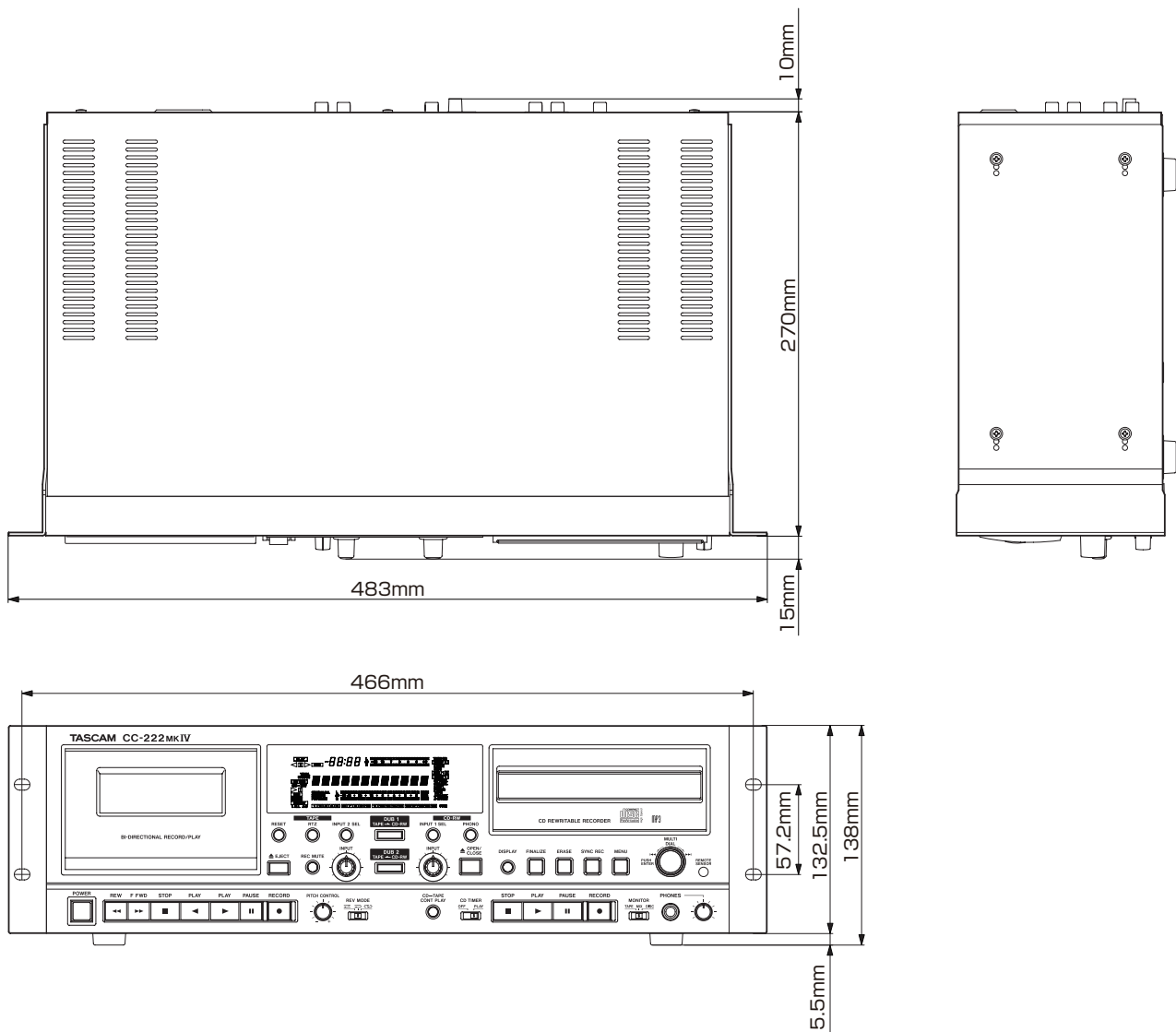

- Illustrations and other depictions may differ in part from the actual product.
- Specifications and external appearance may be changed without notification to improve the product.

WARRANTY

< In the United States >

This warranty gives you specific legal rights and you may also have other rights which vary from state to state. This warranty is only valid within the country the unit was originally purchased.

WHAT IS AND IS NOT COVERED

Except as specified below, this warranty covers all defects in materials and workmanship in this product. The following are not covered by the warranty:

1. **Damage to or deterioration of the external cabinet.**
2. **Damages resulting from accident, misuse, abuse or neglect.**
3. **Damage resulting from failure to perform basic daily maintenance and/or calibration or otherwise resulting from failure to follow instructions contained in your owner's manual.**
4. **Damage occurring during shipment of the product. (Claims must be presented to the carrier)**
5. **Damage resulting from repair or attempted repair by anyone other than TEAC or an authorized TASCAM service station.**
6. **Damage resulting from causes other than product defects, including lack of technical skill, competence, or experience of the user.**
7. **Damage to any unit which has been altered or on which the serial number has been defaced, modified or is missing.**

WHO MAY ENFORCE THE WARRANTY

This warranty may be enforced only by the original purchaser.

LENGTH OF WARRANTY

All parts except heads and disk drives are warranted for one (1) year from the date of original purchase. Heads and disk drives are warranted to ninety (90) days from date of original purchase. Labor is warranted for ninety (90) days from date of original purchase.

WHAT WE WILL PAY FOR

We will pay all labor and material expenses for items covered by the warranty. Payment of shipping charges is discussed in the next section of this warranty.

HOW YOU CAN GET WARRANTY SERVICE

Your unit must be serviced by an authorized TASCAM service station in the United States. (This warranty is not enforceable outside the U.S.) If you are unable to locate an authorized TASCAM service station in your area, please contact us. We either will refer you to an authorized service station or instruct you to return the unit to the factory. Whenever warranty service is required, you must present a copy of the original dated sales receipt from an Authorized TASCAM Dealer.

You must pay any shipping charges if it is necessary to ship the product to service. However, if the necessary repairs are covered by the warranty, we will pay return surface shipping charges to any destination within the United States.

LIMITATION OF IMPLIED WARRANTIES

Any implied warranties, INCLUDING WARRANTIES OF MERCHANTABILITY AND FITNESS FOR A PARTICULAR PURPOSE, are limited in duration to the length of this warranty.

EXCLUSION OF DAMAGES

TEAC's liability for any defective product is limited to repair or replacement of the product, at TEAC's option. TEAC shall not be liable for:

1. **Damages based upon inconvenience, loss of use of the product, loss of time interrupted operation or commercial loss; or**
2. **Any other damages, whether incidental, consequential or otherwise.**

Some states do not allow limitations on how long an implied warranty lasts and/or do not allow the exclusion or limitation of incidental or consequential damages, so the above limitations and exclusions may not apply to you.

To locate an Authorized Service Center in Your Area

CALL 1-800-447-8322

< Europe >

This product is subject to the legal warranty regulations of the country of purchase. In case of a defect or a problem, please contact the dealer where you bought the product.

Ce produit est sujet aux réglementations concernant la garantie légale dans le pays d'achat. En cas de défaut ou de problème, veuillez contacter le revendeur chez qui vous avez acheté le produit.

Dieses Gerät unterliegt den gesetzlichen Gewährleistungsbestimmungen des Landes, in dem es erworben wurde. Bitte wenden Sie sich im Gewährleistungsfall an den Händler, bei dem sie das Gerät erworben haben.

Questo apparecchio è conforme alle norme sulla garanzia vigenti nel rispettivo Paese in cui esso è stato acquistato. Si prega di rivolgersi al proprio commerciante, presso il quale è stato acquistato l'apparecchio, nel caso in cui si voglia richiedere una prestazione in garanzia.

Las condiciones de garantía de este aparato están sujetas a las disposiciones legales sobre garantía del país en el que ha sido adquirido. En caso de garantía, debe dirigirse al establecimiento donde adquirió el aparato.

< In other countries/areas >

This warranty gives you specific legal rights, and you may also have other rights that vary by country, state or province.

If you have a warranty claim or request, please contact the dealer where you bought the product.

该保证书赋予了顾客特定的合法权利，并且因国家、州或省等地域的不同，顾客可能拥有其他权利。如需申请或要求保修，请与购买本产品的销售店进行联系。

If you require repair services for your TASCAM equipment, please contact the dealer where the product was purchased from or the TASCAM Distributor in your country. A list of TASCAM Distributors can be found on our website at: <http://teac-global.com/>

TASCAM

TEAC CORPORATION

Phone: +81-42-356-9143

1-47 Ochiai, Tama-shi, Tokyo 206-8530 Japan

<http://tascam.jp/>

TEAC AMERICA, INC.

Phone: +1-323-726-0303

7733 Telegraph Road, Montebello, California 90640 USA

<http://tascam.com/>

TEAC MEXICO, S.A. de C.V.

Phone: +52-55-5010-6000

Río Churubusco 364, Colonia Del Carmen, Delegación Coyoacán, CP 04100, México DF, México

<http://teacmexico.net/>

TEAC UK LIMITED

Phone: +44-8451-302511

Meridien House, Ground Floor, 69 - 71, Clarendon Road, Watford, Hertfordshire, WD17 1DS, UK

<http://tascam.eu/>

TEAC EUROPE GmbH

Phone: +49-611-71580

Bahnstrasse 12, 65205 Wiesbaden-Erbenheim, Germany

<http://tascam.eu/>

TEAC SALES & TRADING(SHENZHEN) CO., LTD

Phone: +86-755-88311561~2

Room 817, Block A, Hailrun Complex, 6021 Shennan Blvd., Futian District, Shenzhen 518040, China

Printed in China

WARRANTY

Model/Modèle/Modell
Model/Modèle/Modell

Sample
CC-222 MKIV

Owner's name/Nom du possesseur/Name des Eigentimers
Nome del proprietario/Nombre del propietario/ 顾客姓名

Serial No./No. de Série/Seriennummer
Numero di serie/Número de serie/ 序列号

Address/Adresse/Adresse
Indirizzo/Dirección/ 顾客地址

Date of purchase/Date de l'achat/Datum des Kaufs
Data dell'acquisto/Fecha de compra/ 购买日期

Dealer's name/Nom du détaillant/Name des Händlers
Nome del commerciante/Nombre del establecimiento/ 销售店名

TASCAM

<http://teac-global.com/>

Dealer's address/Adresse du détaillant/Adresse des Händlers
Indirizzo del commerciante/Dirección del establecimiento/ 销售店地址