

TASCAM

D01231820A

CD-A550mkII

Compact Disc Player / Reverse Cassette Deck

OWNER'S MANUAL

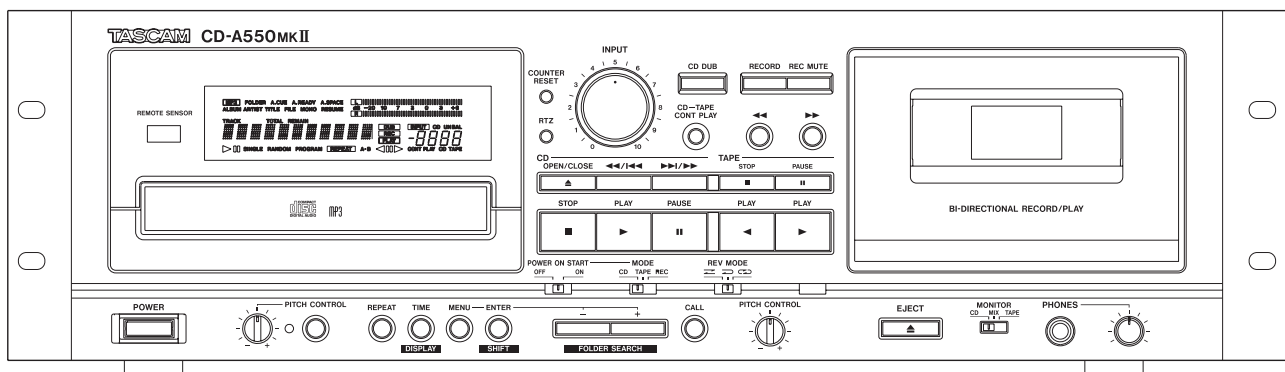

IMPORTANT SAFETY PRECAUTIONS



CAUTION
RISK OF ELECTRIC SHOCK
DO NOT OPEN



CAUTION: TO REDUCE THE RISK OF ELECTRIC SHOCK, DO NOT REMOVE COVER (OR BACK). NO USER-SERVICEABLE PARTS INSIDE. REFER SERVICING TO QUALIFIED SERVICE PERSONNEL.



The lightning flash with arrowhead symbol, within equilateral triangle, is intended to alert the user to the presence of uninsulated "dangerous voltage" within the product's enclosure that may be of sufficient magnitude to constitute a risk of electric shock to persons.



The exclamation point within an equilateral triangle is intended to alert the user to the presence of important operating and maintenance (servicing) instructions in the literature accompanying the appliance.

For U.S.A.

TO THE USER

This equipment has been tested and found to comply with the limits for a Class A digital device, pursuant to Part 15 of the FCC Rules. These limits are designed to provide reasonable protection against harmful interference when the equipment is operated in a commercial environment. This equipment generates, uses, and can radiate radio frequency energy and, if not installed and used in accordance with the instruction manual, may cause harmful interference to radio communications.

Operation of this equipment in a residential area is likely to cause harmful interference in which case the user will be required to correct the interference at his own expense.

CAUTION

Changes or modifications to this equipment not expressly approved by TEAC CORPORATION for compliance could void the user's authority to operate this equipment.

**WARNING: TO PREVENT FIRE OR SHOCK
HAZARD, DO NOT EXPOSE THIS
APPLIANCE TO RAIN OR MOISTURE.**

In North America use only on 120V supply.

IMPORTANT SAFETY INSTRUCTIONS

- 1 Read these instructions.
- 2 Keep these instructions.
- 3 Heed all warnings.
- 4 Follow all instructions.
- 5 Do not use this apparatus near water.
- 6 Clean only with dry cloth.
- 7 Do not block any ventilation openings. Install in accordance with the manufacturer's instructions.
- 8 Do not install near any heat sources such as radiators, heat registers, stoves, or other apparatus (including amplifiers) that produce heat.
- 9 Do not defeat the safety purpose of the polarized or grounding-type plug. A polarized plug has two blades with one wider than the other. A grounding type plug has two blades and a third grounding prong. The wide blade or the third prong are provided for your safety. If the provided plug does not fit into your outlet, consult an electrician for replacement of the obsolete outlet.
- 10 Protect the power cord from being walked on or pinched particularly at plugs, convenience receptacles, and the point where they exit from the apparatus.
- 11 Only use attachments/accessories specified by the manufacturer.
- 12 Use only with the cart, stand, tripod, bracket, or table specified by the manufacturer, or sold with the apparatus. When a cart is used, use caution when moving the cart/apparatus combination to avoid injury from tip-over.



- 13 Unplug this apparatus during lightning storms or when unused for long periods of time.
- 14 Refer all servicing to qualified service personnel. Servicing is required when the apparatus has been damaged in any way, such as power-supply cord or plug is damaged, liquid has been spilled or objects have fallen into the apparatus, the apparatus has been exposed to rain or moisture, does not operate normally, or has been dropped.

- The apparatus draws nominal non-operating power from the AC outlet with its POWER or STANDBY/ON switch not in the ON position.
- The mains plug is used as the disconnect device, the disconnect device shall remain readily operable.
- Caution should be taken when using earphones or headphones with the product because excessive sound pressure (volume) from earphones or headphones can cause hearing loss.
- If you are experiencing problems with this product, contact TEAC for a service referral. Do not use the product until it has been repaired.

CAUTION

- Do not expose this apparatus to drips or splashes.
- Do not place any objects filled with liquids, such as vases, on the apparatus.
- Do not install this apparatus in a confined space such as a book case or similar unit.
- The apparatus should be located close enough to the AC outlet so that you can easily grasp the power cord plug at any time.
- If the product uses batteries (including a battery pack or installed batteries), they should not be exposed to sunshine, fire or excessive heat.
- CAUTION for products that use replaceable lithium batteries: there is danger of explosion if a battery is replaced with an incorrect type of battery. Replace only with the same or equivalent type.

WARNING

- Products with Class I construction are equipped with a power supply cord that has a grounding plug. The cord of such a product must be plugged into an AC outlet that has a protective grounding connection.

■ RACK-MOUNTING THE UNIT

Use the supplied rack-mounting kit to mount the unit in a standard 19-inch rack, as shown below.

Remove the feet of the unit before mounting.

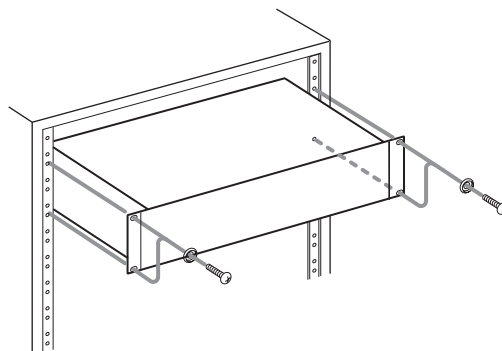

CAUTION

- Leave 1U of space above the unit for ventilation.
- Allow at least 10 cm (4 in) at the rear of the unit for ventilation.

IMPORTANT SAFETY PRECAUTIONS

■ CAUTIONS ABOUT BATTERIES

This product uses batteries. Misuse of batteries could cause a leak, rupture or other trouble. Always abide by the following precautions when using batteries.

- Never recharge non-rechargeable batteries. The batteries could rupture or leak, causing fire or injury.
- When installing batteries, pay attention to the polarity indications (plus/minus (+/-) orientation), and install them correctly in the battery compartment as indicated. Putting them in backward could make the batteries rupture or leak, causing fire, injury or stains around them.
- When you store or dispose batteries, isolate their terminals with insulation tape or something like that to prevent them from contacting other batteries or metallic objects.
- When throwing used batteries away, follow the disposal instructions indicated on the batteries and the local disposal laws.
- Do not use batteries other than those specified. Do not mix and use new and old batteries or different types of batteries together. The batteries could rupture or leak, causing fire, injury or stains around them.
- Do not carry or store batteries together with small metal objects. The batteries could short, causing leak, rupture or other trouble.
- Do not heat or disassemble batteries. Do not put them in fire or water. Batteries could rupture or leak, causing fire, injury or stains around them.
- If the battery fluid leaks, wipe away any fluid on the battery case before inserting new batteries. If the battery fluid gets in an eye, it could cause loss of eyesight. If fluid does enter an eye, wash it out thoroughly with clean water without rubbing the eye and then consult a doctor immediately. If the fluid gets on a person's body or clothing, it could cause skin injuries or burns. If this should happen, wash it off with clean water and then consult a doctor immediately.
- The unit power should be off when you install and replace batteries.
- Remove the batteries if you do not plan to use the unit for a long time. Batteries could rupture or leak, causing fire, injury or stains around them. If the battery fluid leaks, wipe away any fluid on the battery compartment before inserting new batteries.
- Do not disassemble a battery. The acid inside the battery could harm skin or clothing.

This product has been designed and manufactured according to FDA regulations "title 21, CFR, chapter 1, subchapter J, based on the Radiation Control for Health and Safety Act of 1968", and is classified as a class 1 laser product. There is no hazardous invisible laser radiation during operation because invisible laser radiation emitted inside of this product is completely confined in the protective housings.

The label required in this regulation is shown at ①.

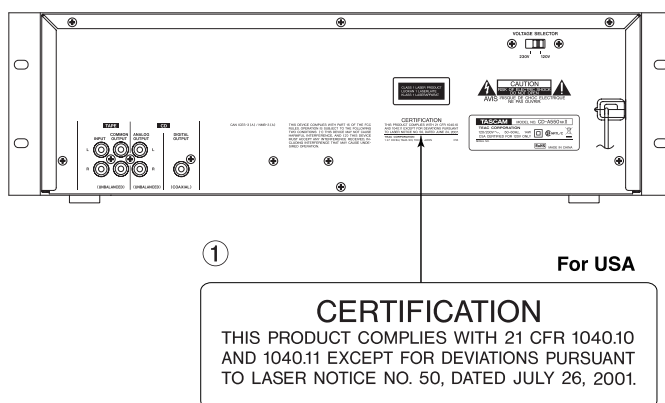

CAUTION:

- DO NOT REMOVE THE PROTECTIVE HOUSING USING A SCREWDRIVER.
- USE OF CONTROLS OR ADJUSTMENTS OR PERFORMANCE OF PROCEDURES OTHER THAN THOSE SPECIFIED HEREIN MAY RESULT IN HAZARDOUS RADIATION EXPOSURE.
- IF THIS PRODUCT DEVELOPS TROUBLE, CONTACT YOUR NEAREST QUALIFIED SERVICE PERSONNEL, AND DO NOT USE THE PRODUCT IN ITS DAMAGED STATE.

Optical pickup

Type	: EP-C101
Manufacturer	: GUANGDONG EVER BRIGHT GROUP CO.,LTD.
Laser output	: Less than 0.3mW on the objective lens
Wavelength	: 790±25nm

1 – Introduction	7	Folder playback (data CDs only)	24
Main Features	7	Setting the folder playback mode with the remote control	24
Items included with this product.....	7	Setting the folder playback mode from the main unit	24
About this manual	7	Playback modes	25
About trademarks	8	Selecting the playback mode	25
Precautions for placement	8	Programmed playback	26
Beware of condensation	8	Setting the program	26
Cleaning the unit	8	Clearing the entire program	27
Cleaning the cassette recorder head section	8	Checking the program.....	27
About compact discs (CDs)	8	Editing the program	27
Precautions for CD use	8	Playback time display mode	27
About cassette tapes.....	9	Text information display mode	28
Precautions for cassette use	9	Repeat playback	28
Using the TEAC Global Site	9	Ordinary repeat playback	28
User registration	9	A–B repeat playback	29
2 – Names and Functions of Parts	10	Pitch control	29
Front panel.....	10	Auto cue function (audio CDs only)	29
Rear panel	12	Turning auto cue ON and OFF using the remote control A.CUE key.....	30
Wireless remote control (RC-A550)	13	Auto ready function	30
Display	14	Turning the auto ready function ON and OFF from the main unit	30
3 – Menu	16	Auto space function	31
Menu structure	16	Turning the auto space function ON and OFF from the main unit	31
Using the menu	16	Incremental play	31
4 – Preparations	18	Call function	32
Making connections	18	Resume playback	32
Setting the common output signal	19	EOM function	32
Preparing the remote control.....	19	6 – Playing Back Cassette Tapes	33
Installing the batteries	19	Preparation for tape playback	33
When to change the batteries	19	Selecting the reverse mode	33
Precautions for the use of batteries	19	Playing a tape	33
Considerations for the use of the remote control	20	Tape counter	34
Adjust the display brightness (DIMMER)	20	RTZ.....	35
5 – Playing Back CDs	21	Pitch control	35
Discs that can be played	21	7 – Recording Cassette Tapes	36
Data CD folders and tracks	21	Preparing to record	36
Loading a CD.....	21	Selecting the reverse mode.....	36
Tray lock function	22	Selecting the recording source	36
CD playback	22	Recording	37
Selecting a track	23	Recording mute function	37
Skipping to the next or previous track ..	23	Dubbing a CD to a tape.....	37
Selecting by track number	23	Basic dubbing (recording to the A side of a tape from its beginning)	38
Selecting a folder (data CDs only)	23	Adjusting the record level when dubbing.....	38
Search forward and backward	24		

Contents

Using the TAPE EDIT function	39
Recording from the middle of a tape	39
8 – Other Functions.....	40
Continuous playback of both the CD and the tape	40
Power-on start	41
Restoring default settings.....	41
Mono playback	42
Viewing information about this unit	42
Checking versions	42
Checking the motor operation time.....	42
10 – Message list.....	43
Operation messages	43
Warning messages	43
Error messages	44
11 – Troubleshooting	45
12 – Specifications.....	46
Ratings.....	46
CD player	46
Cassette tape	46
Analog audio	46
CD player section	46
Cassette tape section	46
Headphones section	47
Digital audio	47
CD player section	47
General	47
Dimensional drawing.....	47

Thank you very much for purchasing a TASCAM CD-A550MKII Compact Disc Player/Reverse Cassette Deck. Before using your unit, please read this manual carefully so that you will understand the correct operating procedures and be able to use all its functions fully. We hope that you will enjoy using this product for many years to come.

Please keep this manual for future reference. You can also download a digital copy from the TEAC Global Site (<http://teac-global.com/>).

Main Features

- CD player and cassette recorder can be operated completely independently
- Includes CD-only output jacks and common output jacks that can output the tape signal, the mixed CD and tape signals or prioritize the tape signal
- Continuous CD and cassette tape playback possible
- When dubbing from a CD to a cassette tape, automatic division of tracks to the tape A and B sides is possible (TAPE EDIT function)
- CD or cassette tape power-on playback and cassette tape power-on record are possible
- Monitoring with headphones possible
- Wireless remote control with numerical keys included
- 3U rack-mount size

CD functions

- CD-R and CD-RW disc playback possible
- CD text display possible
- MP3 and WAV file playback possible
- Resume playback function allows playback to be continued from the last played position
- Auto cue function finds the position of the first sound in a track (audio CDs only)
- Auto ready function can pause playback at the beginning of the next track after playing a track
- When playback is stopped in the middle of a track, the incremental play function automatically pauses at the beginning of the next track
- Auto space function can automatically create space between playback tracks
- Call (back cue) function can return to the playback starting point
- EOM function gives advance notice before a track ends
- Four playback modes (continuous, single, random, program)
- Repeat playback function

- Pitch control function ($\pm 12.5\%$)
- Tray opening prevention during playback

Cassette tape functions

- Auto reverse recording and playback possible
- RTZ (return-to-zero) function
- Playback pitch control function ($\pm 10\%$)

Items included with this product

The following items are included with this product. Unpack the unit carefully to avoid damaging it. Please save the box and packaging materials for transportation of the unit in the future. If any of the accessories are missing or appear to have been damaged during transportation, please contact TASCAM.

- Main unit 1
- Wireless remote control (RC-A550) 1
- AA batteries 2
- Screw kit for rack-mounting 1
- Owner's Manual (this document)..... 1

The warranty is included at the end of this manual.

About this manual

The following conventions are used in this manual.

- Keys, jacks and other parts on this unit and external devices are indicated with a bold typeface like this:
MENU
- When the alphanumeric portion of the display shows a message, this is shown in the following typeface:
RANDOM
- If a preset indicator in the display (i.e. one which cannot change) is shown, this is shown as follows: **REMAIN**
- The state when the main display area shows times and titles is called the "standard display."
- Discs in CD-DA format are sometimes called "audio CDs."
- CDs with MP3 and WAV audio files on them are sometimes called "data CDs."
- Additional information is presented as necessary in sections with "TIP," "NOTE" and "CAUTION" labels.

TIP

Tips suggest ways that the unit can be used.

NOTE

Notes provide additional explanation and describe special cases, for example.

CAUTION

Cautions are instructions that must be followed to avoid

1 – Introduction

possible injury, equipment malfunction or damage to CDs or cassette tapes.

About trademarks

- TASCAM is a trademark of TEAC Corporation, registered in the U.S. and other countries.
- MPEG Layer-3 audio coding technology is licensed from Fraunhofer IIS and Thomson.
- Other company names, product names and logos in this document are the trademarks or registered trademarks of their respective owners.

Precautions for placement

- The guaranteed operating temperature of this unit is between 5° and 40° C.
- Install the unit in a level position.
- To improve dissipation of heat, do not place other items on top of this unit.
- Do not place this unit on top of a powered amplifier or other equipment that generates much heat.

Beware of condensation

Condensation could occur if the unit is moved from a cold place to a warm place, used in a room that has just been heated or subject to other sudden temperature change. To prevent this, let the unit sit for one or two hours before turning the power on in such situations.

Cleaning the unit

To clean the unit, wipe it gently with a soft dry cloth. Do not use chemical cleaning cloths, benzene, paint thinner, alcohol or other chemical agents to clean the unit as they could damage the surface or cause fading.

Cleaning the cassette recorder head section

If the cassette recorder head becomes dirty, the quality of playback and recording could be degraded and the sound could even be interrupted.

Moreover, if the tape transport becomes dirty, the tape could become entangled, for example. Clean the cassette recorder's head, pinch roller and capstan using a cotton swab moistened with a commercially available cleaning fluid after about every 10 hours of use.

CAUTION

Do not play or record a tape until the cleaning fluid has dried.

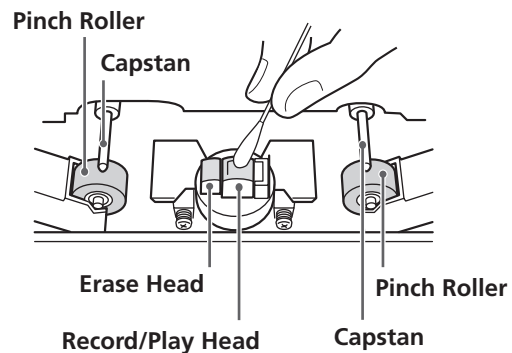

About compact discs (CDs)

In addition to commercially-available music CDs, this unit can play CD-R and CD-RW discs that have been recorded in audio CD (CD-DA) format, as well as CD-R and CD-RW discs that have MP3 audio and WAV audio files recorded on them. This unit can also play 8-cm CDs.

Precautions for CD use

- Always place compact discs in the tray with their labels facing upward.
- To remove a disc from its case, press down on the center of the disc holder and lift the disc out by its outer edge.
- Do not touch the signal side (the unlabeled side). Fingerprints, oils and other substances can cause errors during playback.
- If there are fingerprints or dust on the signal side, use a soft cloth to wipe it gently from the center outwards. Dirt on discs can lower the sound quality, so clean them and always store them in a clean state.
- Never use record cleaner, antistatic solutions, benzene, thinner or other chemical substances to clean a disc. Doing so could damage the surface and make the CD unplayable.
- Do not apply labels or other materials to discs. Do not use discs that have had tape, stickers or other materials applied to their surface. Do not use discs that have sticky residue from stickers, etc. Such discs could become stuck in the unit or cause it to malfunction.
- Never use commercially available CD stabilizers. Their use could make disc playback impossible or cause the unit to malfunction.
- Do not use cracked discs.
- Do not use specially shaped discs, including heart-shaped, business card-shaped or octagonal discs. Using such discs could damage the unit.

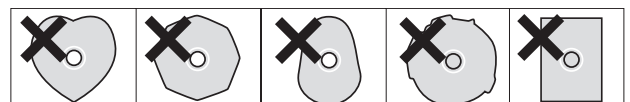

- With the intention of protecting copyrights, several record companies sell discs with a “copy control CD” designation. Some of these discs do not comply with CD specifications and might not be playable in this unit.

About cassette tapes

Usable types of tapes

Recordable tapes: Type I (normal)

Type II (high position)

Playable tapes: Type I (normal)

Type II (high position)

Type IV (metal)

Write-protection tabs for preventing unintentional recording

Cassettes have write-protection tabs to prevent the unintentional erasure of recordings. There are tabs for cassette sides A (1) and B (2). Use the tip of a screwdriver or similar tool to remove these tabs to prevent future recording. Put adhesive tape over the hole to allow recording again.

Tape slack

Before using a cassette confirm that the tape is not slack. Slack tape could become entangled in the capstan or other parts. Use a pencil or the like to wind the tape until it is no longer slack.

Automatic tape type detection holes

Cassettes have automatic tape detection holes that allow this unit to automatically determine the type of tape inserted.

Types of cassette tapes that are not recommended for use with this unit

Use of the following types of cassette tapes might prevent normal operation or performance. Moreover, use of these types of tapes should be avoided because they could become entangled in the unit and result in unexpected malfunction.

- Irregular cassette tapes

Cassettes that are deformed, have irregular tape movement or that make unusual noises during fast-forwarding and rewinding should not be used.

- Long-play tapes

Tapes that are longer than 90 minutes are very thin and easily stretched, which can result in warbling or flutter. Moreover, these tapes can become entangled in the equipment, so their use should be avoided.

Precautions for cassette use

- Do not open cassettes or pull out their tape.

- Do not touch the side of the tape that has the magnetic coating with bare hands.
- Do not leave them in places with lots of garbage or dust.
- Do not use or store them in hot or humid places.
- Avoid using or storing them in places with strong magnetic fields. Doing so could cause noise or the erasure of recorded contents.

Using the TEAC Global Site

You can download the Owner’s Manual necessary for this unit from the TEAC Global Site (<http://teac-global.com/>).

- 1 Open the TEAC Global Site (<http://teac-global.com/>).
- 2 In the TASCAM Downloads section, click the desired language to open the Downloads website page for that language.

NOTE

If the desired language does not appear, click Other Languages.

- 3 Click the product name in the “Search by Model Name” section to open the Downloads page for that product.
- 4 Select and download the Owner’s Manual that are needed.

User registration

Customers in the USA, please visit the TASCAM website (<http://tascam.com/>) to register as a user online.

2 – Names and Functions of Parts

Front panel

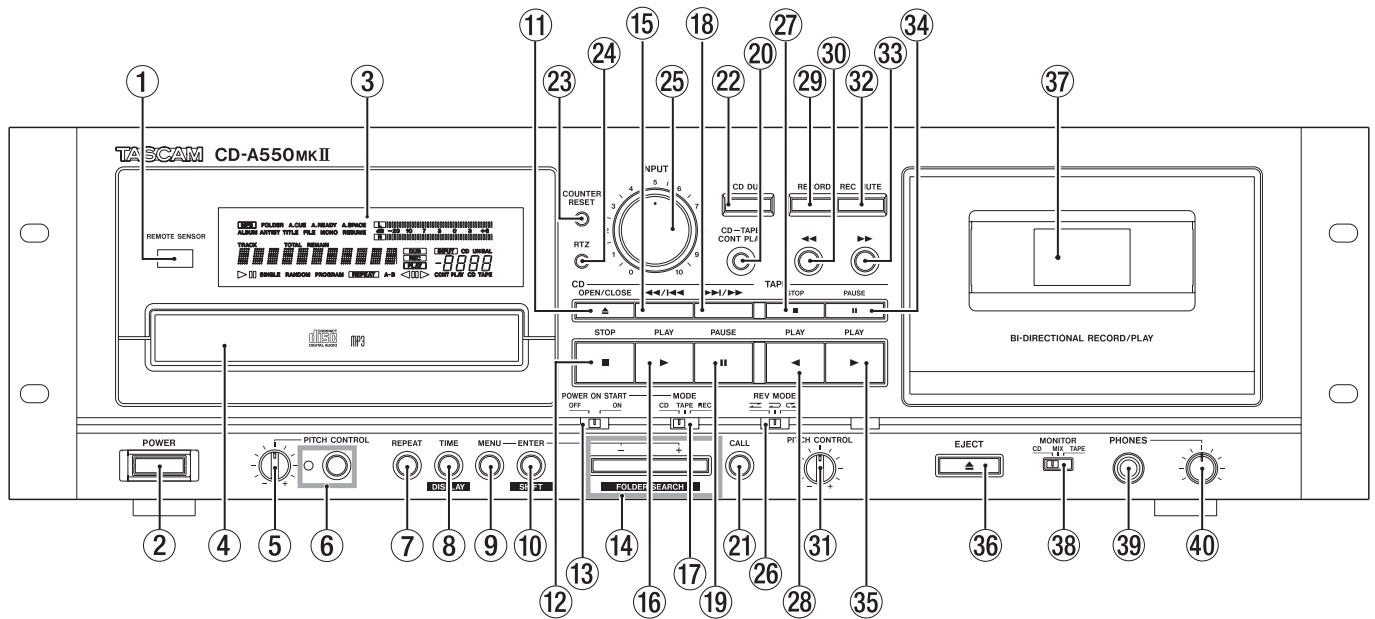

- ① Remote sensor
Signals from the included wireless remote control (RC-A550) are received here. When using the remote control, point it towards this sensor.
- ② POWER button
Use to turn the unit's power ON and OFF.
- ③ Display
Shows the transport status, currently selected input source, record and playback signal levels, menus, etc.

CD section

- ④ Disc tray
Press the OPEN/CLOSE key to open the disc tray and insert and remove discs. Press the OPEN/CLOSE key again to close the disc tray.
- ⑤ PITCH CONTROL knob
Use to adjust the playback pitch of a CD. (See "Pitch control" on page 29.)
- ⑥ PITCH CONTROL key/indicator
Use this key to turn the CD pitch control function ON and OFF. (See "Pitch control" on page 29.)
The indicator lights when ON.
- ⑦ REPEAT key
Press to turn the repeat playback function ON and OFF. (See "Repeat playback" on page 28.)
- ⑧ TIME/DISPLAY key
When the playback time is displayed, press this key to cycle the playback time display mode through track elapsed time, track remaining time and total remaining time. When text information is displayed, press this key to switch to playback time display. (See "Playback time display mode" on page 27.)

When the playback time is displayed, press this key while holding down the SHIFT key to switch to text information display, which includes album name, song name, artist name and file name.

During text information display, press this key while holding down the SHIFT key to switch between text information contents (album name, song name, artist name and file name).

Press and hold this key during text information display to scroll through the display items. (See "Text information display mode" on page 28.)

- ⑨ MENU key
When in standard display mode, press this key to switch to menu mode, which allows menu items to be selected. When in menu item selection mode, press this to return to the standard display mode. When editing a menu item, press this key to return to menu item selection display. (See "3 – Menu" on page 16.)
- ⑩ ENTER/SHIFT key
When in menu mode, press this to make a selection or confirm a setting. When not in menu mode, this functions as the SHIFT key.
- ⑪ OPEN/CLOSE key
Press to open and close the disc tray.
- ⑫ STOP key
Press to stop CD playback.
- ⑬ POWER ON START switch
Turn the power-on start function ON and OFF. (See "Power-on start" on page 41.)

2 – Names and Functions of Parts

- ⑭ **-/+/ FOLDER SEARCH** keys
When in menu mode, use these to make selections and settings.
When a data CD is loaded, use these keys while holding down the SHIFT key to change the current folder. (See “Folder playback (data CDs only)” on page 24.)
- ⑮ **◀◀/|◀◀** key
Press briefly to skip to the previous track.
Press and hold to search backwards.
- ⑯ **PLAY** key
When stopped or paused, press to start CD playback.
- ⑰ **MODE** switch
Set the power-on start mode to CD playback, cassette tape playback or cassette tape record. (See “Power-on start” on page 41.)
- ⑱ **▶▶/|▶▶** key
Press briefly to skip to the next track.
Press and hold to search forwards.
- ⑲ **READY** key
Press to pause CD playback.
- ⑳ **CD-TAPE CONT PLAY** key
Press to turn the cassette tape and CD continuous playback mode ON and OFF. (See “Continuous playback of both the CD and the tape” on page 40.)
- ㉑ **CALL** key
Press to pause playback and return to the point where playback was last started from a paused state. (See “Call function” on page 32.)
- ㉒ **CD DUB** key
Press to record (dub) the CD playback sound to a cassette tape. (See “Dubbing a CD to a tape” on page 37.)

Cassette tape section

- ㉓ **COUNTER RESET** key
Press to reset the tape counter to “0000.”
- ㉔ **RTZ** key
Press to return the cassette tape playback position to the counter zero point (0000).
- ㉕ **INPUT** knob
Adjusts the cassette tape record level. (See “Recording” on page 37.)
- ㉖ **REV MODE** switch
Use to set the tape playback mode to one-way (↔), both directions (↔) or continuous (↻). (See “Selecting the reverse mode” on page 33.)
When recording, the unit records only once in both directions even if set to continuous (↻). (See “Selecting the reverse mode” on page 36.)
- ㉗ **STOP** key
Press to stop the cassette tape.

- ㉘ **PLAY [◀]** key
Press to play a cassette tape in the reverse direction.
When the unit is record ready or playback is paused, recording or playback starts.
However, if you press this key when playback is paused in the forward direction, playback is paused in the reverse direction.
- ㉙ **RECORD** key
Puts the cassette tape into record ready status.
- ㉚ **◀◀** key
Press to rewind the cassette tape.
- ㉛ **PITCH CONTROL** knob
Use to adjust the cassette tape playback pitch (±10%). (See “Pitch control” on page 29.)
- ㉜ **REC MUTE** key
Press during recording to put the unit into record ready status after recording about four seconds of silence. (See “Recording mute function” on page 37.)
- ㉝ **▶▶** key
Press to fast-forward the cassette tape.
- ㉞ **PAUSE** key
Press to pause cassette tape playback or recording.
When the unit is record ready or playback is paused, press to start recording or playback.
- ㉟ **PLAY [▶]** key
Press to play a cassette tape in the forward direction.
Use to start recording or playback when in record ready mode or when playback is paused.
However, if you press this key when playback is paused in the reverse direction, the playback is paused in the forward direction.
- ㊱ **EJECT** button
Press to open the cassette compartment.
- ㊲ **Cassette compartment**
Press the EJECT button to open the cassette compartment so that cassette tapes can be removed or loaded. To close the cassette compartment, press its door directly with your hand.

Monitoring section

- ㊳ **MONITOR** switch
Set the sound output from the PHONES jack to either the CD sound only, the tape sound only, or a mix of the CD and tape sounds.
- ㊴ **PHONES** jack
Connect stereo headphones (standard stereo phone jack).
- ㊵ **PHONES** knob
Use to adjust the volume of the sound output from the PHONES jack.

2 – Names and Functions of Parts

Rear panel

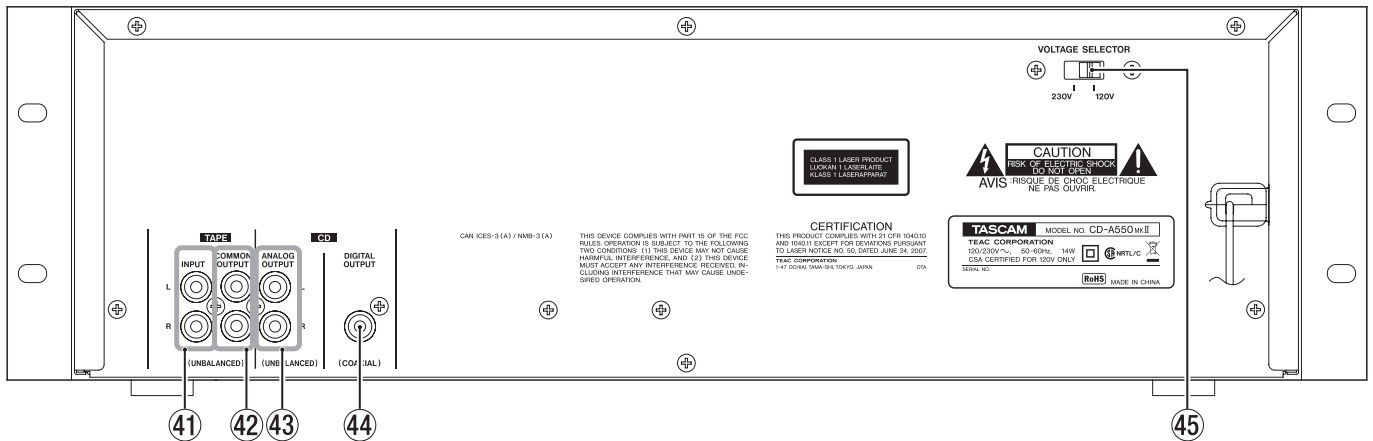

- ④1 **TAPE INPUT (UNBALANCED) jacks**
Input for analog source signals (–9 dBu, unbalanced) to record to the cassette tape.
- ④2 **TAPE COMMON OUTPUT (UNBALANCED) jacks**
These are unbalanced outputs (–4.5 dBu) for the cassette tape playback signal. During recording or when in record ready mode, the signal being recorded is output. However, depending on the setting of the COMMON OUT item in the menu, the CD playback signal can be output instead. (See “Setting the common output signal” on page 19.)
- ④3 **CD OUTPUT (UNBALANCED) jacks**
These are unbalanced outputs (–10 dBV) for the CD playback signal.
- ④4 **CD DIGITAL OUTPUT (COAXIAL) jack**
This digital output sends the CD playback signal in S/PDIF format.
- ④5 **VOLTAGE SELECTOR SW**
Use this switch to set the input voltage to either 230V or 120V.

NOTE

- The voltage selector is only available on units for specific markets.
- In North America, use only on 120V supply.

2 – Names and Functions of Parts

Wireless remote control (RC-A550)

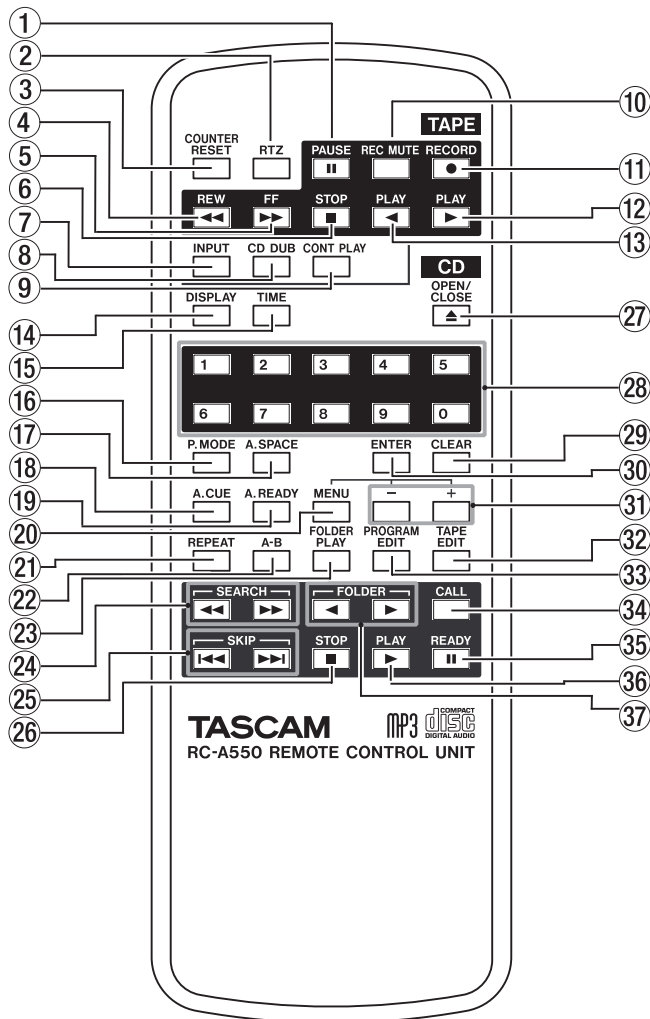

Cassette tape section

- ① PAUSE key
Press to pause playback and recording.
When the unit is record ready or playback is paused, press to start recording or playback.
- ② RTZ key
Press to return the cassette tape playback position to the counter zero point (0000).
- ③ COUNTER RESET key
Press to reset the tape counter to “0000.” (See “Tape counter” on page 34.)
- ④ REW key
Press to rewind the cassette tape.
- ⑤ FF key
Press to fast-forward the cassette tape.
- ⑥ STOP key
Press to stop the cassette tape.
- ⑦ INPUT key
Press to select the source to be recorded on the cassette tape. (See “Selecting the recording source” on page 36.)

- ⑧ CD DUB key
Press to record (dub) the CD playback sound to a cassette tape. (See “Dubbing a CD to a tape” on page 37.)
- ⑨ CONT PLAY key
Press to turn the cassette tape and CD continuous playback mode ON and OFF. (See “Continuous playback of both the CD and the tape” on page 40.)
- ⑩ REC MUTE key
Press during recording to put the unit into record ready status after recording about four seconds of silence. (See “Recording mute function” on page 37.)
- ⑪ RECORD key
Puts the cassette tape into record ready status.
- ⑫ PLAY [▶] key
Press to play a cassette tape in the forward direction.
Press to start recording or playback when in record ready mode or when playback is paused.
However, if you press this key when playback is paused in the reverse direction, playback is paused in the forward direction.
- ⑬ PLAY [◀] key
Press to play a cassette tape in the reverse direction.
When the unit is record ready or playback is paused, recording or playback starts.
However, if you press this key when playback is paused in the forward direction, playback is paused in the reverse direction.

CD Section

- ⑭ DISPLAY key
When the playback time is displayed, press this key to switch to text information display, which includes album name, song name, artist name and file name.
When text information is displayed, press this key to cycle through the text information shown, including album name, song name, artist name and file name.
Press and hold this key during text information display to scroll through the display items. (See “Text information display mode” on page 28.)
- ⑮ TIME key
When the playback time is displayed, press this key to change the playback time display mode (track elapsed time, track remaining time, and total remaining time). When text information is displayed, press this key to switch to playback time display. (See “Playback time display mode” on page 27.)
- ⑯ P.MODE key
Press this to switch between the four playback modes, including continuous playback, single playback, random playback and program playback. (See “Playback modes” on page 25.)

2 – Names and Functions of Parts

- ⑰ **A.SPACE key**
Press to turn the auto space function ON and OFF. (See “Auto space function” on page 31.)
- ⑱ **A.CUE key**
Press to turn the auto cue function ON and OFF. (See “Auto cue function (audio CDs only)” on page 29.)
- ⑲ **A.READY key**
Press to turn the auto ready function ON and OFF. (See “Auto ready function” on page 30.)
- ⑳ **MENU key**
When in standard display mode, press this key to switch to the menu mode, which allows menu items to be selected. When in menu item selection mode, press this to return to the standard display mode. When editing a menu item, press this key to return to menu item selection display. (See “3 – Menu” on page 16.)
- ㉑ **REPEAT key**
Press to turn the repeat playback function ON and OFF. (See “Repeat playback” on page 28.)
- ㉒ **A–B key**
Press this to set and unset the start point and end point for A–B repeat playback. (See “A–B repeat playback” on page 29.)
- ㉓ **FOLDER PLAY key**
Press to turn the folder playback function ON and OFF. (See “Folder playback (data CDs only)” on page 24.)
- ㉔ **SEARCH ◀◀/▶▶ keys**
Press and hold these keys to search backwards or forwards.
- ㉕ **SKIP ◀◀/▶▶ keys**
Press these to skip to the previous or next track.
- ㉖ **STOP key**
Press to stop CD playback.
- ㉗ **OPEN/CLOSE key**
Press to open and close the disc tray.
- ㉘ **Numerical keys**
Use these to designate track numbers during CD playback and program input.
- ㉙ **CLEAR key**
Press this to remove a track from the program when editing the program. (See “Programmed playback” on page 26.)
- ㉚ **ENTER key**
When in menu mode, press this to make a selection or confirm a setting.
- ㉛ **–/+ keys**
When in menu mode, use these to make selections and settings.
- ㉜ **TAPE EDIT key**
Press to execute the TAPE EDIT function. (See “Using the TAPE EDIT function” on page 39.)
- ㉝ **PROGRAM EDIT key**
Press to enter program editing mode. (See “Programmed playback” on page 26.)
Press during program editing mode to exit program editing mode and return to the standard display.
- ㉞ **CALL key**
Press to pause playback and return to the point where playback was last started from a paused state. (See “Call function” on page 32.)
- ㉟ **READY key**
Press to pause CD playback.
- ㊱ **PLAY key**
When stopped or paused, press to start CD playback.
- ㊲ **FOLDER ◀/▶ key**
Press to switch the folder on a data CD.

Display

This unit shows the following information on the display.

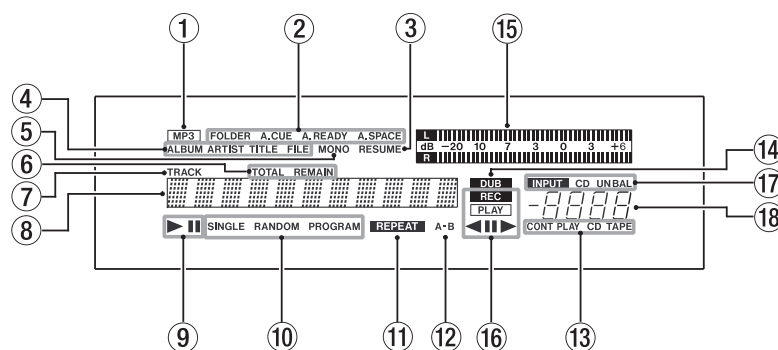

CD Section

- ① **MP3 indicator**
This indicator appears when a data CD with MP3 or WAV files is loaded in the unit.
- ② **CD function display**
The FOLDER, A.CUE, A.READY and A.SPACE indicators appear when the CD folder playback function, auto ready function, auto cue function and auto space function are ON, respectively.

2 – Names and Functions of Parts

- ③ **RESUME indicator**
This appears when the CD resume playback function is ON.
- ④ **Text information mode display indicators**
When disc text information is being shown, **ALBUM**, **ARTIST**, **TITLE** and **FILE** indicators appear according to the contents.
- ⑤ **MONO indicator**
This indicator appears when output is set to mono.
- ⑥ **Playback time display mode display**
When the playback time is being displayed, these indicators show the current time display mode.
 - **TOTAL REMAIN** appears when the playback time display mode is total remaining time.
 - **REMAIN** appears when the playback time display mode is track remaining time.
 - No indicator appears when the playback time display mode is track elapsed time. No indicator appears when the main display is showing text information (menu, title display, etc.) or when in menu mode or program setting mode.
- ⑦ **TRACK indicator**
This appears when the main display is showing the time display. It blinks during incremental play operation. This indicator does not appear when the main display is showing text information (menu, title, etc.) or is in menu mode or program setting mode.
- ⑧ **Main display**
This display area has 11 characters. In addition to showing CD track, playback time and title information, this area shows information when in menu mode and various status messages (errors, etc.).
- ⑨ **CD transport status indicators**
When a CD is playing, the ► indicator appears. When a CD is paused the || indicator appears.
- ⑩ **Playback mode indicators**
Indicators appear according to the CD playback mode. None of the indicators appear during ordinary playback (continuous playback) mode. During single mode, random mode and program mode, **SINGLE**, **RANDOM** and **PROGRAM** appear, respectively.
- ⑪ **REPEAT indicator**
This appears when the CD repeat playback function is ON.
- ⑫ **A–B indicator**
This appears when CD A–B repeat playback is on. When only the A point is set A– light and B blinks.
- ⑬ **CONT PLAY CD TAPE indicator**
This appears when continuous playback mode is operative. **CONT PLAY** blinks before starting operation (when CD and tape are stopped). **CD** blinks during CD playback. **TAPE** blinks during cassette tape playback.

- ⑭ **DUB indicator**
This appears during CD dubbing.

Cassette section

- ⑮ **Level meters**
These show the cassette tape playback and recording sound levels.
- ⑯ **Tape transport status indicators**
PLAY appears when the cassette tape is playing or paused. **REC** and **PLAY** both appear when recording or record ready. **REC** blinks when recording mute is functioning. **||** appears when playback is paused or the unit is record ready. The current transport direction (► or ◄) is also shown at all times.
- ⑰ **Cassette input source indicators**
The cassette tape input source is shown as **CD** for the CD, **UNBAL** for the unbalanced input.
- ⑱ **Tape counter**
This shows the cassette tape counter value. The counter value increases when moving forward. After “9999” the counter returns to “0000.” The counter value decreases when moving in reverse direction. After “0000” the counter reverts to “9999.”

3 – Menu

This unit uses a menu system to make various settings and use certain functions.

Menu structure

This unit's menu system includes the following menu items.

Menu No.	Item	Function
1	PLAY MODE	Playback mode selection
2	AUTO CUE	Set auto cue function
3	AUTO READY	Turn auto ready function ON and OFF
4	AUTO SPACE	Turn auto space function ON and OFF
5	FOLDER PLAY	Turn folder playback function ON and OFF
6	INCREMENTAL PLAY	Turn incremental play function ON and OFF
7	RESUME PLAY	Turn resume playback ON and OFF
8	PROGRAM EDIT	Edit the program
9	TAPE EDIT	Use the TAPE EDIT function
10	TRAY LOCK	Turn tray lock function ON and OFF
11	EOM DISPLAY	Set EOM display function
12	TAPE INPUT SOURCE	Select input source
13	COMMON OUT	Select COMMON OUTPUT source
14	MONO OUT	Turn mono output function ON and OFF
15	DUBBING LEVEL	Set record level during CD dubbing (fixed/volume)
16	FL DIMMER	Set the display brightness
17	VERSION	Show version information
18	MOTOR TIME	Show motor operation time
19	DEFAULT	Restore the unit to its default settings

Using the menu

Follow the basic procedures below to use the menu system to make settings. However, to use the PROGRAM EDIT and TAPE EDIT items, which are more complicated, see “Programmed playback” on page 26 and “Using the TAPE EDIT function” on page 39.

Moreover, selecting the VERSION and MOTOR TIME items causes information to be shown on the main display, but there are no settings to be made.

- 1 When in standard display mode, press the MENU key on the main unit or the remote control.

This puts the unit in menu mode, and the main display shows menu item selections. The menu item that was last selected the previous time that the menu was used is shown.

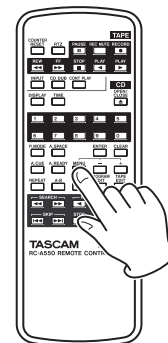
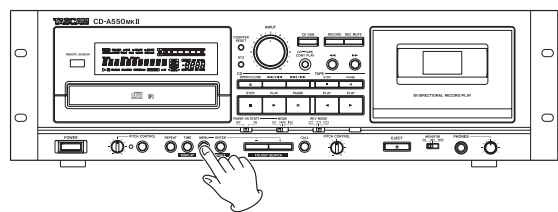

NOTE

Press the MENU key when the menu item selection is shown to return to the standard display.

- Use the $-/+$ keys on the main unit or the remote control to select the desired menu item.

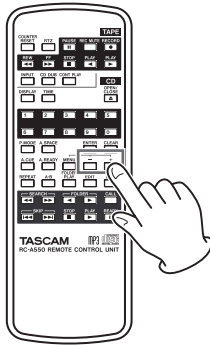
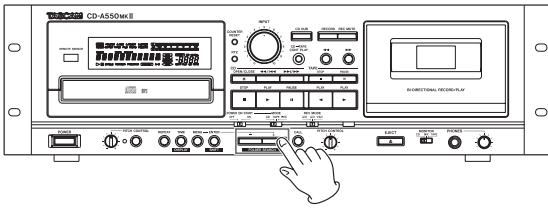

- Press the ENTER key on the main unit or the remote control to confirm the selection.

The menu item name and currently set value are shown. Use the following steps to change the settings.

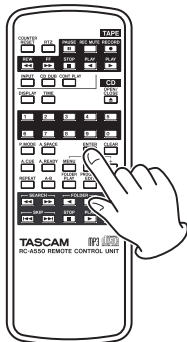
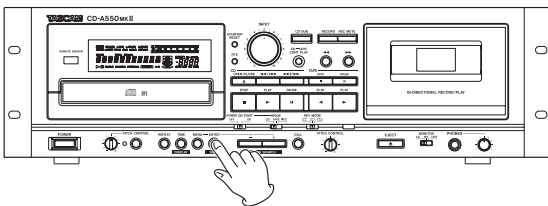

P. MODE > CONT

- Use the $-/+$ keys on the main unit or the remote control to select the desired value.

The selection takes effect immediately.

- Press the ENTER key on the main unit or the remote control to return to the standard display.

NOTE

If you press the MENU key while menu item names and setting values are displayed, the display returns to menu item selection.

4 – Preparations

Making connections

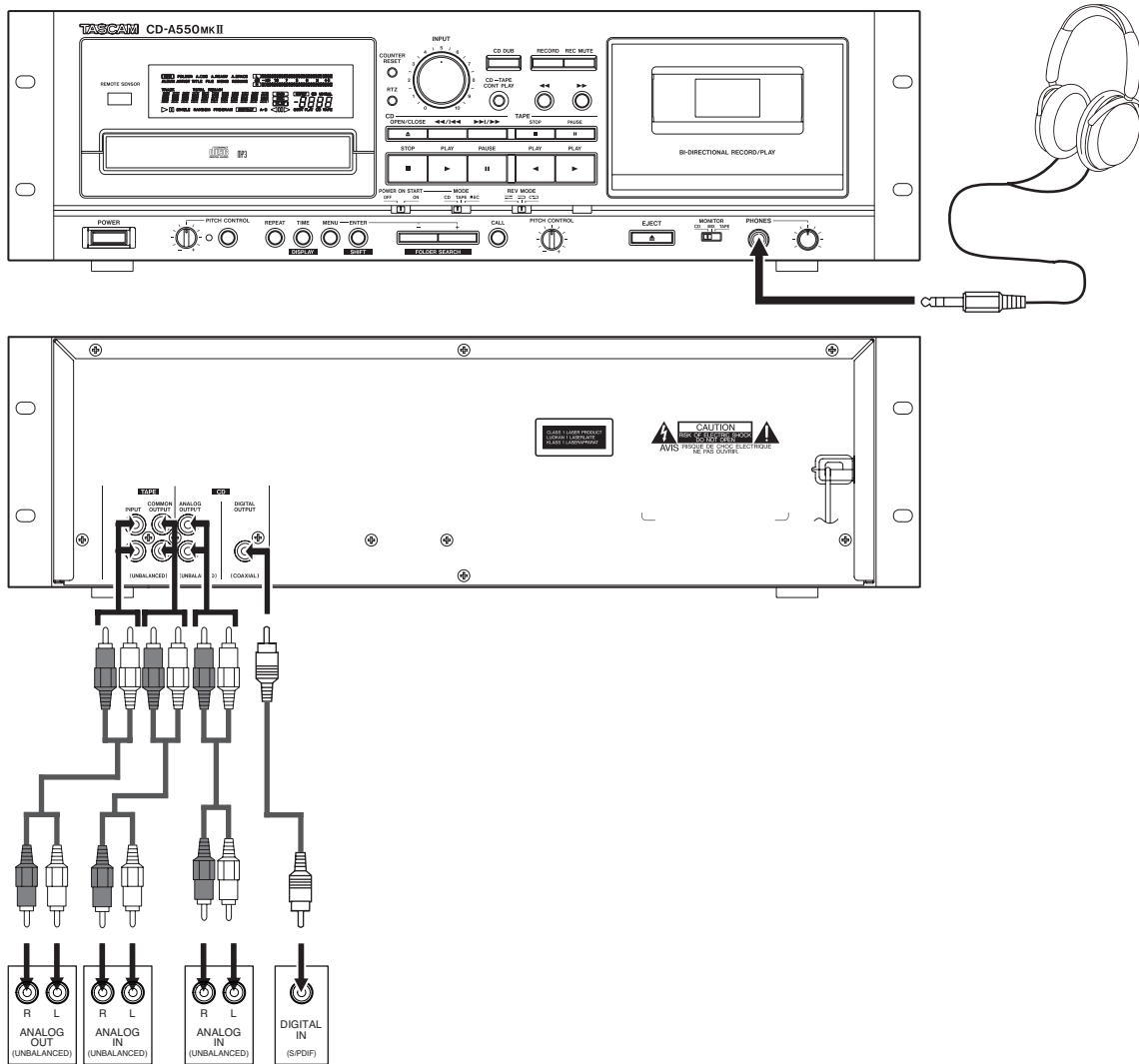

Connecting headphones

Connect stereo headphones to the PHONES jack on the front panel. Use the PHONES knob to the right of the PHONES jack to adjust the volume.

Use the MONITOR switch to the left of the PHONES jack to select the sound that is output through the PHONES jack. Choose either CD sound only (CD position), tape sound only (TAPE position) or a mix of the CD and tape sounds (MIX position).

Connecting external audio devices (input)

Connect external audio sources, including CD players and mixers, to this unit's TAPE INPUT (UNBALANCED) jacks. Use the TAPE INPUT SOURCE menu item to select the input. Use the INPUT knob on the front panel to adjust the input volume.

Connecting external audio devices (output)

For analog output, this unit has TAPE COMMON OUTPUT and CD ANALOG OUTPUT jacks.

In addition, the CD playback signal can be output digitally from the CD DIGITAL OUTPUT jack in S/PDIF format.

The CD OUTPUT jacks (ANALOG and DIGITAL) always output the CD playback signal. The TAPE COMMON OUTPUT jacks output the signal selected using the COMMON OUT menu item. (See "Setting the common output signal" on page 19.)

Setting the common output signal

Set the signal output from the TAPE COMMON OUTPUT jacks according to your operating needs for this unit.

- 1 When in standard display mode, press the MENU key on the main unit or the remote control to enter menu mode.
- 2 Use the $-/+$ keys on the main unit or the remote control to show the COMMON OUT? item on the main display, and press the ENTER key on the main unit or the remote control.

COMMON OUT?

- 3 Use the $-/+$ keys on the main unit or the remote control to select one of the following choices.

TAPE: This always outputs the tape playback signal.

AUTO (default value): outputs either the CD or the tape playback signal. When both are playing at the same time, only the tape signal is output.

MIX: Outputs both the CD and tape playback signals, mixing them when they are playing simultaneously.

- 4 Press the ENTER key to return to the standard display.

TIP

- If you want to output the CD and tape signals to different devices (or different channels of a mixer, for example), set the COMMON OUT item to "TAPE." By doing so, the CD signal will be output from the CD OUTPUT jacks, while the tape signal will be output from the TAPE COMMON OUTPUT jacks.
- If you're outputting the signal of this unit to one external device, such as an amplifier, set the COMMON OUT item to "AUTO" or "MIX." By doing so, this unit outputs the signal of the CD and/or the tape depending on their playback status.

Preparing the remote control

Installing the batteries

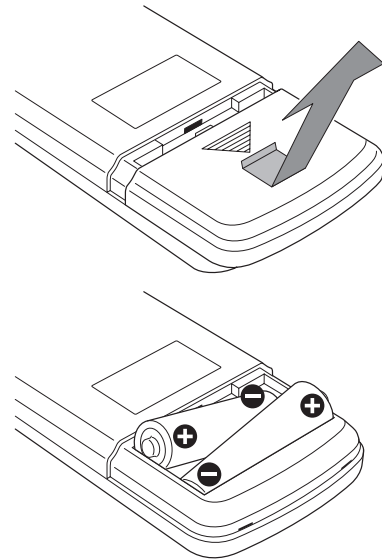

- 1 Open the cover on the back.
- 2 Insert two AA batteries, paying careful attention to their $+/-$ orientation.
- 3 Close the cover.

When to change the batteries

If the remote control operating distance becomes short or functions do not respond when their keys are pressed, replace both batteries with new ones at the same time.

Precautions for the use of batteries

Misuse of batteries can cause them to leak or rupture, for example. Please read the battery caution indications and page 4 of this manual carefully.

4 – Preparations

Considerations for the use of the remote control

- When using other devices that are controlled by infrared signals, operation of this unit's remote control could cause those devices to function improperly.
- Operate the remote control within the following range.

Remote sensor

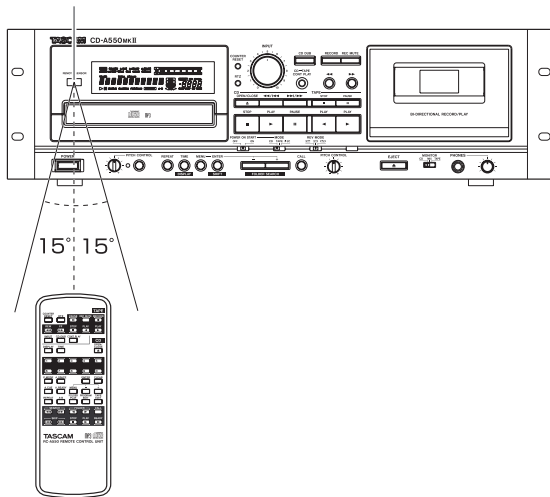

Operation distance

Front: 7 meters or less

Within a 15° angle: 7 meters or less

Adjust the display brightness (DIMMER)

You can adjust the display brightness to suit the operating environment of the unit.

- 1 When in standard display mode, press the MENU key on the main unit or the remote control to enter menu mode.
- 2 Use the $-/+$ keys on the main unit or the remote control to show the FL DIMMER? item on the main display, and press the ENTER key on the main unit or the remote control.

FL DIMMER?

- 3 Use the $-/+$ keys on the main unit or the remote control to select a value between 1 and 10.

The higher the number the brighter the display becomes. (The default value is 7.)

- 4 Press the ENTER key to return to the standard display.

5 – Playing Back CDs

This chapter explains the playback functions of this unit's CD player.

Discs that can be played

This unit's CD player can play the following types of discs.

- **CD-DA (audio CD) format discs**

This unit can play commercially available audio CDs and CD-R and CD-RW discs that have been recorded in audio CD format. These discs are called “audio CDs” in this manual.

- **CD-ROM (data CD) format discs**

This unit can play discs that contain MP3 and WAV files. These discs are called “data CDs” in this manual.

NOTE

MP3 files that can be played include files that have sampling frequencies of 32, 44.1 or 48 kHz, and bit rates of 32 to 320 kbps or variable bit rate (VBR). WAV files that can be played include files that have sampling frequencies of 8 to 48 kHz and are 8-bit or 16-bit.

CAUTION

MP3 files that use VBR compression

Due to format limitations, positions in VBR files cannot be accurately detected. For this reason, when using the call function, the A-B repeat function or other functions that require points to be set in the middle of tracks, the points set and the actual playback starting points might be slightly different.

Data CD folders and tracks

This unit treats all the audio files (WAV and MP3) on data CDs as “tracks.” Some data CDs store files inside folders in the same way that ordinary computers do. In addition, multiple folders can be stored inside another folder creating a multilevel structure.

This unit assigns a folder number to each folder to manage them. Folder numbers are assigned sequentially starting with the first folder at the highest level followed by the folders (subfolders) inside it. Folders inside a higher-level folder are numbered in order before the next folder in the higher-level is numbered as shown in the illustration below. If the root folder of a data CD contains one or more audio files, it will be numbered as the first folder.

Each audio file is also assigned a track number. Track numbers are assigned in order starting from those in the lowest numbered folder. During ordinary playback of data CDs, tracks are played back in the order of their assigned numbers just like the tracks on an audio CD. Folders that do not directly contain audio files are not

given numbers. For example, in the illustration below the folder that contains folder 5 is not given a number.

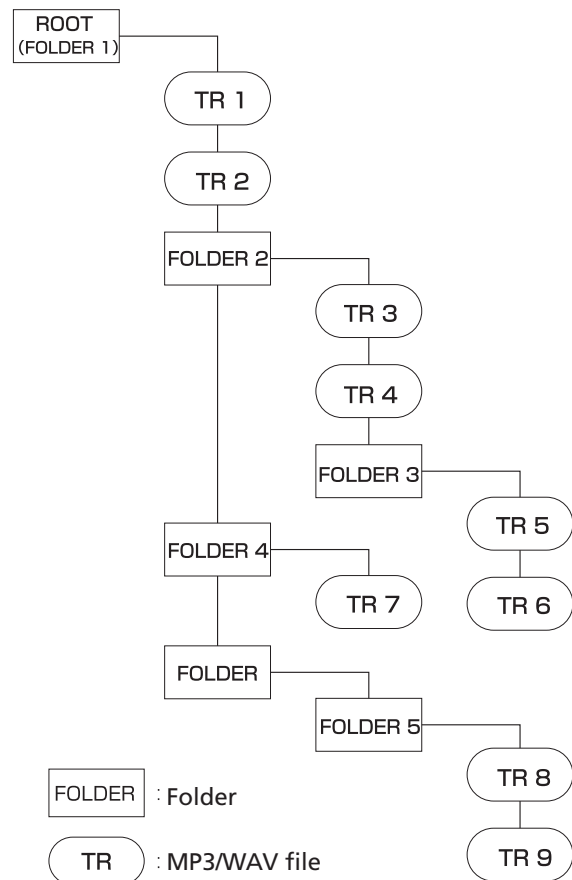

An Example of Data CD Structure

Loading a CD

To load a CD, press the OPEN/CLOSE key on the main unit or the remote control to open the disc tray and place a disc on it with the label side up.

Press the OPEN/CLOSE key again to close the disc tray. After a disc is loaded, this unit reads the disc information and shows on the display the total number of tracks and total playback time for an audio CD or the total number of tracks in the current folder or on the entire disc for a data CD.

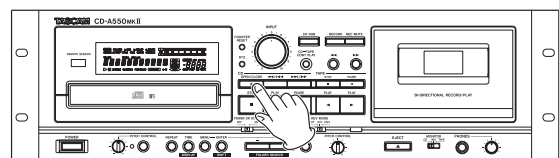

5 – Playing Back CDs

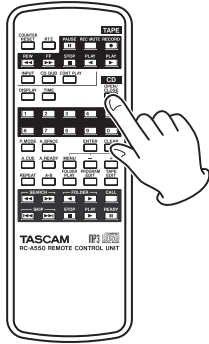

NOTE

Instead of pressing the OPEN/CLOSE key to close the disc tray, you can press the CD PLAY or READY key on the main unit or the remote control to close the disc tray and begin playback immediately.

CAUTION

If you open the disc tray while this unit is in use, the following settings are lost.

- Program
- CALL point
- Resume point
- Current folder (for data CDs)

Tray lock function

Turn the tray lock function ON to disable the OPEN/CLOSE keys during playback and when playback is paused so that the disc tray is not opened unintentionally. This allows you to prevent accidentally interrupting playback by pressing the OPEN/CLOSE key. The default setting for the unit is OFF. To turn the tray lock function ON, use the menu and conduct the following procedures.

- 1 When in standard display mode, press the MENU key on the main unit or the remote control to enter menu mode.
- 2 Use the $-/+$ keys on the main unit or the remote control to show “TRAY LOCK?” on the main display, and press the ENTER key.



TRAY LOCK?

- 3 Use the $-/+$ key to change the setting from OFF (default value) to ON.
- 4 Press the ENTER key to return to the standard display.

CD playback

The following explanation assumes that the necessary

connections have been made, the unit's power is ON and a CD (audio CD or data CD) has been loaded.

To start CD playback, press the CD PLAY key on the main unit or the remote control.

TIP

A CD and a cassette tape can be played at the same time.

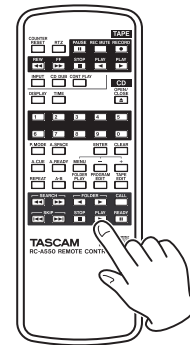
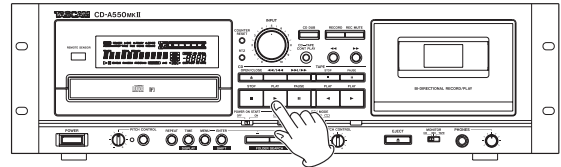

• Stopping playback

Press the CD STOP key on the main unit or the remote control.

• Pausing Playback

Press the READY key on the main unit or the remote control.

NOTE

In this Owner's Manual, explanations assume that the CD playback mode is set to CONTINUE (continuous playback mode) unless otherwise specified.

5 – Playing Back CDs

Selecting a track

There are two ways to select a track. You can move (skip) to the previous or next track, or you can select a track directly by its track number. In addition, you can skip to the next or previous folder of a data CD.

Skipping to the next or previous track

Press the ◀◀/▶▶ or ▶▶/▶▶ key on the main unit or the SKIP ◀◀/▶▶ key on the remote control. In addition, if you press and hold a SKIP ◀◀/▶▶ key on the remote control, the unit skips through multiple tracks successively.

NOTE

- If you skip to a track during playback, the selected track begins playing immediately.
- If you skip to a track while playback is paused or stopped, playback pauses at the beginning of the selected track.

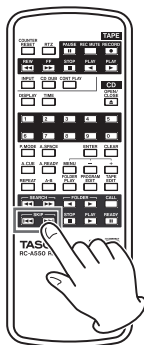
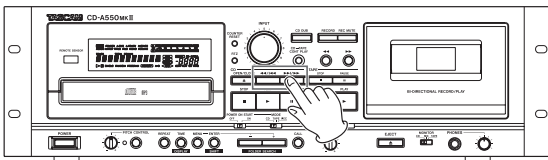

Selecting by track number

You can use the numeric keys (0–9) on the remote control to directly set a track for playback by number.

Track numbers can have up to two digits for audio CDs and up to three digits for data CDs.

- 1 Use the remote control numeric keys (0–9) to input the track number. Input the track number starting with the first digit as in the example below.

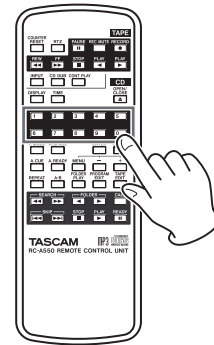

- To select track 1:

Press the “1” key one time.

- To select track 12:

Press the “1” key followed by the “2” key.

- 2 Press the CD PLAY key on the main unit or the remote control. The selected track begins to play.

NOTE

- If you press the READY key instead of the CD PLAY key, playback is paused at the beginning of the selected track.
- If you press the ENTER key instead of the CD PLAY key, the following occurs depending on whether the unit was playing before the track number was input in step 1 above.

Playing: the selected track starts to play.

Paused or stopped: the unit pauses at the beginning of the selected track.

- The numeric keys cannot be used to select a track when in program or random mode.

Selecting a folder (data CDs only)

When using a data CD, you can skip to the previous or next folder by pressing the FOLDER SEARCH -/+ keys while pressing and holding the SHIFT key on the main unit or by pressing the FOLDER ◀/▶ keys on the remote control. This will skip to the beginning of the first track in the previous or next folder. If you hold down one of these keys, you can skip through folders continually.

5 – Playing Back CDs

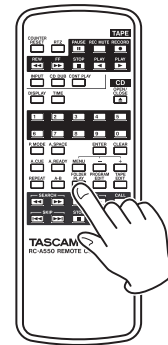
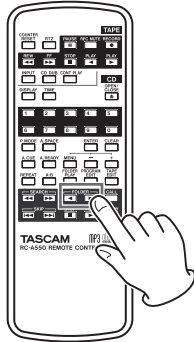
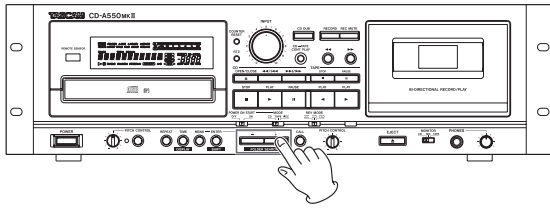

FOLDER: ON

NOTE

If folder playback mode is ON, when you skip to a different folder, it becomes the current folder. See “Folder playback (data CDs only)” on page 24 for details.

Search forward and backward

You can search forward and backward in a track while listening to its sound.

- 1 Play or pause the desired track.
- 2 Press and hold the ◀◀/▶▶ or ▶▶/▶▶ keys on the main unit or the SEARCH ◀◀/▶▶ keys on the remote control to start searching forward or backward.
- 3 Release the key that you are holding down to stop searching and return to the state (playback or pause) before you began searching.

Folder playback (data CDs only)

By turning folder playback mode ON when playing a data CD, you can set the playback area to the selected (current) folder.

Setting the folder playback mode with the remote control

Press the FOLDER PLAY key to turn folder playback mode ON and OFF and show the current setting on the display.

NOTE

The setting is shown for two seconds and then disappears from the display.

Press the FOLDER PLAY key again to change the setting.

When the folder playback function is ON, FOLDER appears on the display.

Setting the folder playback mode from the main unit

(See “Using the menu” on page 16 for details about making menu settings.)

- 1 When in standard display mode, press the MENU key on the main unit or the remote control to enter menu mode.
- 2 Use the -/+ keys on the main unit or the remote control main display to show FLDR PLAY? and press the ENTER key on the main unit or the remote control.

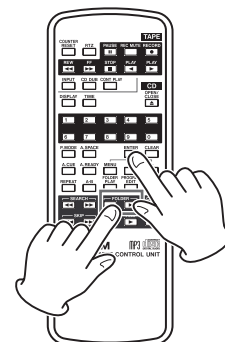
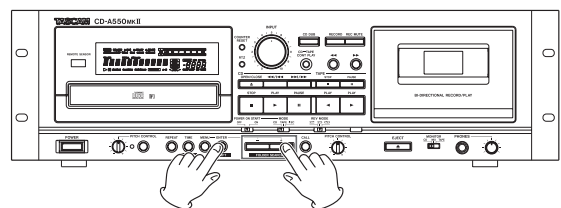

- 3 Use the -/+ keys on the main unit or the remote con-

trol to select “ON.”

- 4 Press the ENTER key on the main unit or the remote control to return to the standard display.

If the FOLDER PLAY item is set to “OFF,” the playback area is set as the entire data CD.

Selecting the current folder

When using the controls on the main unit, with playback stopped, press the FOLDER SEARCH $-/+$ keys while pressing and holding the SHIFT key to switch folders. When using the remote control, with playback stopped, press the FOLDER $\blacktriangle/\blacktriangleright$ keys to switch folders.

During this operation, folder titles (album titles) appear on the display.

If the folder was changed while playback was stopped, the unit returns to the standard display and playback is stopped at the beginning of the new folder.

If the folder was changed during playback or while paused, after changing to the desired folder using the procedures above, the folder is confirmed after one second elapses, and the folder name is shown on the display for two seconds.

NOTE

You cannot skip through folders during playback or when paused if the current playback mode is program mode.

CAUTION

The following settings are lost when the current folder is changed.

- Program
- CALL point

Playback modes

This unit can play tracks using the following four methods (playback modes).

Continuous playback (default setting)

The tracks on a disc are played back in numerical order.

NOTE

In folder playback mode, the tracks in the current playback folder on a data CD are played back in numerical order. See “Folder playback (data CDs only)” on page 24.

Single playback

The currently selected track is played once and then playback stops.

Random playback

The tracks on the disc are played back randomly regardless of track number. After all tracks have been played once, playback stops.

NOTE

In folder playback mode, the tracks in the current playback folder on a data CD are played back in random order. (See “Folder playback (data CDs only)” on page 24.)

Programmed playback

Tracks are played back in the programmed order. See “Programmed playback” on page 26 for details.

Selecting the playback mode

Use the dedicated P.MODE key on the remote control to select playback mode easily. You can also use the menu to set it from the main unit.

- Using the P.MODE key on the remote control

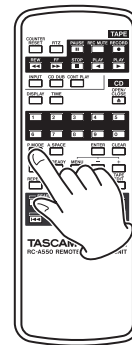

- 1 Each time you press the P.MODE key on the remote control, the playback mode changes.

Programmed playback (PROG), however, cannot be selected during playback or when paused. To select programmed playback, press the P.MODE key when playback is stopped or no CD is loaded. The current mode is shown with an indicator on the display as follows.

Display	Playback mode
No indicator	Continuous playback
SINGLE	Single playback
RANDOM	Random playback
PROGRAM	Programmed playback

NOTE

- Immediately after pressing the P.MODE key, the selected mode is shown in the main display area as follows.
 - Continuous playback mode selected: CONT
 - Single playback mode selected: SNGL
 - Random playback mode selected: RNDM
 - Programmed playback mode selected: PROG
- In this Owner’s Manual, explanations assume that the CD playback mode is set to CONTINUE (continuous playback mode) unless otherwise specified.

5 – Playing Back CDs

■ **Setting the playback mode with the menu**
(See “Using the menu” on page 16 for further explanation about how to use the menu.)

- 1 When in standard display mode, press the MENU key to enter menu mode.
- 2 Use the $-/+$ keys to show “PLAY MODE?” in the main display area, and press the ENTER key.



PLAY MODE?

- 3 Use the $-/+$ keys to select the desired playback mode (see above).
- 4 Press the ENTER key to return to the standard display. The selected playback mode is retained even if the power is turned OFF.

Programmed playback

If you set the playback mode to “PROGRAM” as described in “Selecting the playback mode” above, this unit can conduct programmed playback. In this mode, if you press the CD PLAY key on the main unit or the remote control, playback proceeds from the first track in the set program (program step “01”). Press the \lll and \ggg keys on the main unit or the SKIP \lll / \ggg keys on the remote control to skip to the previous/next program step.

You must set a program in advance to use programmed playback.

Setting the program

Use the remote control to set the program following the procedures below.

NOTE

You can set the program at any time regardless of the current playback mode.

- 1 When playback is stopped, press the PROGRAM EDIT key.

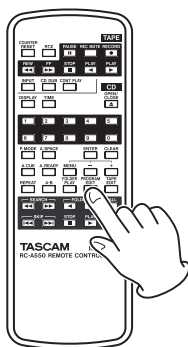

This starts program input mode and the following types of information appear on the display. The top example is

of an audio CD and the lower one is of a data CD.



TOTAL
0:00/00



TOTAL
---:--/00

In program input mode, the total program time and the number of programmed tracks is shown on the display. (However, the total program time is not shown for data CDs.) When no tracks have been added to the program, 0:00/00 is shown.

NOTE

Program input mode can be activated by selecting the PROGRAM EDIT item from the menu. (See “Using the menu” on page 16 for details about using the menu.)

- 2 Use the numeric keys or the SKIP \lll / \ggg keys to select a track to add as program step 01.

When using the numeric keys, input the leftmost digit first.



TRACK
01 3:26/01

[Audio CD]



TRACK
001 /01

[Data CD]

NOTE

When using a data CD, if you do not press the numeric keys or the SKIP \lll / \ggg keys for a second, the display switches from showing the track number to showing the file name.



FILE
FileName001

- 3 Press the ENTER key to add the selected track to the program and return to program input mode, which allows you to add the next program step.
- 4 Repeat steps 2 and 3 above to add as many tracks as you desire in order.
- 5 When finished program setting, to exit program input mode, press the ENTER key or the PROGRAM EDIT key to return to the standard display.

Pause program

You can set the program to pause by entering “0” for a track number using the numeric keys. During

5 – Playing Back CDs

programmed playback, when the program reaches a step set to pause, the unit's CD player pauses. You must press the CD PLAY key to advance to the next program step.

NOTE

- The same track can be added to the program multiple times.
- Press the remote control CLEAR key to remove the last added track from the program.
- Press the CD STOP key to remove all tracks from the program.
- The program can have a maximum of 99 tracks. If you try to add more than 99 tracks, the "PGM Full!" error message appears on the display.
- If the total playback time of the programmed tracks exceeds 999 minutes and 59 seconds "----: --" is shown on the display.
- You cannot add a pause as the final program step.
- You cannot add a pause that would result in two consecutive pauses.
- In program input mode, use the -/+ keys to change program steps and confirm their contents.
- Programmed playback mode and the program settings are retained even if the power is turned OFF.
- In programmed playback mode, playback is impossible if no tracks have been added to the program.

Clearing the entire program

In addition to pressing the CD STOP key to clear the entire program in program input mode, as described above, all the following actions also clear the entire program.

- Opening the disc tray
- Turning the folder playback function ON or OFF
- Changing the playback mode
- Changing the folder

Checking the program

You can check the contents of the program.

- 1 Press the PROGRAM EDIT key on the remote control to put the unit into program setting mode.
- 2 Press the -/+ keys to cycle through the program steps shown on the display, starting at the first. Pressing the - key cycles through the tracks in the program in reverse order from the last added step.



Editing the program

You can edit a program that has already been created.

- 1 Press the remote control PROGRAM EDIT key to put the unit into program input mode.
- 2 Use the -/+ keys to select the program step that you want to edit.

■ Replacing a track

Use the numeric keys or SKIP ◀◀/▶▶ keys to select the replacement track and press the ENTER key.

The selected track replaces the track in the step and the unit returns to program input mode.

■ Erasing a track

Press the remote control CLEAR key to remove the track from the program.

All following tracks are moved one step forward in the program.

Playback time display mode

You can set what is shown on the display when in playback time display mode.

- 1 Press the main unit TIME/DISPLAY key (or the remote control TIME key) to cycle through the three types of time display.

The currently selected display mode is shown above the main display.

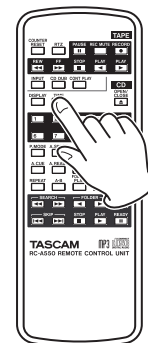
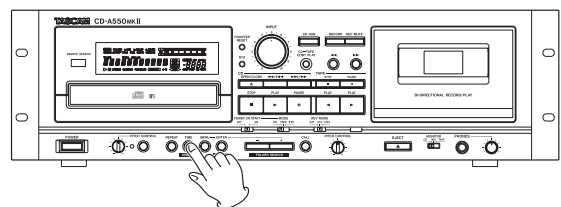

No indicator

The elapsed time of the current track is shown.

"REMAIN" indicator

The remaining time of the current track is shown.

"TOTAL" and "REMAIN" indicators

5 – Playing Back CDs

The total remaining time is shown.

NOTE

- When stopped, the total time is always shown regardless of whether the "TOTAL" or "REMAIN" indicators are shown.
- When a data CD is loaded, the remaining time and total remaining time during playback and the total time when playback is stopped are not shown. (Only the number of tracks or the track number is shown; "--" appears in place of the time display.)
- In programmed playback mode, the program total elapsed time and remaining time are shown.
- The time display mode setting is retained even if the power is turned OFF.

Text information display mode

Text information can be shown on the display. ID3 tag information can be shown for data CDs and CD text information can be shown for audio CDs. This information cannot be shown if it is not recorded in the disc or file.

- 1 To show text information, press the TIME/DISPLAY key while holding the SHIFT key on the main unit (or press the DISPLAY key on the remote control). Press again to cycle through the available text information (see below).

An indicator for the currently selected display mode is shown above the main display. The contents shown differ during playback and when paused and between data CDs and audio CDs.



[Audio CD/Data CD title]



[Data CD file name]

During playback

- **TITLE** indicator
The track title is shown.
- **ARTIST** indicator
The track artist name is shown.
- **FILE** indicator (data CDs only)
The file name is shown.

When paused

- **ALBUM TITLE** indicator

The album title is shown (when using an audio CD).

The folder name or volume label is shown (when using a data CD).

- **ALBUM ARTIST** indicator (audio CDs only)

The album artist name is shown.

- 2 To return to time display, press the TIME key on the main unit or the remote control.

Repeat playback

This unit can play all tracks repeatedly or repeat a selected section of one track (A–B repeat playback).

Ordinary repeat playback

Press the REPEAT key on the main unit or the remote control to turn repeat playback ON (REPEAT appears on the display) and play all tracks repeatedly.

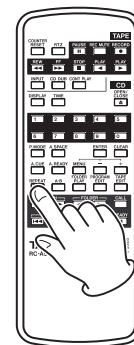
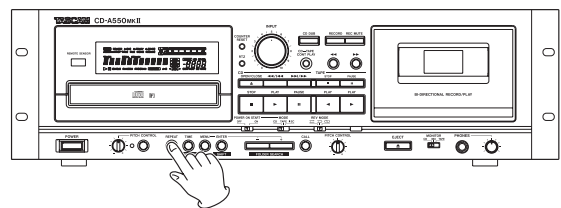

NOTE

- If the folder playback function is ON when using a data CD, only the tracks in the current folder are played.
- If repeat playback is turned ON when programmed playback mode is active, the tracks in the program are played back repeatedly. If repeat playback is turned ON when single playback mode is active, the currently selected track is played back repeatedly.
- When the auto ready function is ON, playback pauses at the start of each track regardless of whether the repeat function is ON or OFF. Turn the auto ready function OFF to conduct continuous repeat playback.

If repeat playback is turned ON during playback, playback continues without interruption and repeats from the beginning of the first track after the end of the

5 – Playing Back CDs

last track is reached. If repeat playback is turned ON when playback is stopped, it begins when the CD PLAY key is pushed. Press the REPEAT key on the main unit or the remote control again to turn repeat playback OFF (REPEAT disappears from the screen).

NOTE

The repeat function ON/OFF setting is retained even if the power is turned OFF.

A–B repeat playback

Repeat playback of a selection of a track (A–B) is possible.

- 1 During playback or when paused, press the remote control A–B key at the point where you want to set the start point (A) for the repeat playback selection. REPEAT and A– appear on the display and B blinks.

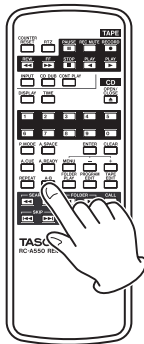

NOTE

If you press the REPEAT key, the repeat playback start point (A) is canceled and "REPEAT" and "A–" disappear from the display.

- 2 Press the remote control A–B key again at the point where you want to set the end point (B) for the repeat playback section. REPEAT and A–B appear on the display, the repeat section (A–B) is confirmed and A–B repeat playback begins.

NOTE

The A–B repeat playback section cannot span more than one track.

■ Stopping A–B repeat playback

Press the remote control A–B key or the REPEAT key.

REPEAT and A–B disappear from the display and A–B repeat playback stops.

NOTE

- If A–B repeat playback is stopped during playback, the track continues playing past the B point.
- Press the CD STOP key to stop CD playback and cancel the designated repeat section (A–B).

Pitch control

This unit can change the pitch (sound frequency and playback speed) during CD playback (pitch control playback).

Follow the procedures below to use pitch control playback.

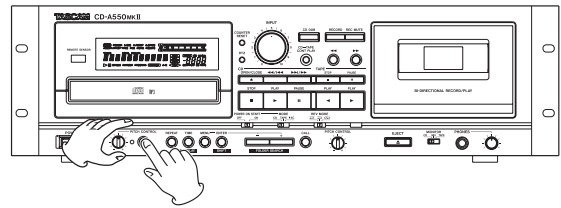

- 1 Press the PITCH CONTROL key on the main unit to turn pitch control playback ON. The indicator next to the PITCH CONTROL key lights.
- 2 Use the CD PITCH knob on the main unit to adjust the pitch. You can raise or lower the pitch by up to 12.5%.

■ Turning pitch control playback OFF

Press the PITCH CONTROL key on the main unit again to turn pitch control playback OFF.

The PITCH CONTROL indicator turns off.

CAUTION

- During playback, turning pitch control playback ON or OFF might cause the playback sound to skip momentarily.
- Using pitch control playback with a data CD (MP3, WAV) sometimes causes the playback sound to skip.

Auto cue function (audio CDs only)

If the auto cue function is ON, when a track is selected, the silence at the beginning of the track is skipped and the unit pauses at the position where the "signal" actually starts in the track. This allows sound to be heard immediately after playback is started.

NOTE

- The auto cue function cannot be used with data CDs.
- When the auto cue function is ON, even if a track is selected during playback, playback pauses at the position where the "signal" actually starts after the track is selected.

You can also set the audio signal detection threshold level (auto cue level) for use with the auto cue function. In short, this unit recognizes signals above the auto cue level as "signal" and ignores any signal below the auto cue level as "silence."

Follow the procedures below to use the menu to turn the auto cue function ON and OFF and set the auto cue level. (See "Using the menu" on page 16 for details)

5 – Playing Back CDs

about how to use the menu.)

- 1 When in standard display mode, press the MENU key on the main unit or the remote control to enter menu mode.
- 2 Use the $-/+$ keys on the main unit or the remote control to show **AUTO CUE?** on the main display, and press the ENTER key.

AUTO CUE?

- 3 Use the $-/+$ key to select the desired value from the following options.

The auto cue function is turned ON by all values besides “OFF” and they set the auto cue level.

Options: OFF (default value), -24dB, -30dB, -36dB, -42dB, -48dB

- 4 Press the ENTER key to return to the standard display.

When the auto cue function is ON, **A.CUE** appears on the display.

NOTE

- The auto cue setting is retained even if the power is turned OFF.
- The auto cue function cannot be used with data CDs.

Turning auto cue ON and OFF using the remote control A.CUE key

Press the A.CUE key on the remote control to turn the auto cue function ON and OFF.

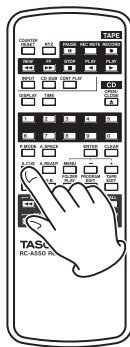

NOTE

- The auto cue setting is retained even if the power is turned OFF.
- The auto cue level cannot be set with the A.CUE key.

Auto ready function

When the auto ready function is ON, after playback of a track finishes, playback pauses at the start of the next track.

Press the A.READY key on the remote control to turn the auto ready function ON and OFF.

A.READY appears on the display when the auto ready function is ON.

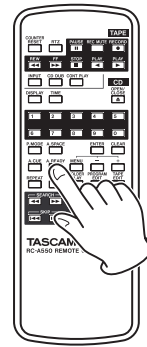

Turning the auto ready function ON and OFF from the main unit

The auto ready function can be turned ON and OFF from the main unit using the menu. (See “Using the menu” on page 16 for details about how to use the menu.)

- 1 When in standard display mode, press the MENU key on the main unit or the remote control to enter menu mode.
- 2 Use the $-/+$ keys on the main unit or the remote control to show **AUTO READY?** on the main display, and press the ENTER key.

AUTO READY?

- 3 Use the $-/+$ keys to choose “ON” or “OFF” (default value).
- 4 Press the ENTER key to return to the standard display.

NOTE

The auto ready setting is retained even if the power is turned OFF.

Auto space function

When the auto space function is ON, a four-second space is automatically added between tracks during playback.

In other words, after a track finishes playing, the CD pauses for four seconds before the next track starts to play.

Press the A.SPACE key on the remote control to turn the auto space function ON and OFF.

When the auto space function is ON, A.SPACE appears on the display.

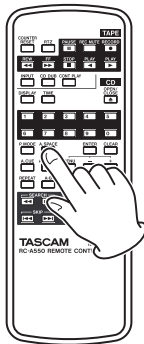

NOTE

To use the auto space function, the auto ready function must be OFF. The auto space function does not work if the auto ready function is ON.

Turning the auto space function ON and OFF from the main unit

The auto space function can be turned ON and OFF from the main unit using the menu. (See “Using the menu” on page 16 for details about how to use the menu.)

- 1 When in standard display mode, press the MENU key on the main unit or the remote control to enter menu mode.
- 2 Use the -/+ keys on the main unit or the remote control to show AUTO SPACE? on the main display, and press the ENTER key.

AUTO SPACE?

- 3 Use the -/+ keys to select “ON” or “OFF” (default value).
- 4 Press the ENTER key to return to the standard display.

NOTE

The auto space setting is retained even if the power is turned OFF.

Incremental play

If the Incremental play function is ON, pressing the CD PLAY key during playback cause the next track to play from its beginning, and pressing the CD STOP key during playback causes the unit to pause at the beginning of the next track.

NOTE

If the CD PLAY key is pressed when the incremental play function is ON, playback resumes from the paused position, and if the CD STOP key is pressed when paused, playback stops.

Moreover, if the CD PLAY key is pressed during playback of the final track, the first track begins to play, while if the CD STOP key is pressed, playback pauses at the first track.

Use the menu to turn the incremental function ON and OFF. (See “Using the menu” on page 16 for details about how to use the menu.)

- 1 When in standard display mode, press the MENU key on the main unit or the remote control to enter menu mode.
- 2 Use the -/+ keys on the main unit or the remote control to show “INCR PLAY?” on the main display, and press the ENTER key.

INCR PLAY?

- 3 Use the -/+ keys to select “ON” or “OFF” (default value).
- 4 Press the ENTER key to return to the standard display.

When the incremental play function is ON, TRACK blinks on the display during playback.

NOTE

The incremental play setting is retained even if the power is turned OFF.

5 – Playing Back CDs

Call function

The call function allows you to return to the last point where playback was started from a paused state (call point) and pause again.

Press the CALL key on the main unit or the remote control during playback or when stopped to use the call function.

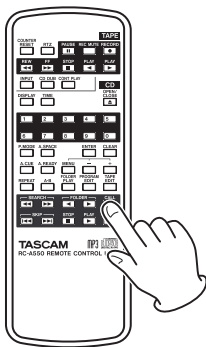
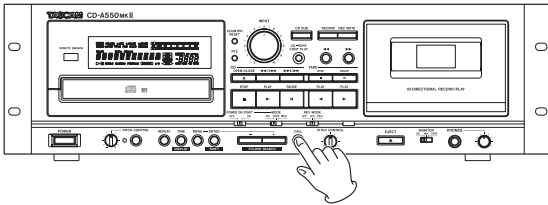

The call point is erased after any of the following operations.

- The power is turned OFF
- The disc tray is opened
- The playback mode is changed
- The folder playback function ON/OFF setting is changed
- The folder is changed

NOTE

- If you press the CALL key when no call point has been set, "No Call Pt!" appears on the main display.
- The call function cannot be used during random playback mode.

Resume playback

Turn the resume playback function ON to allow playback to restart from the position where playback was last stopped (resume point).

When the resume playback function is ON, RESUME appears on the display.

- 1 When in standard display mode, press the MENU key on the main unit or the remote control to enter menu mode.
- 2 Use the $-/+$ keys on the main unit or the remote control to show "RESUME?" on the main display, and

press the ENTER key on the main unit or the remote control.

RESUME?

- 3 Use the $-/+$ keys on the main unit or the remote control to select "ON" or "OFF" (default value).
- 4 Press the ENTER key to return to the standard display.

NOTE

- The resume point ON/OFF setting is retained even if the power is turned OFF.
- The resume point is erased after any of the following operations.
 - The disc tray is opened
 - The folder playback function ON/OFF setting is changed
 - The folder is changed
 - The playback mode is changed

EOM function

Turn the EOM (End Of Message) function ON to have the unit start blinking the playback time display when the audio CD reaches the remaining playback time set in advance. Use the menu to set the EOM function. (See "Using the menu" on page 16 for details about how to use the menu.)

- 1 When in standard display mode, press the MENU key on the main unit or the remote control to enter menu mode.
- 2 Use the $-/+$ keys on the main unit or the remote control to show "EOM DISP?" on the main display, and press the ENTER key.

EOM DISP?

- 3 Use the $-/+$ keys to choose one of the following settings.

Options: OFF (default value), 5sec, 10sec, 15sec, 20sec, 25sec, 30sec, 35sec

All the settings except for "OFF" turn the EOM function ON and indicate the number of seconds before the end of the track when the unit's playback time starts to blink on the display.

- 4 Press the ENTER key to return to the standard display.

NOTE

This setting is retained even if the power is turned OFF.

6 – Playing Back Cassette Tapes

This chapter explains the playback functions of this unit's cassette recorder. The following explanation assumes that this unit's power is ON and that a cassette tape with a recorded signal has been loaded with the A side facing forward.

Preparation for tape playback

Selecting the reverse mode

Use the REV MODE switch to set the reverse mode.

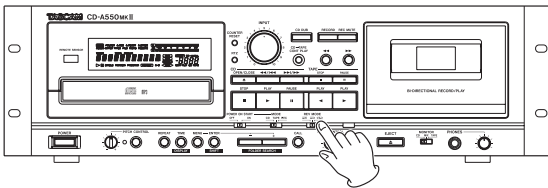

↻: Repeat playback of both A and B sides five times

⏪: Play both A and B sides once each and then stop playback

⏹: Play either the A or the B side once and then stop playback

Playing a tape

Press the TAPE PLAY [▶] key on the main unit or the remote control to play the A side or the TAPE PLAY [◀] key to play the B side.

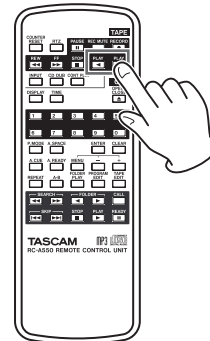
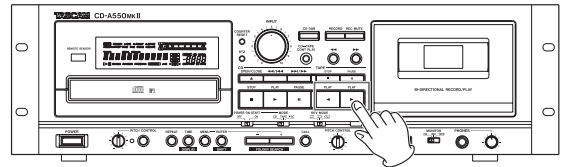

TIP

You can play both a CD and a cassette tape at the same time.

Stopping playback

Press the TAPE STOP key.

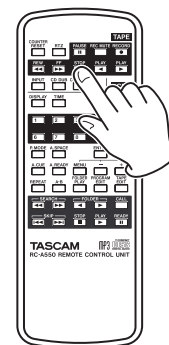
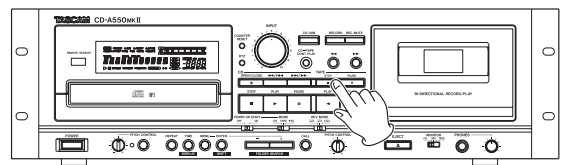

6 – Playing Back Cassette Tapes

■ To fast-forward or rewind

Press the TAPE ►► or ◀◀ key on the main unit or the remote control. Press the TAPE STOP key to stop fast-forwarding or rewinding.

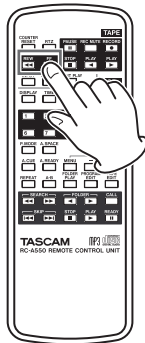
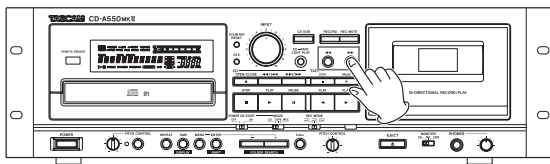

Tape counter

The tape counter value increases as the tape runs from left to right, and it decreases as it runs from right to left.

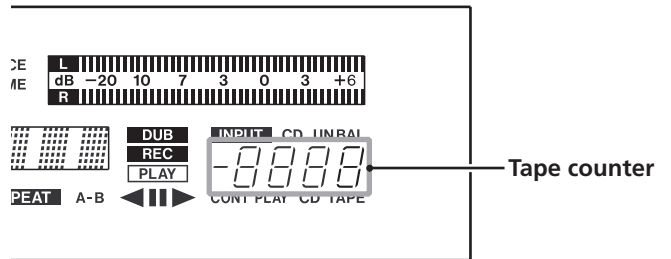

Press the COUNTER RESET key on the main unit or the remote control to reset the tape counter to "0000."

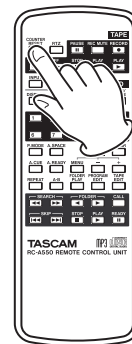
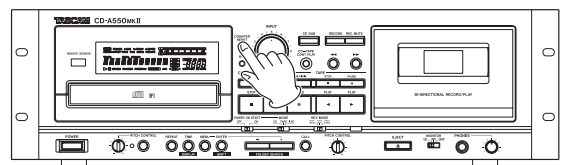

6 – Playing Back Cassette Tapes

RTZ

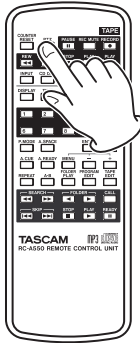
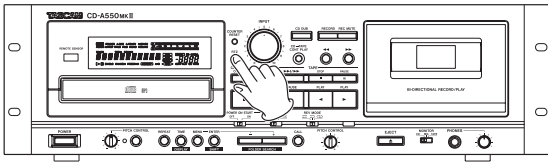

Press the RTZ key on the main unit or the remote control to return the cassette tape playback position to the counter zero point (0000). The RTZ key does not function, however, if pressed when the counter value is between “9996” and “0004.”

TIP

RTZ is an abbreviation for “return to zero.”

Pitch control

The pitch of the sound can be changed during cassette playback.

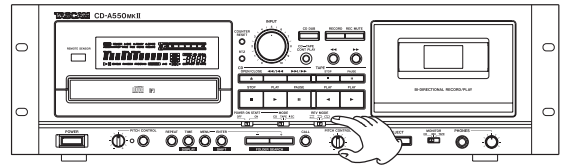

Turn the TAPE PITCH CONTROL knob on the main unit to the right to increase the playback speed and raise the playback pitch. Turn it to the left to slow the playback speed and lower the playback pitch. The knob has an indentation at the center, which is the position for playback at the standard pitch. The pitch can be raised or lowered by up to 10%.

NOTE

- *Cassette playback pitch cannot be controlled with the remote control.*
- *Although there is a PITCH CONTROL key to turn the CD pitch control ON and OFF, there is no key to turn the cassette recorder pitch control ON and OFF. To play a tape at the standard pitch, set the PITCH CONTROL knob to its center (indented) position.*

7 – Recording Cassette Tapes

This unit can record to cassette tapes. The following procedures explain how to prepare for recording by setting the reverse mode and selecting the input and then actual recording. This explanation assumes that the unit's power is ON and that a recordable (write-protect tabs not removed) cassette tape has been loaded already.

Preparing to record

Selecting the reverse mode

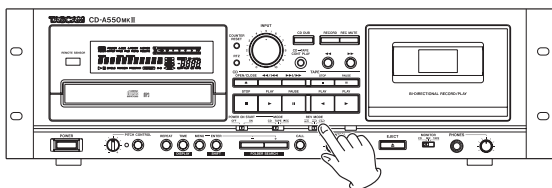

Use the REV MODE switch to set the unit to record on one or both sides.

↔: After recording on both A and B sides, the unit stops.

→: After recording on either the A or B side, the unit stops.

NOTE

If ↔ is selected, the unit functions as though ↔ had been selected. In other words, after recording on both A and B sides, the unit stops.

Selecting the recording source

■ Using the INPUT key on the remote control

The remote control INPUT key can be used to select the input source. Press the key repeatedly to cycle through the input sources.

The active input source appears on the main area of the display.

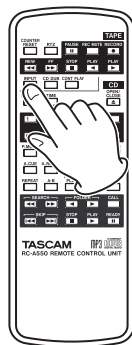

INPUT CD: the playback signal from this unit's CD player

INPUT UNBAL: the signal input through the TAPE INPUT (UNBALANCED) jacks on the rear panel

■ Using the menu

You can also use the menu to set the record source signal (input source).

- 1 When in standard display mode, press the MENU key on the main unit or the remote control to enter menu mode.
- 2 Use the -/+ keys on the main unit or the remote control to show "TAPE INPUT?" on the main display, and press the ENTER key on the main unit or the remote control.

TAPE INPUT?

- 3 Use the -/+ keys on the main unit or the remote control to select the input source from the following options.

CD: the playback signal from this unit's CD player.

UNBAL (default value): the signal input through the TAPE INPUT (UNBALANCED) jacks on the rear panel

- 4 Press the ENTER key on the main unit or the remote control to return to the standard display.

NOTE

The CD dubbing function is convenient when recording a CD. See "Dubbing a CD to a tape" on page 37 for details.

7 – Recording Cassette Tapes

Recording

After completing the above preparations, set the recording level and begin recording.

- 1 Press the RECORD key on the main unit or the remote control.

This makes the unit ready to record ready. The meters on the display show the input level and the REC indicator appears.

The sound of the recording source is output through the TAPE COMMON OUTPUT jack. This sound can also be output from the PHONES jack by setting the MONITOR switch to MIX or TAPE.

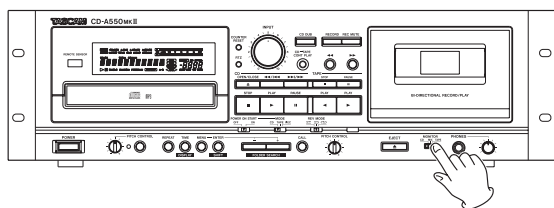

- 2 To set the record level, start playback of the recording source and adjust the INPUT knob on the main unit to set the optimal level while looking at the meters. Adjust the input so that the meters indicate 0 dB at its highest level.

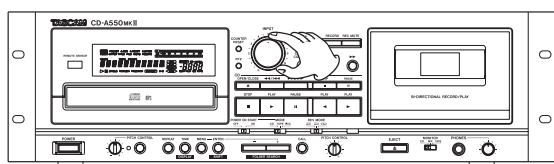

- 3 Select and confirm the tape operation direction.

The current tape operation direction is shown on the display with the reverse (◀) or forward indicator (▶). To record in the opposite direction, press the TAPE PLAY key of the desired direction to change the tape operation direction.

- 4 Press the TAPE PLAY or PAUSE key on the main unit or the remote control to start recording.

■ Stopping recording

Press the TAPE STOP key.

■ Pausing recording

Press the PAUSE key. Press the PAUSE key again or the TAPE PLAY key to restart recording.

Recording mute function

During recording, press the REC MUTE key on the main unit or the remote control to record about four seconds of silence and then pause recording. Press the TAPE PLAY or PAUSE key on the main unit or the remote control to restart recording.

Press and hold the REC MUTE key on the main unit or the remote control for more than four seconds to create a silence of longer than four seconds. The unit pauses when the key is released after being held for more than four seconds.

To create a silence of less than four seconds, press the PAUSE key during the recording of the silence. This pauses the unit.

NOTE

- If you press the REC MUTE key again during the recording of silence, ordinary recording restarts.
- If you press the REC MUTE key when recording is paused, the unit will record four seconds of silence and then pause again.

Dubbing a CD to a tape

The CD dubbing function allows you to press the CD DUB key on the main unit or the remote control to dub the CD loaded in the unit to a cassette tape with one touch.

NOTE

- The input source does not need to be selected.
- The record level is automatically set to the default setting, but you can also set it manually. (See "Adjusting the record level when dubbing" on page 38.)
- The CD programmed playback, random playback, single playback, repeat playback and other functions can be used as desired when dubbing a CD.
- The auto ready and incremental play functions cannot be used during CD dubbing.

The following explanations assume that the CD to be dubbed and a recordable cassette tape have been loaded in the unit.

7 – Recording Cassette Tapes

Basic dubbing (recording to the A side of a tape from its beginning)

When playback is stopped, press the CD DUB key on the main unit or the remote control.

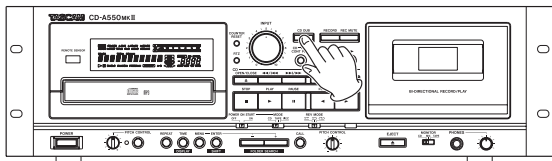

The tape automatically rewinds to the start of the A side, and the tape counter resets to “0000.” The CD pauses at the beginning of its first track. After the tape records about eight seconds of silence (to avoid the leader tape), dubbing starts with the CD beginning playback and the cassette recorder beginning recording at the same time. (The DUB indicator appears on the display.)

NOTE

- When the CD playback stops or the tape end is reached, the tape stops (the tape side end that it stops at depends on the reverse mode) and dubbing ends.
- When dubbing in two-side recording mode, if the last track being recorded to the first side of the tape is not recorded completely before the operation direction reverses, that track is recorded again from its beginning on the second side of the tape.
- When dubbing in two-side recording mode, nothing is recorded for eight seconds after the operation direction is reversed. (CD playback pauses while the cassette recorder continues in record mode.)
- Press the TAPE or CD STOP key to stop dubbing at any time.

Adjusting the record level when dubbing

The recording level is automatically set when dubbing a CD to a tape by default, but the record level can be adjusted with the INPUT knob when dubbing.

- 1 Set "CD" as the recording source. (See “Selecting the recording source” on page 36.)
- 2 When in standard display mode, press the MENU key on the main unit or the remote control to enter menu mode.
- 3 Use the -/+ keys on the main unit or the remote control to show "DUB LEVEL?" on the main display, and press the ENTER key on the main unit or the remote control.

DUB LEVEL?

- 4 Use the -/+ keys on the main unit or the remote control to select “VARI.”

Options: FIX (default value), VARI

- 5 Press the ENTER key on the main unit or the remote control to return to the standard display.
- 6 Press the RECORD key on the main unit or the remote control to make the unit record ready and enable monitoring of the recording source.
- 7 Play the CD and observe the recording level meters on the display.
- 8 Use the INPUT knob to adjust the recording level. (See “Recording” on page 37.)
- 9 Press the CD STOP key to stop the CD and the TAPE STOP key to take the unit out of record ready mode.
- 10 Press the CD DUB key on the main unit or the remote control to conduct dubbing in the same way as described above in “Basic dubbing.”

7 – Recording Cassette Tapes

Using the TAPE EDIT function

Using the TAPE EDIT function, this unit can follow an automatically prepared program and dub a CD according to the tape length.

With the TAPE EDIT function, starting with the first track, CD tracks that total less than the length of the tape side are recorded in order to the A side of the tape. Then, recording continues from the next track in order to the B side.

- 1 When CD playback is stopped, press the TAPE EDIT key on the remote control to enter TAPE EDIT mode. The main display appears as shown below.

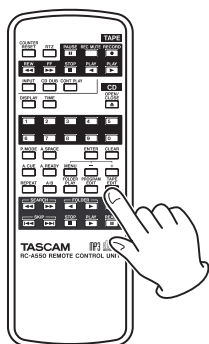

TAPE> C 30

NOTE

You can also select the TAPE EDIT menu item to enter TAPE EDIT mode.

- 2 Use the $-/+$ keys on the main unit or the remote control to select the length (in minutes) of the tape being used.

Options: 30 (default), 46, 54, 60, 80, 90, 120

CAUTION

You can select “120” (for a 120-minute tape) when using the TAPE EDIT function, but use of tapes longer than 90 minutes with this unit is not recommended. (See “Types of cassette tapes that are not recommended for use with this unit” on page 9.)

- 3 Press the ENTER key on the main unit or the remote control.

If a program has not already been set, this unit automatically creates a program to fit the length of the tape.

If a program has already been set, “OVERWRITE?” appears in the main area of the display.

Press the ENTER key again to discard the current program and automatically create a program to fit the length of the tape.

Recording from the middle of a tape

- 1 Set the tape at the position from where you want to start recording.
- 2 Press the RECORD key on the main unit or the remote control to make the unit record ready. REC and II appear on the display.
- 3 Press the CD DUB key on the main unit or the remote control. Dubbing in the set recording direction begins from that position.

8 – Other Functions

Continuous playback of both the CD and the tape

This unit can alternately play the loaded CD and the cassette tape. In other words, tape playback starts when CD playback ends and CD playback starts when tape playback ends.

Before using the following procedures, load a recorded cassette tape and a CD.

- 1 Press the CD-TAPE CONT PLAY key on the main unit or the CONT PLAY key on the remote control.

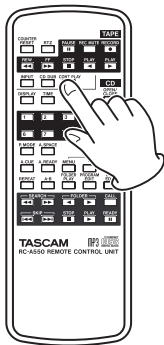
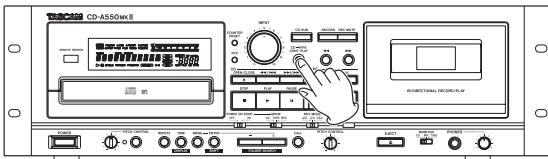

- 2 Press the CD or TAPE PLAY key.

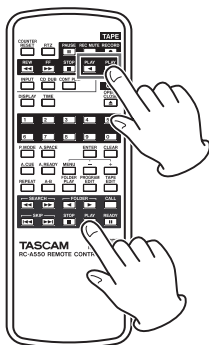
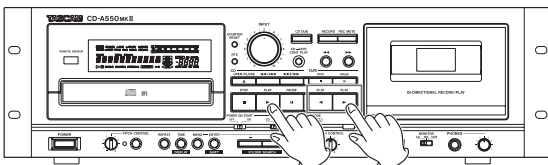

Depending on the key pressed, the CD or tape begins to play. When playback of the selected media ends, playback of the other media automatically starts.

During continuous playback mode, the CONT PLAY indicator appears on the display, and the indicator for the media currently being played (TAPE or CD) blinks.

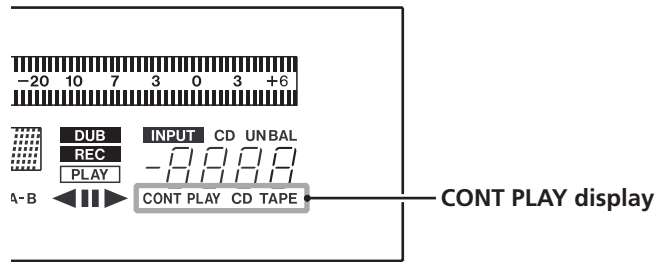

NOTE

- If you press the TAPE STOP key to manually stop playback, the other media automatically starts playing.
 - When playing a CD in REPEAT mode, tape playback does not start until you manually stop the CD playback. Likewise, when the tape is in auto reverse mode (↔), CD playback does not start until both sides of the tape have played five times or playback is stopped manually.
- 3 To stop using continuous playback mode, press the CD-TAPE CONT PLAY key on the main unit or the CONT PLAY key on the remote control again.

NOTE

If the factory default settings have not been changed, the CD playback signal is output from the CD OUTPUT jacks and the tape playback signal is output from the COMMON OUTPUT jacks independently. Set the menu COMMON OUT item to "MIX" or "AUTO" to output both the tape and CD signals from the COMMON OUTPUT jacks. (See "Setting the common output signal" on page 19.)

8 – Other Functions

Power-on start

This unit can be set to automatically start playing a CD or cassette tape when its power is turned ON. The unit can also be set to automatically start recording to a cassette tape.

You can, for example, connect this unit's power cord to a timer that controls the power supply in order to make it record or play automatically at a specific time.

- 1 Load a CD or cassette for playback, or a cassette for recording into the unit.
- 2 Set the POWER ON START switch to ON.

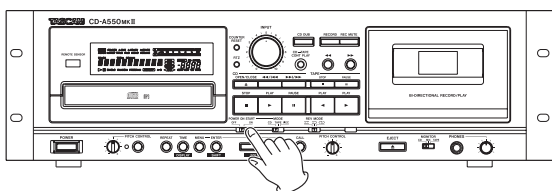

- 3 Set the MODE switch to the desired position.

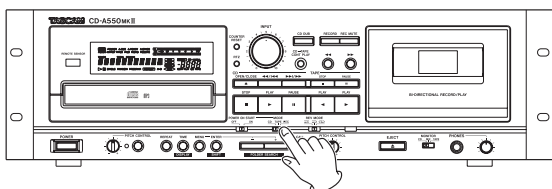

CD: CD playback starts when the power is turned ON.

TAPE: Cassette tape playback starts when the power is turned ON.

REC: Cassette tape recording starts when the power is turned ON.

If using a timer, use it to turn the power to this unit OFF.

With this setting ON, the unit functions as set automatically as soon as power is supplied to it.

Restoring default settings

The following items can be restored to their factory default settings.

- All menu items
- Repeat playback function (OFF)
- Playback time display (track elapsed time)
- Text information display (album name)
- CD pitch control (OFF)
- Program setting (none)

- 1 When in standard display mode, press the MENU key on the main unit or the remote control to enter menu mode.
- 2 Use the -/+ keys on the main unit or the remote control to show "DEFAULT?" on the main display, and press the ENTER key on the main unit or the remote control. "SURE?" appears on the display to confirm that you want to restore the default settings.

DEFAULT?

SURE?

- 3 Press the ENTER key on the main unit or the remote control to confirm and restore the default settings.

8 – Other Functions

Mono playback

The CD and cassette tape playback signal can be output to mono using a menu setting.

When the mono playback function is ON, MONO appears on the display.

- 1 When in standard display mode, press the MENU key on the main unit or the remote control to enter menu mode.
- 2 Use the $-/+$ keys on the main unit or the remote control to show “MONO OUT?” on the main display area, and press the ENTER key on the main unit or the remote control.



MONO OUT?

- 3 Use the $-/+$ keys on the main unit or the remote control to select “ON” or “OFF” (default value).

When set to “ON,” a mono signal is output through the CD OUTPUT, TAPE COMMON OUTPUT and PHONES jacks.

- 4 Press the ENTER key to return to the standard display.

NOTE

- This setting is retained even if the power is turned OFF.
- The CD digital output is not affected by this setting; it cannot be set to mono.

Viewing information about this unit

Checking versions

You can check the unit’s firmware version and build number.

- 1 When in standard display mode, press the MENU key on the main unit or the remote control to enter menu mode.
- 2 Use the $-/+$ keys on the main unit or the remote control to show “VERSION?” in the main display area, and press the ENTER key on the main unit or the remote control.



VERSION?

- 3 Use the $-/+$ keys on the main unit or the remote control to cycle through showing the version (VER>), build number (BUILD>) and CD drive version (CD D>).
- 4 When finished checking, press the ENTER key to return to the standard display.

Checking the motor operation time

You can check the operation time of the unit’s CD player and cassette recorder.

- 1 When in standard display mode, press the MENU key on the main unit or the remote control to enter menu mode.
- 2 Use the $-/+$ keys on the main unit or the remote control to show “MOTOR TIME?” in the main display area, and press the ENTER key on the main unit or the remote control.



MOTOR TIME?

- 3 Use the $-/+$ keys on the main unit or the remote control to switch between showing the CD player motor operation time (CD>) and the cassette recorder motor operation time (TAPE>).
- 4 When finished checking, press the ENTER key to return to the standard display.

Operation messages

The following messages are shown on the main display according to the operation of this unit.

Message	Message lit or blinking	Meaning	Response
Close	Lit	The disc tray is closing.	
No Disc	Lit	There is no disc or the disc cannot be verified.	
No Files	Lit	The disc has no files that can be played back.	Load a disc that has MP3 or WAV files.
No Filename	Lit	The file name cannot be shown.	Text information must be 7-bit ASCII compatible text to be displayed.
No Name	Lit	There is no artist data or no data that can be displayed.	Text information must be 7-bit ASCII compatible text to be displayed.
No Title	Lit	There is no title data or no data that can be displayed.	Text information must be 7-bit ASCII-compatible text to be displayed.
Open	Lit	The disc tray is open.	
OVERWRITE?	Lit	This is confirming that you want to overwrite the existing program.	
PGM CLEAR!	Lit	This informs that the program has been cleared completely.	
TOC Reading	Lit	TOC information is being read.	

Warning messages

If an operation cannot be completed, one of the following messages is shown. It will appear for about two seconds before disappearing automatically.

Message	Message lit or blinking	Meaning	Response
No Call Pt!	Lit	A call point has not been set.	Set a CALL point. (Press READY then PLAY.)
No Program!	Lit	No program has been created.	Add tracks to the program.
PGM Full!	Lit	You cannot add more than 99 tracks to the program.	Either stop trying to add to the program or clear the program.

9 – Message list

Error messages

If one of the following error messages is shown, please refer to the Response column and try to resolve it. If this does not correct the problem, please contact a TEAC repair center.

CD Drive

Message	Message lit or blinking	Meaning	Response
Comm Error	Blinking	Cannot communicate with the CD drive.	Please contact a TEAC repair center.
Comm Error	Lit	An error occurred during communication with the CD drive.	Please contact a TEAC repair center.
Decod Error	Lit	The file type is not supported or otherwise could not be played.	Change the disc.
Disc Error	Lit	The TOC or file system could not be read, or focus adjustment was not possible.	Clean or change the disc.
Drive Error	Lit	The CD drive hardware is broken.	Please contact a TEAC repair center.
Read error	Lit	The track cannot be accessed.	Clean or change the disc.

Cassette deck

Message	Message lit or blinking	Meaning	Response
Err	Lit	The cassette mechanism is broken.	Please contact a TEAC repair center.

10 – Troubleshooting

If you have problems with this unit, please check the following points before seeking repair. If you are still unable to resolve the problem, please contact the shop where you purchased the unit or a TEAC repair center.

■ The power does not turn ON.

- Is the power plug completely plugged into the outlet?

■ The unit does not respond to the remote control.

- Are charged batteries in the remote control?

■ There is no sound.

- Confirm the connections with the monitoring system.
- Confirm the amp volume and settings.
- The sound from tape playback is never output from the **CD OUTPUT** jacks. Moreover, the signals output from the **COMMON OUTPUT** jacks depend on the menu **COMMON OUT** item setting.

■ There is unwanted noise.

- Are the connecting cables all properly connected and functioning?

■ The playback sound is mono.

- Is the **MONO OUT** item in the menu set to “ON”?

■ Cannot record to the cassette tape.

- Has the write-protection tab been removed from the cassette to prevent the unintentional erasure of recordings?
- Is the cassette recorder stopped or in record ready mode?
- Recheck the input connections.
- Is the **INPUT** knob turned up?
- Is the **TAPE INPUT SOURCE** item in the menu set to the correct input source?

■ The playback sound of the cassette tape is strange.

- Is the head or pinch roller dirty? Use a cleaning fluid to clean it if dirty.
- If a head has become magnetized, demagnetize it.
- Is pitch control set to a positive or negative value?

■ Cannot dub from a CD to a cassette.

- Is the CD playing or paused?
- Has the write-protection tab been removed from the cassette to prevent the unintentional erasure of recordings?

■ Cannot play a CD.

- If using an MP3 file, confirm that its bit rate is one that can be used by this unit.
- Is the disc damaged or dirty?

■ Cannot play all of a data CD.

- Is the **FOLDER PLAY** item in the menu “ON”?

11 – Specifications

Ratings

CD player

■ Compatible disc formats

CD-DA (12-cm/8-cm), CD-ROM (12-cm/8-cm) ISO 9660 LEVEL 1/2/ROMEO/JOLIET format (CD-R/CD-RW disc compatible)

■ MP3 playback specifications

Audio modes: STEREO/JOINT STEREO/DUAL CHANNEL/MONO/VBR

- MPEG1 Audio Layer III (MP3)
- Sampling frequency: 32/44.1/48 kHz
- Bit rate: 32–320 kbps

■ WAV playback specifications

Sampling frequency: 8/11.025/12/16/22.05/24/32/44.1/48 kHz

Quantization bit rate: 8-bit/16-bit

■ CD playback specifications

Sampling frequency: 44.1 kHz

Quantization bit rate: 16-bit

Number of channels: 2

■ Audio characteristics

Frequency characteristics: 20 Hz – 20 kHz ± 0.8 dB

S/N ratio: 98 dB (20 kHz LPF, A-weighted)

Distortion (THD+N): 0.006% (1 kHz: 20 kHz LPF)

Dynamic range: 96 dB (20 kHz LPF, A-weighted)

Channel separation: 90 dB (1 kHz: 1 kHz BPF)

Cassette tape

■ Track system

4-track 2-channel stereo

■ Head structure

Record/playback x 1 (rotary reverse), erase x 1

■ Usable tape types

C-46 – C-90 type cassette tapes (metal tapes can only be played back)

■ Tape speed

4.76 cm/sec

■ Pitch control range

$\pm 10\%$ or more

■ Wow and flutter

0.25% (JIS WRMS) or less

■ Rewind time

160 seconds or less (C-60 tape)

■ Recording and playback frequency characteristics

Normal (type): 30 Hz – 13 kHz ± 4 dB

Chrome (type): 30 Hz – 15 kHz ± 4 dB

■ Recording and playback channel separation

1 kHz: 35 dB or more (1 kHz, using BPF)

■ Recording and playback S/N ratio

58 dB (Maximum input level, A-Weighted)

■ Recording and playback distortion

2.5% or less

Analog audio

CD player section

■ CD LINE OUTPUT [UNBALANCED] jacks

Analog unbalanced output

Connector: RCA pin jacks

Standard output level: -10 dBV

Maximum output level: $+6$ dBV

Output impedance: 200 Ω

Cassette tape section

■ TAPE LINE OUTPUT [UNBALANCED] jacks

Analog unbalanced output

Connectors: RCA pin jacks

Standard output level: -4.5 dBu

Output impedance: 200 Ω

■ TAPE LINE INPUT [UNBALANCED] jacks

Analog unbalanced input

Connectors: RCA pin jacks

Standard input level: -9 dBu

Minimum input level: -19 dBu

Input impedance: 22 k Ω

11 – Specifications

Headphones section

■ PHONES jack

Headphones output

Connector: standard stereo jack

Rated output: 20 mW + 20 mW or more (during CD monitoring, THD+N 0.1% or less, 32Ω load)

Digital audio

CD player section

■ CD DIGITAL OUTPUT [COAXIAL] jack

Connector: RCA pin jack

Compatible signal format: S/PDIF (IEC-60958-3 standard for consumer applications)

Output impedance: 75Ω

General

- Power: AC 120 V, 60 Hz (U.S.A./Canada)
- Power consumption: 14 W
- External dimensions: 483 x 138.5 x 290 mm (width x height x depth, including protrusions)
- Weight: 6.3 kg

NOTE

- Some of the illustrations in the Owner's Manual might differ from the actual equipment.
- Specifications and appearance might be changed without notification for product improvement.

Dimensional drawing

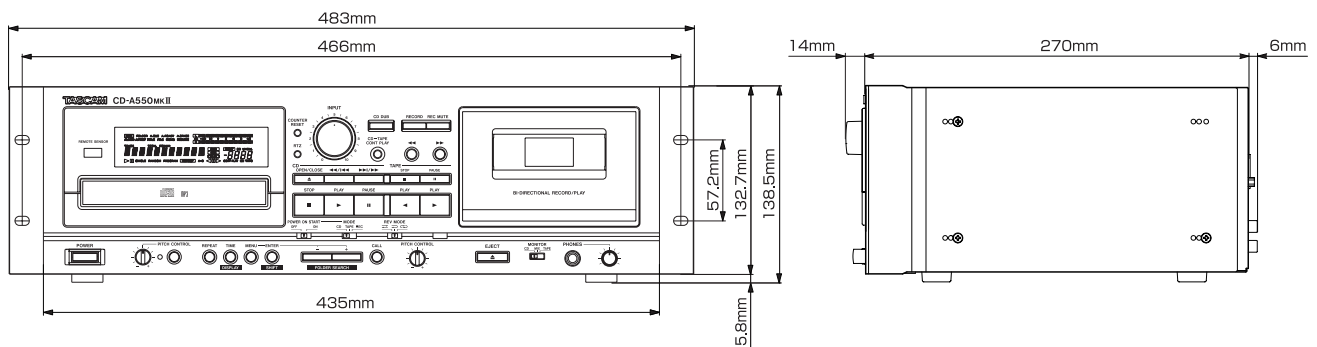

WARRANTY

< In the United States >

This warranty gives you specific legal rights and you may also have other rights which vary from state to state. This warranty is only valid within the country the unit was originally purchased.

WHAT IS AND IS NOT COVERED

Except as specified below, this warranty covers all defects in materials and workmanship in this product. The following are not covered by the warranty:

1. Damage to or deterioration of the external cabinet.
2. Damages resulting from accident, misuse, abuse or neglect.
3. Damage resulting from failure to perform basic daily maintenance and/or calibration or otherwise resulting from failure to follow instructions contained in your owner's manual.
4. Damage occurring during shipment of the product. (Claims must be presented to the carrier)
5. Damage resulting from repair or attempted repair by anyone other than TEAC or an authorized TASCAM service station.
6. Damage resulting from causes other than product defects, including lack of technical skill, competence, or experience of the user.
7. Damage to any unit which has been altered or on which the serial number has been defaced, modified or is missing.

WHO MAY ENFORCE THE WARRANTY

This warranty may be enforced only by the original purchaser.

LENGTH OF WARRANTY

All parts except heads and disk drives are warranted for one (1) year from the date of original purchase. Heads and disk drives are warranted to ninety (90) days from date of original purchase. Labor is warranted for ninety (90) days from date of original purchase.

WHAT WE WILL PAY FOR

We will pay all labor and material expenses for items covered by the warranty. Payment of shipping charges is discussed in the next section of this warranty.

HOW YOU CAN GET WARRANTY SERVICE

Your unit must be serviced by an authorized TASCAM service station in the United States. (This warranty is not enforceable outside the U.S.) If you are unable to locate an authorized TASCAM service station in your area, please contact us. We either will refer you to an authorized service station or instruct you to return the unit to the factory. Whenever warranty service is required, you must present a copy of the original dated sales receipt from an Authorized TASCAM Dealer.

You must pay any shipping charges if it is necessary to ship the product to service. However, if the necessary repairs are covered by the warranty, we will pay return surface shipping charges to any destination within the United States.

LIMITATION OF IMPLIED WARRANTIES

Any implied warranties, INCLUDING WARRANTIES OF MERCHANTABILITY AND FITNESS FOR A PARTICULAR PURPOSE, are limited in duration to the length of this warranty.

EXCLUSION OF DAMAGES

TEAC's liability for any defective product is limited to repair or replacement of the product, at TEAC's option. TEAC shall not be liable for:

1. Damages based upon inconvenience, loss of use of the product, loss of time interrupted operation or commercial loss; or
2. Any other damages, whether incidental, consequential or otherwise.

Some states do not allow limitations on how long an implied warranty lasts and/or do not allow the exclusion or limitation of incidental or consequential damages, so the above limitations and exclusions may not apply to you.

To locate an Authorized Service Center in Your Area

CALL 1-800-447-8322

< Europe >

This product is subject to the legal warranty regulations of the country of purchase. In case of a defect or a problem, please contact the dealer where you bought the product.

Ce produit est sujet aux réglementations concernant la garantie légale dans le pays d'achat. En cas de défaut ou de problème, veuillez contacter le revendeur chez qui vous avez acheté le produit.

Dieses Gerät unterliegt den gesetzlichen Gewährleistungsbestimmungen des Landes, in dem es erworben wurde. Bitte wenden Sie sich im Gewährleistungsfall an den Händler, bei dem sie das Gerät erworben haben.

Questo apparecchio è conforme alle norme sulla garanzia vigenti nel rispettivo Paese in cui esso è stato acquistato. Si prega di rivolgersi al proprio commerciante, presso il quale è stato acquistato l'apparecchio, nel caso in cui si voglia richiedere una prestazione in garanzia.

Las condiciones de garantía de este aparato están sujetas a las disposiciones legales sobre garantía del país en el que ha sido adquirido. En caso de garantía, debe dirigirse al establecimiento donde adquirió el aparato.

< In other countries/areas >

This warranty gives you specific legal rights, and you may also have other rights that vary by country, state or province.

If you have a warranty claim or request, please contact the dealer where you bought the product.

该保证书赋予了顾客特定的合法权利，并且因国家、州或省等地域的不同，顾客可能拥有其他权利。如需申请或要求保修，请与购买本产品的销售店进行联系。

If you require repair services for your TASCAM equipment, please contact the dealer where the product was purchased from or the TASCAM Distributor in your country. A list of TASCAM Distributors can be found on our website at: <http://teac-global.com/>

TASCAM

TEAC CORPORATION

Phone: +81-42-356-9143

1-47 Ochiai, Tama-shi, Tokyo 206-8530 Japan

<http://tascam.jp/>

TEAC AMERICA, INC.

Phone: +1-323-726-0303

1834 Gage Road, Montebello, California 90640 USA

<http://tascam.com/>

TEAC MEXICO, S.A. de C.V.

Phone: +52-55-5010-6000

Río Churubusco 364, Colonia Del Carmen, Delegación Coyoacán, CP 04100, México DF, México

<http://teacmexico.net/>

TEAC UK LIMITED

Phone: +44-8451-302511

Meridien House, Ground Floor, 69 - 71, Clarendon Road, Watford, Hertfordshire, WD17 1DS, UK

<http://tascam.eu/>

TEAC EUROPE GmbH

Phone: +49-611-71580

Bahnstrasse 12, 65205 Wiesbaden-Erbenheim, Germany

<http://tascam.eu/>

TEAC SALES & TRADING(SHENZHEN) CO., LTD

Phone: +86-755-88311561~2

Room 817, Block A, Hailrun Complex, 6021 Shennan Blvd., Futian District, Shenzhen 518040, China

<http://tascam.cn/>

Printed in China

WARRANTY

Model/Modèle/Modell
Model/Modèle/Modell

Sample
CD-A55DMK II

Owner's name/Nom du possesseur/Name des Eigentümers
Nome del proprietario/Nombre del propietario/顾客姓名

Serial No./No. de Série/Seriennummer
Numero di serie/Número de serie/序列号

Address/Adresse/Adresse
Indirizzo/Dirección/顾客地址

Date of purchase/Date de l'achat/Datum des Kaufs
Data dell'acquisto/Fecha de compra/购买日期

Dealer's name/Nom du détaillant/Name des Händlers
Nome del commerciante/Nombre del establecimiento/销售店名

TASCAM
<http://teac-global.com/>

Dealer's address/Adresse du détaillant/Adresse des Händlers
Indirizzo del commerciante/Dirección del establecimiento/销售店地址